

MOOSE Z1250

Security System Control

MOOSE 

A PRODUCT OF SENTROL, INC

Sentrol, Inc. reserves the right
to change specifications
without notice.

©1995 Sentrol, Inc.

64812670B

User Guide

Contents

Guidelines

1. Read this entire manual and keep it in a secure place.
2. The system must be tested at least once per week to ensure proper operation. Contact your security representative for testing procedures and scheduling of a regular maintenance program.
3. If the system is malfunctioning, have it serviced by a qualified professional as soon as possible.
4. If the electrical system of the building is altered, be sure that the changes do not create an interruptible power supply to the control panel.
5. If the telephone system is serviced, test the security system to ensure that communication to the central station is intact.
6. No security system can detect intrusion or other emergency conditions in all circumstances. Your security representative can instruct you on the capabilities of your system and may recommend future upgrades for the system.
7. Motion detectors are designed to detect specific types of motion within a defined area. Be sure that you understand which areas are protected and under what conditions the system is active (temperature and time variations, etc.).
8. Smoke detection devices cannot detect all types of fire under all circumstances. Have your security representative explain the limitations of your fire system. Have smoke detectors cleaned and tested on a regular basis.
9. Security systems rely upon AC as a primary power source. When AC fails, the control is powered by a standby battery. The standby battery is automatically checked by the system and should be replaced by a qualified service technician at regular intervals.
10. The system can be armed without AC power. The system could then fail if the battery voltage falls below the acceptable range before AC power is restored. It is possible to arm the system with the standby battery disconnected.
11. In the event of a trouble indication, contact your security representative immediately to determine the nature of the trouble condition.
12. If upon returning to the building, you discover that an alarm has occurred, **DO NOT ENTER THE PREMISES**. Immediately contact the proper authorities.
13. Be sure to inform your neighbors that a security system has been installed. Also explain the meanings of the various audible signals and ask them to contact the appropriate authorities upon activation of an alarm.
14. UL requires that audible burglar alarms be distinct in sound from fire alarms. For combination burglar and fire alarm systems, the sounder may emit a steady tone for fire alarms and a pulsing tone for burglar alarm signals. Fire alarm signals take priority.
15. UL requires that exit times not exceed 60 seconds. Entrance times may not exceed 45 seconds. Cutoff time for siren/bell cannot be less than 4 minutes for residential fire and burglary and 15 minutes for commercial burglary.
16. This equipment is suitable for UL Grade A Household Burglary Applications.

1.0 Introduction	2
2.0 LCD Overview	3
3.0 Normal Arming & Disarming	4
3.1 To Arm	4
3.2 To Disarm	5
4.0 System Not Ready To Arm	6
4.1 Option 1: Force Arming	6
4.2 Option 2: Bypassing	8
5.0 Quick Commands	10
5.1 Quick Arming	10
5.2 Quick Disarming	11
5.3 Quick Arming Level Change	12
5.4 Quick Force Arming	13
6.0 What To Do If The Alarm Is Sounding	14
7.0 Trouble Conditions	15
7.1 Trouble Conditions When the System Is Disarmed	15
7.2 Trouble Conditions When the System Is Armed	16
8.0 Auxiliary Panic Keys	17
8.1 To Activate Panic Keys	17
8.2 To Silence And Reset Auxiliary Zones	17
9.0 Menu Features and Definitions	18
9.1 Functions Accessed by the First Menu Press	19
9.2 Functions Accessed by the Second Menu Press	20
9.3 Functions Accessed by the Third Menu Press	23
9.4 Functions Accessed by the Fourth Menu Press	26
10.0 User Codes	27
10.1 Programming User Codes	27
10.2 Deleting a User Code	30
10.3 Temporary Codes	31
10.4 Using a Duress Code	31
10.5 Access Control	31
11.0 LED Keypad Operation	32
12.0 Fire Detection	33
12.1 What To Do If The Fire Alarm Sounds	33
12.2 Testing the Fire System	33
Appendix I SCHEDULE EVENTS Definitions	34
Appendix II Fire Protection Information	37
Glossary	40

1.0

Introduction

By purchasing this security system, you have taken a major step toward protecting your home or business. Read these instructions carefully to familiarize yourself with the system. Your system has been custom designed to meet your specific requirements and may include features not discussed in this manual. Some features discussed are optional and may not be programmed in your particular system. If you have questions concerning the features on your system, consult your security installation representative.

Throughout this manual, a flowchart follows each section to review and clarify the procedure discussed in the text. Solid line-arrows indicate that the user is required to press the soft button beneath the word prompt indicated. Broken line-arrows indicate that the operation is carried out automatically by the system.

When you perform most operations on the system, you will be instructed to enter your passcode (user code). All passcodes are assigned an authority level. Your passcode must be of sufficient authority level to perform a given operation. Consult your installer for the authority levels applicable to user codes on your particular system.

Note: When performing operations on the system, if you make an error entering your user code, press the CLEAR key to clear the entry and start over. This procedure applies any time you are entering a user code.

2.0

LCD Overview

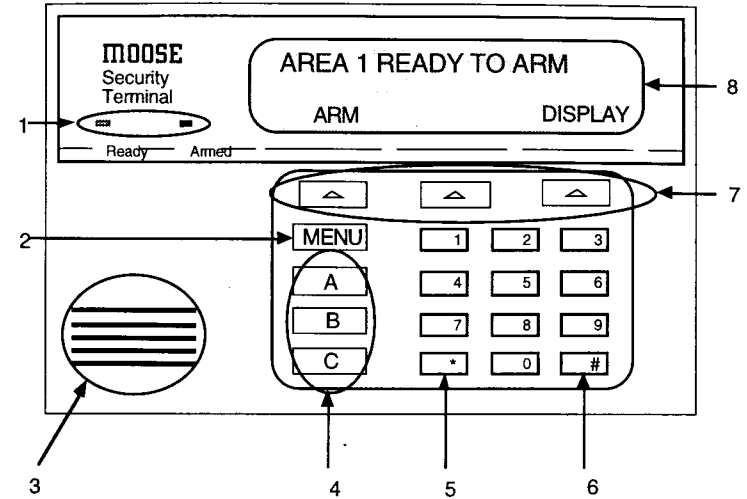

FIGURE 1 - LCD CONTROL STATION

- 1. Status Indicator**
 - Ready: On -System is ready to arm.
Off -System is not ready to arm.
 - Armed: On -Intrusion detection system is armed.
Off -Intrusion detection system is disarmed.
Blinking - A burglar alarm has occurred.
- 2. Menu Key** Allows the user to scroll through available menu options.
- 3. Keypad Audible** Sounds tones and alarms.
- 4. Auxiliary Panic Keys** Activates auxiliary alarms. May be used 24 hours a day, regardless of whether or not the system is armed.
- 5. Clear/Quit Key** Clears incorrect entries or returns to previous screen.
- 6. Enter Key** Causes the system to accept data after it is typed in or, when pressed from an idle keypad, causes the display of free-running time of day.
- 7. Soft Feature Keys** Allows the user to make selections from the LCD display screen.
- 8. LCD Display** Displays system status and menu options.

3.0 Normal Arming & Disarming

When the system is disarmed and all zones are secure (all contacted doors, windows, etc. closed), the LCD displays AREA 1 READY TO ARM. Since the area name "AREA 1" is often customized at the time of installation, your display may be slightly different. For example, the LCD on your system may display SMITH RES READY TO ARM.

3.1 To Arm

1. Press the ARM soft key. The display prompts you to ENTER PASSCODE.
2. Enter your user code. As you enter each digit, cursor blocks appear above the ENTER prompt. Press the ENTER soft key.
3. The LCD now displays the ARMING LEVEL prompt:
 - **AWAY** Completely arms all detection devices.
 - **STAY** Arms only perimeter zones while bypassing interior zones.
 - **NIGHT** Arms all perimeter and specified interior zones. (This is an optional customized arming level. Ask your installer for details about your system's capabilities.)
4. Press the soft key beneath the desired level of arming. The screen briefly displays the selected arming level (AREA 1 ARMING: AWAY/ STAY/ NIGHT).

Next, the control station counts through the exit time with a visual display (XX SEC ARM WITH DELAY) and with audible beeps, if so programmed. While the exit time counts down, the INSTANT soft key appears. When it is selected, the exit time is halted and the system arms on INSTANT, i.e., the entry time is disabled. (An entry time is a programmed "pause" that occurs before the system trips an alarm after an entry zone is violated. It is designed to allow the user to enter and disarm the system without causing an alarm).

When the exit time expires, the screen displays AREA 1 ARMED and gives the DISARM prompt. Depending on the available options and the arming level selected, the display may reflect the type of arming selected. Possible displays are:

- **ARMED** Armed with the AWAY option and an entry time.
- **ARMED INST** Armed AWAY with no entry time.
- **ARMED STAY** Perimeter zones armed and interior zones bypassed, with an entry time.
- **ARMED STAY INST** Perimeter zones armed with no entry time.

- **ARMED NITE** Perimeter and selected interior zones armed with entry time.
- **ARMED NITE INST** Perimeter and selected interior zones armed with no entry time.

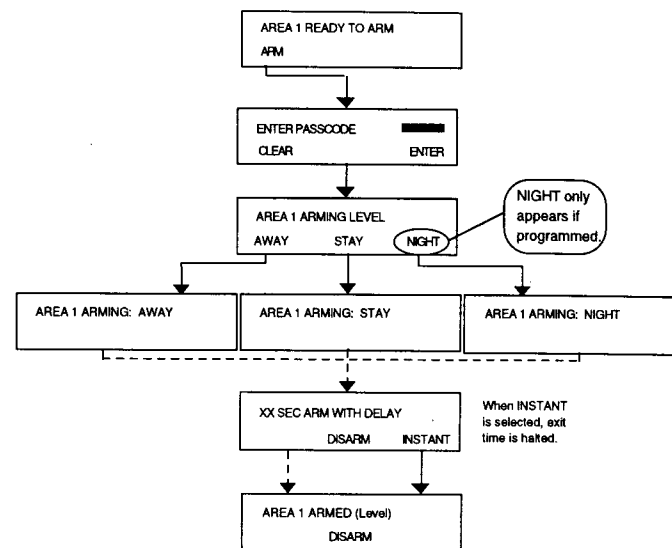

FIGURE 2 - NORMAL SYSTEM ARMING

3.2 To Disarm

Select the DISARM soft key. At the ENTER PASSCODE prompt, enter your user code and press the ENTER soft key. The system disarms and displays AREA 1 READY TO ARM

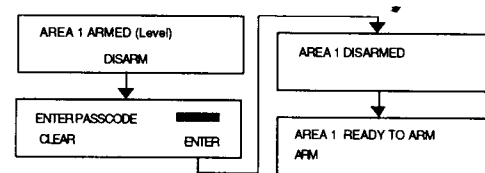

FIGURE 3 - NORMAL SYSTEM DISARMING

Note: The system may be armed with the installer passcode. The system may be disarmed with the installer passcode only if it was used to arm the system in the first place.

4.0 System Not Ready To Arm

When one or more intrusion zones are faulted (a contacted door or window is not properly closed, for example), the LCD indicates AREA 1 NOT READY and gives you the option to DISPLAY the name of each faulted zone.

1. Press DISPLAY to see which zone is faulted. If more than one zone is faulted, press NEXT to display the other violated zone(s) consecutively. When all zones are identified, press QUIT.
2. Attempt to secure the faulted zone(s) by checking appropriate doors, windows, etc.
3. If you are unable to secure the faulted zone(s), two options may be available, if they are programmed in your particular system. Check with your installer to find out what features are enabled on your system.

4.1 Option 1: Force Arming

If this programming option is enabled, after you select ARM, enter your passcode and select the arming level, the display indicates that the system is not ready and gives you the option to FORCE the system to arm.

Force arming causes the system to arm regardless of which zones are faulted. Once a faulted zone is secured, that zone is automatically armed and will cause an alarm if it is violated again.

Example of a Force Arm

You are leaving for work in the morning and the garage door is open so you can back your car out. You go ahead and force arm the system. Then you leave for work, closing the garage door behind you. That zone arms as soon as the door closes. If you open the garage door again without following the proper disarming procedure, it will cause an alarm.

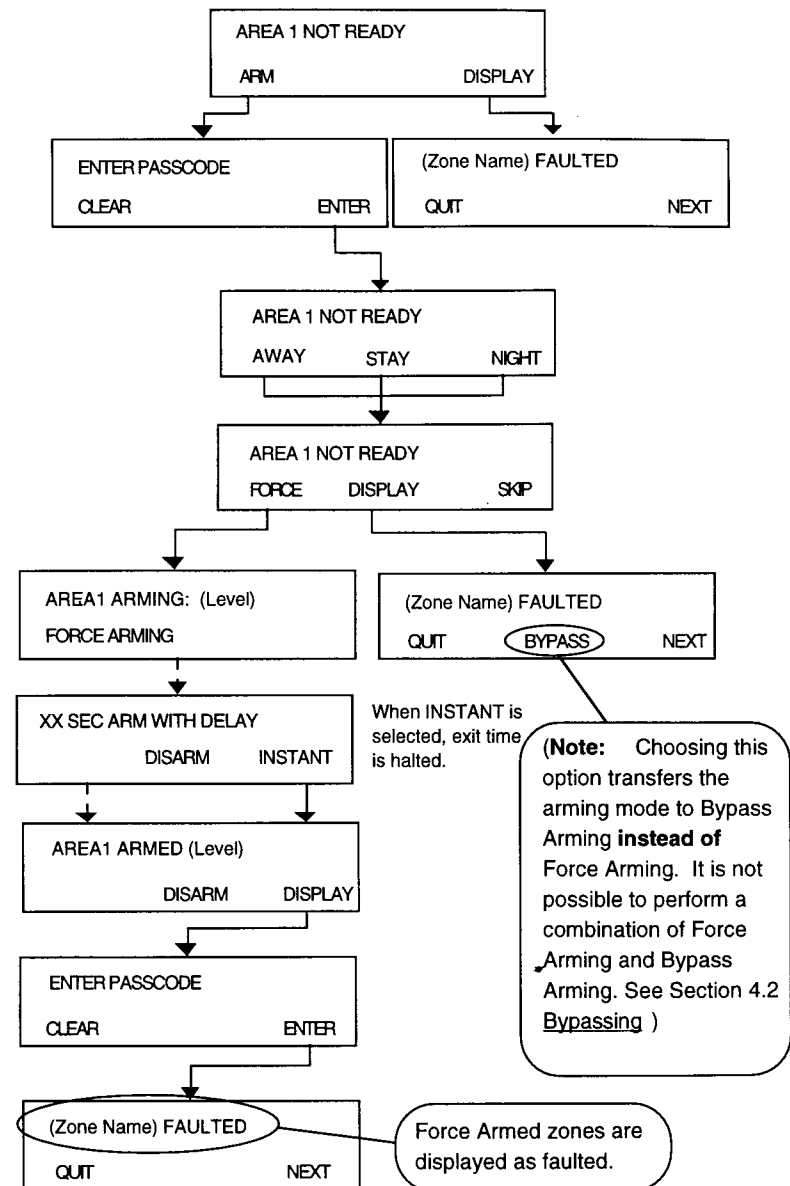

FIGURE 4 - FORCE ARMING

4.2 Option 2: Bypassing

If this programming option is enabled, after you select ARM, enter your passcode and select the arming level, the display indicates that the system is not ready and gives you the option to DISPLAY the violated zones. This display screen is where you get the option to BYPASS faulted zones.

While force arming automatically arms "around" all faulted zones, bypassing must be performed manually zone by zone. Bypassing also differs from force arming in that once a zone is bypassed, it is bypassed for the entire length of the armed period. To remove a bypass, you must disarm the system.

Note: Bypassing zones reduces the degree of security designed for your building. Do not instruct temporary users how to employ this function.

Example of a Bypass

On the first real spring day of the year, you decide that you would like to leave the upstairs windows open to air out the bedrooms and let in some fresh air. However, you still want to arm the security system when you leave for work. So you bypass all the zones with open windows. When you come home that evening and disarm the system, the bypasses are automatically removed.

For information on bypassing zones that are not faulted, refer to the VIEW STATUS menu feature in Section 9.1 of this manual.

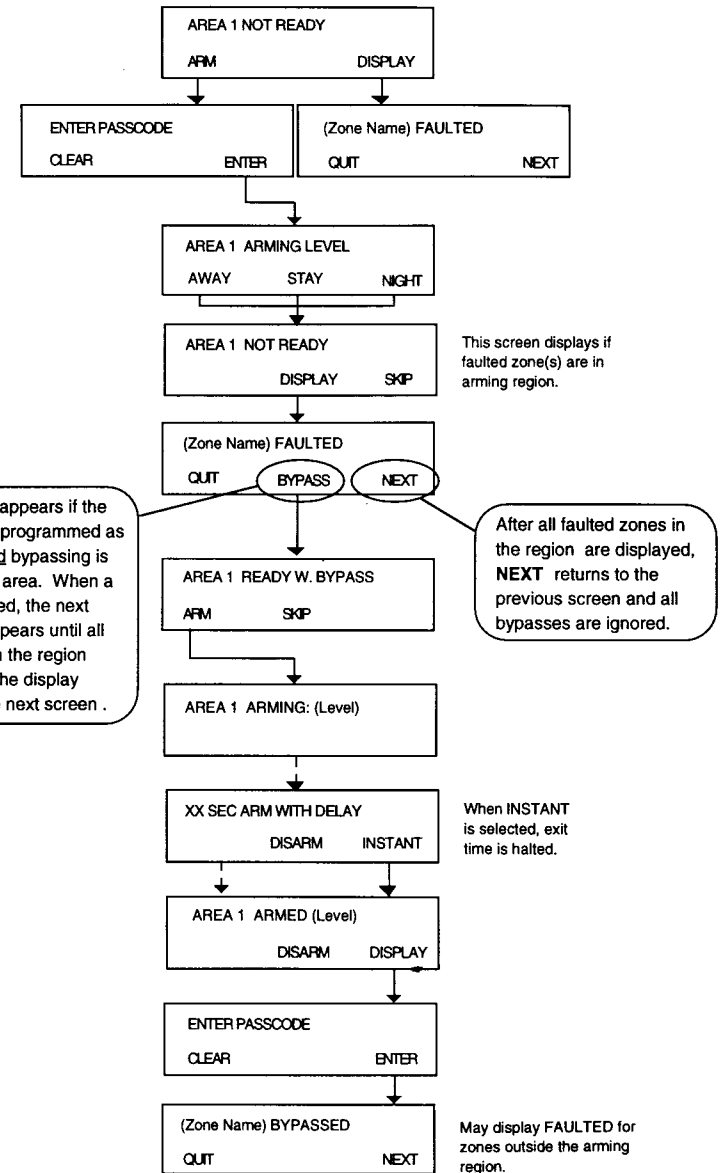

FIGURE 5 - BYPASSING

5.0 Quick Commands

Quick Commands are included in this system as a convenience feature. They enable the engaging of certain functions with fewer keystrokes than the conventional procedure. The following paragraphs outline the procedures for Quick Arming, Quick Disarming, Quick Arming Level Change and Quick Force Arming.

5.1 Quick Arming

From the idle (disarmed) LCD menu screen, enter your user passcode without pressing the ARM soft key. Finish arming the system as you normally would.

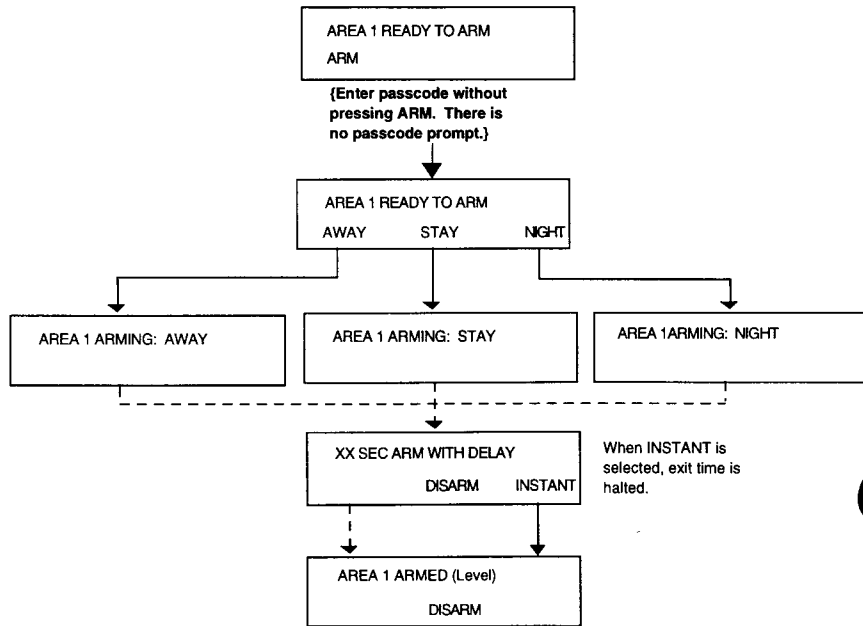

FIGURE 6 - QUICK ARMING

5.2 Quick Disarming

From the armed LCD menu screen, enter your user passcode without pressing the DISARM soft key. Then press the DISARM soft key.

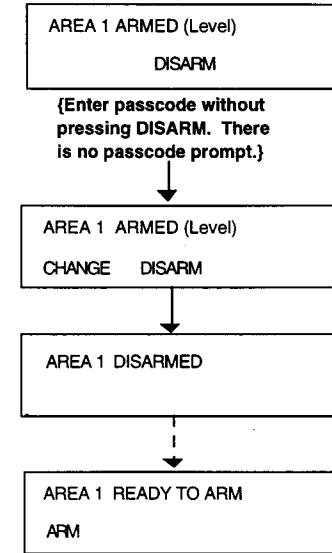

FIGURE 7 - QUICK DISARMING

5.3 Quick Arming Level Change

You may occasionally wish to change the system's arming level (AWAY, STAY, NIGHT) while the system is armed. Unlike many security systems, this system has a feature that allows you to change the arming level without completely disarming and then rearming the system.

From the armed LCD screen, enter your user code without pressing DISARM. Press the CHANGE soft key. Choose the new arming level and continue with the normal arming procedure as shown in the following figure.

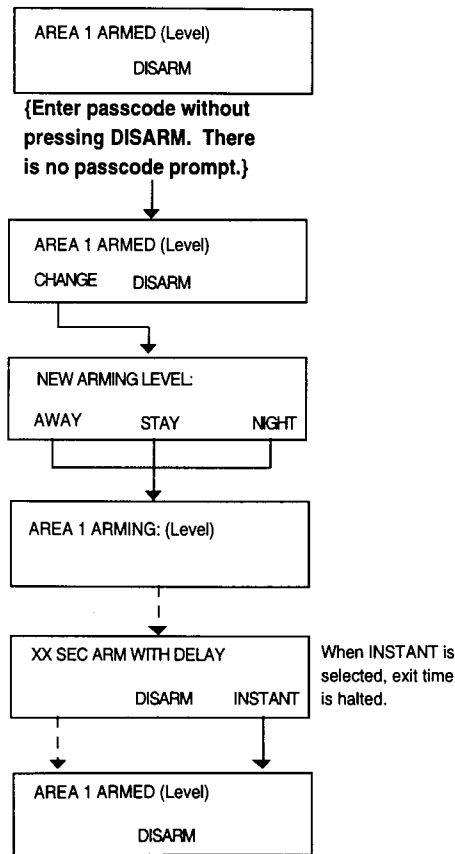

FIGURE 8 - QUICK ARMING LEVEL CHANGE

5.4 Quick Force Arming

To Quick Force Arm the system, enter your user code without pressing ARM. Choose the arming level as you would in a regular arming procedure. When the system displays NOT READY TO ARM, press the “#” key to force arm the system, i.e., to arm the system “around” the faulted zones. See Section 4.1 for review of Force Arming.

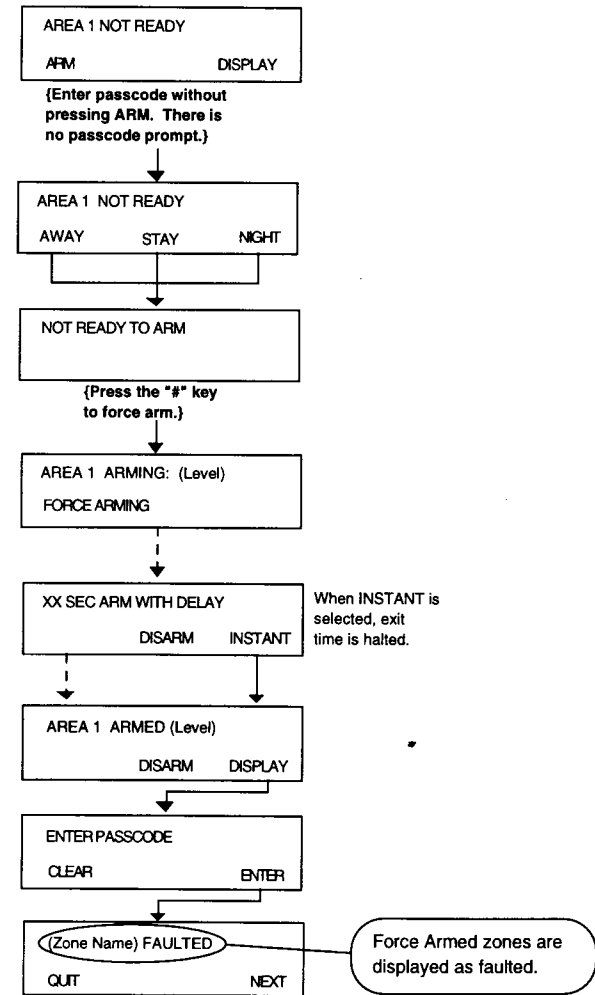

FIGURE 9 - QUICK FORCE ARMING

6.0 What To Do If The Alarm Is Sounding

The display indicates that an intrusion has occurred.

1. Press SILENCE.
2. Enter your user code. If you make an error entering your code, press CLEAR and reenter the code.
3. Press the soft key corresponding to ENTER. The LCD then displays the first zone that went into alarm.
4. Press the soft key corresponding to TIME to display the time and date that the system alarmed. Press QUIT to exit and return to normal LCD display.

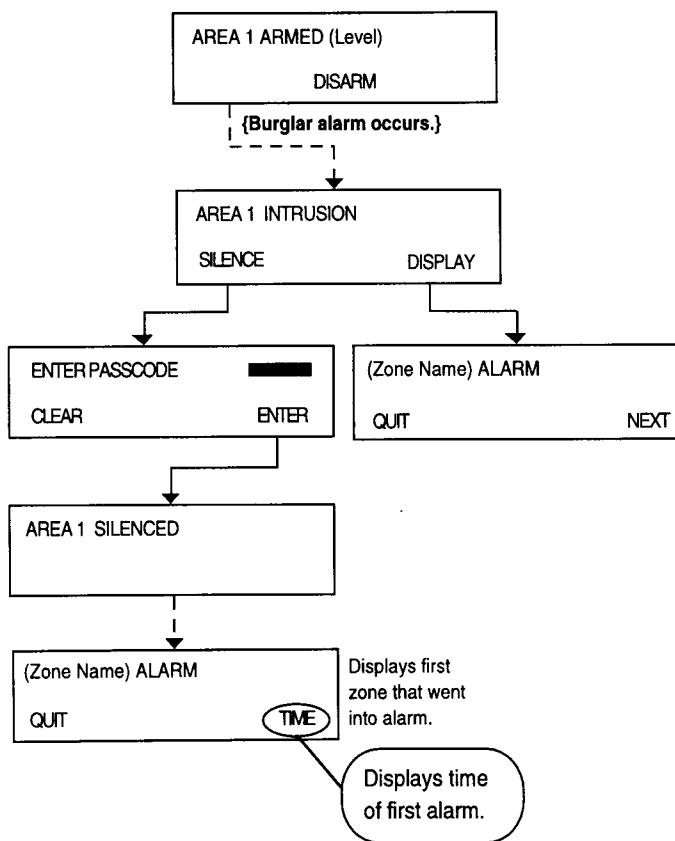

FIGURE 10 - SILENCING AN ALARM

7.0 Trouble Conditions

If a trouble condition exists, the LCD blinks back and forth between a system trouble message and the area's status. Some trouble conditions also produce an audible alarm. When more than one trouble condition is present, the display scrolls through the trouble conditions and the area's status, pausing two seconds for each item displayed. System trouble messages include MISSING KEYPAD (a control station has been removed or is not functioning), FIRE CIRCUIT TROUBLE (a fire system wire is broken), LOW BATTERY/BLOWN FUSE, AC POWER FAILURE, etc.

7.1 Trouble Conditions When the System Is Disarmed

When the LCD scrolls through troubles and status, pressing DISPLAY defines the problem. The SILENCE prompt only appears if the trouble condition is one that causes an audible alert tone. See the following diagrams for detailed procedure steps. After the trouble condition from a Missing Keypad, Communication Failure or Memory Error has been SILENCED, the trouble condition may be cleared by pressing and holding the "*" key for three seconds.

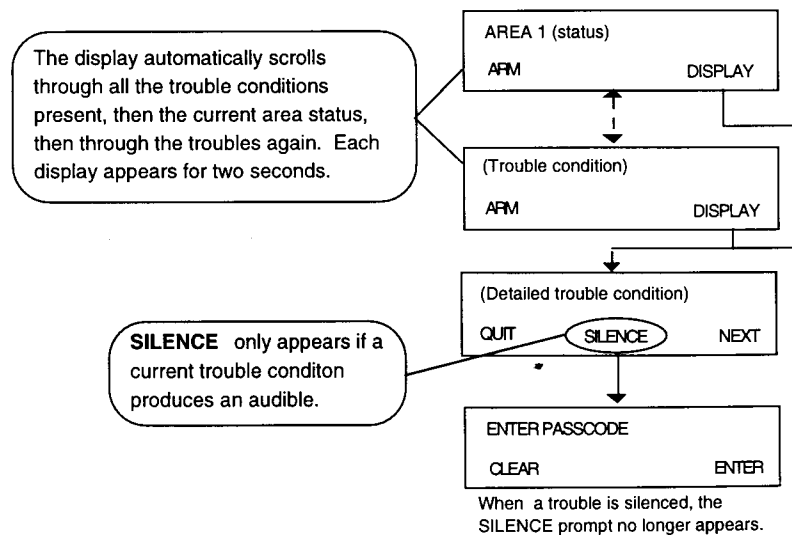

FIGURE 11 - DEFINING A TROUBLE CONDITION

7.2 Trouble Conditions When the System Is Armed

Defining trouble conditions when the system is armed requires a slightly different procedure. It is necessary to enter a user code before the system displays the detailed trouble condition(s). However, in this procedure, entering the user code automatically silences all audible alert tones. Therefore, the SILENCE prompt does not appear on the detailed trouble screen.

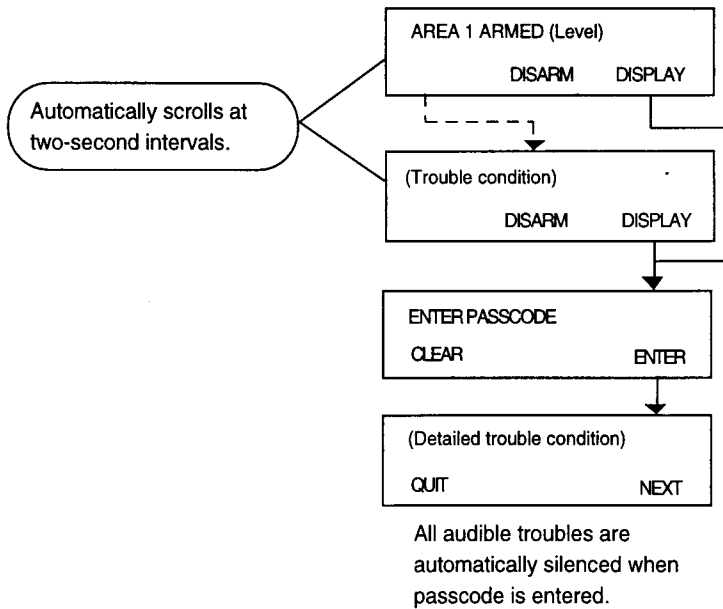

FIGURE 12 - TROUBLE CONDITIONS WHEN THE SYSTEM IS ARMED

8.0 Auxiliary Panic Keys

The three keys on the left side of the keypad face are Auxiliary Panic Keys. The functions activated by these keys have various uses. Most are used as distress signals and always work regardless of whether or not the system is armed. These keys can be programmed to activate different types of alarms. The keys may be assigned as follows:

- **Burglar Alarm** - may activate silently with a visual display or with both audible and visual alarm indications, depending on programming.
- **Fire Alarm** - activates with audible and visual alarm indications. See Section 12.2 [Testing the Fire System](#).
- **Holdup Alarm** - may activate silently with no visual display or with both audible and visual alarm indications, depending on programming.
- **Medical Alarm** - activates with audible and visual alarm indications.

To determine when or if to use these keys on your system, refer to the [System Reference Guide](#) at the end of this manual for the assignments of these keys. Consult your installer for a full explanation of the programming enabled for these keys on your system.

8.1 To Activate Panic Keys

Press Auxiliary Panic Key A, B, or C. The activation may be instant or you may have to hold the key down for three seconds, depending on programming.

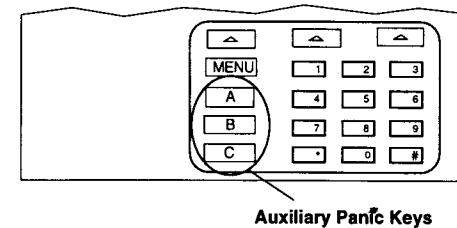

FIGURE 13 - AUXILIARY PANIC KEYS

8.2 To Silence And Reset Auxiliary Zones

1. Notify the central station or the appropriate authorities immediately if an alarm was activated unintentionally.
2. Press SILENCE and enter your code when prompted.
3. Press the soft key corresponding to ENTER.

Note: To reset a silent holdup alarm, you must access the RESET ALARM menu. See the menu feature definitions in Section 9.1.

9.0 Menu Features and Definitions

The system has menu selections that enable you to perform a variety of functions, including user level programming. The menu key allows you to scroll through the available options.

Note: Flowcharts detail the procedures for accessing the menu features described in this chapter. Remember that solid line-arrows indicate that the soft key below a particular option must be pressed. Broken line-arrows indicate that the system carries out an operation automatically.

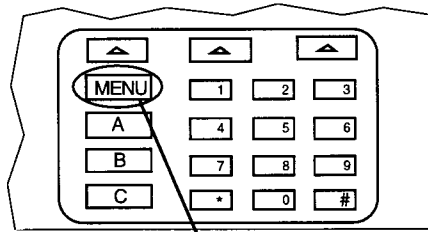

FIGURE 14 - MENU KEY

Each time you press the menu key, a new selection of options appears on the LCD screen. Pressing the soft key below an option activates that function. After you select an option, the display prompts you to ENTER PASSCODE. After you enter your user code, additional sub-menus may appear. These sub-menus are defined in the following sections. You can return to the status screen from the menu screens by pressing the "*" key.

Note: When an area is armed or in alarm, only the first level of menu options ("First Menu Press") is accessible.

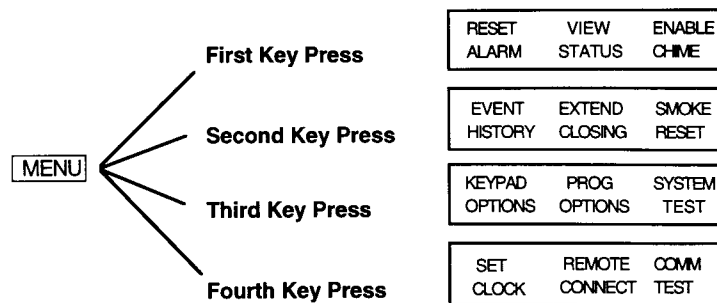

FIGURE 15 - MAIN MENU SCREENS

9.1 Functions Accessed by the First Menu Press

RESET ALARM : Resets silent Holdup Alarms only. You must perform this function or a disarm of the entire area to get a new Holdup Alarm. See Chapter 8.0 for a review of Holdup Alarms.

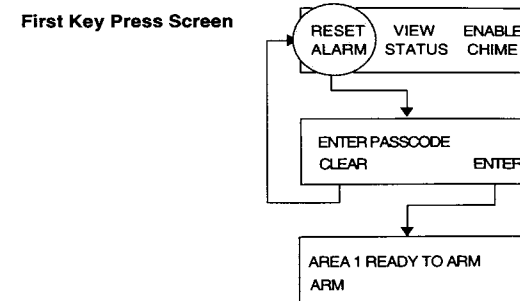

FIGURE 16 - RESET ALARM PROCEDURE

VIEW STATUS : Allows you to view the status of each zone and area. While viewing zone status, you may be permitted to bypass any zones defined as bypassable. See Section 4.2 for a review of Bypassing.

Example of Bypassing a Zone That is Not Faulted

You have a large dog that you want to keep inside on a cold day while you are at work. So you close the dog in the basement rec room, but you are worried that he might set off the motion detector there. So you bypass that zone to prevent a false alarm. When you return from work and disarm the system, the bypass is automatically removed.

Note: Bypassing burglary zones in armed areas is not permitted. You must disarm first, bypass the zone, and then rearm.

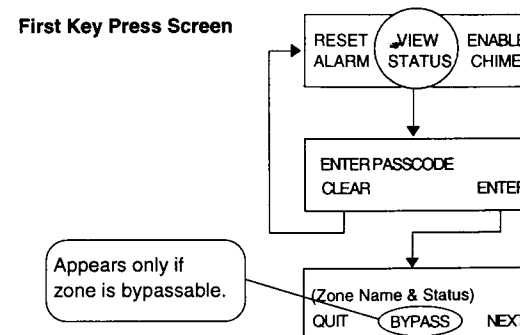

FIGURE 17 - VIEW STATUS PROCEDURE

ENABLE CHIME: Provides an audible annunciation from the control station(s) when certain doors and/or windows in the protected area are opened while the system is disarmed. The feature is commonly used for residential door annunciation or as customer entry notification in retail establishments. The display screen on this feature is similar to the status screen. Pressing the CHANGE soft key turns the chime on or off.

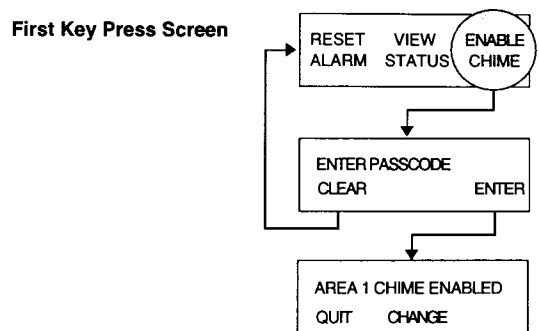

FIGURE 18 - ENABLE CHIME PROCEDURE

9.2 Functions Accessed by the Second Menu Press

EVENT HISTORY: Permits you to display a limited number of past events from the event memory log. This log displays events such as openings, closings, alarms, troubles, and accesses. Along with the type of event, the log contains information such as the date, time, user, zone, etc., associated with the event. Events are stored on a first-in/first-out basis. After pressing the EVENT HISTORY soft key and entering your user code, the LCD displays EVENT HISTORY with menu choices QUIT, PRINT, and DISPLAY.

QUIT: Resets system.

PRINT: Allows you to print the history data on an external printer if your system is equipped with one.

DISPLAY: Displays the history data on the LCD. It prompts START WITH MOST RECENT? with menu choices QUIT, YES, and NO.

QUIT: Returns display to previous screen.

NO: Prompts you for the date that the list should begin.

YES: Lists the events beginning with the most recent. When the desired event is displayed on the screen, additional information such as such as user name, zone name, date, and time may be viewed by pressing and holding the DISP key.

Note: The Event History displays only the events occurring in the area(s) accessible to the user code entered.

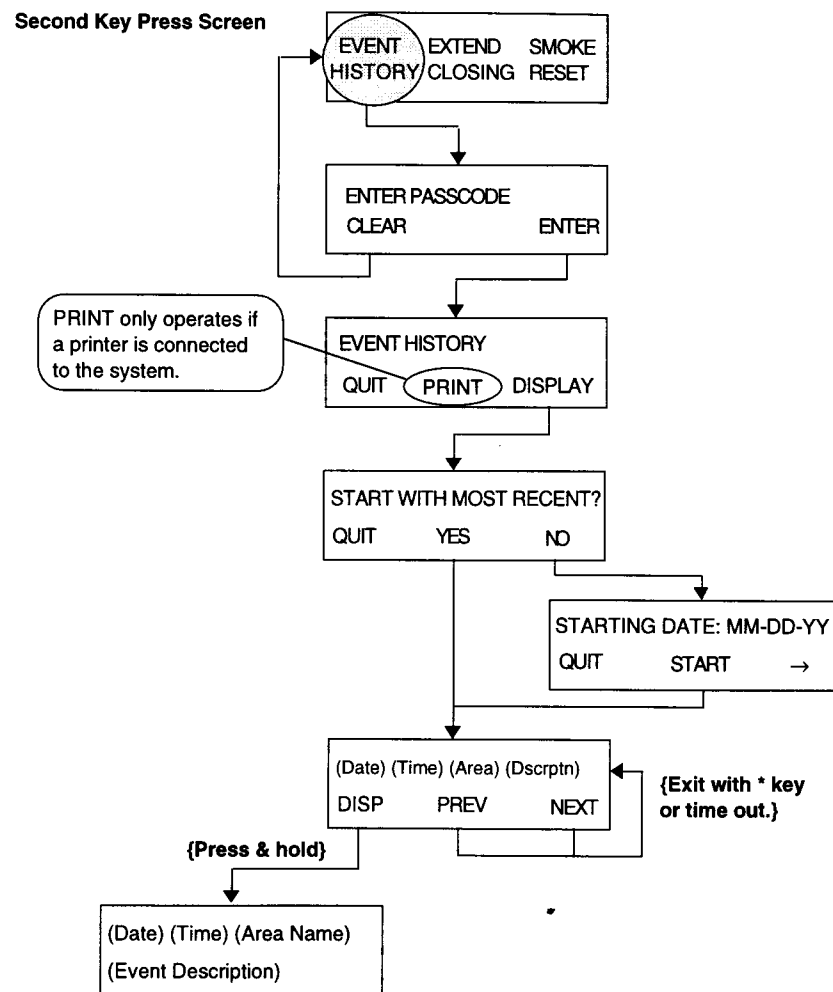

FIGURE 19 - EVENT HISTORY PROCEDURE

EXTEND CLOSING: Permits you to delay the Auto Arm time by one hour or extend the Late to Arm window by one hour. **Extend Closing can only be activated once per day and can never extend past midnight.** Activation of this function is reported to the central station and is posted in the event log. Consult your installer for details of this function as it applies to your system.

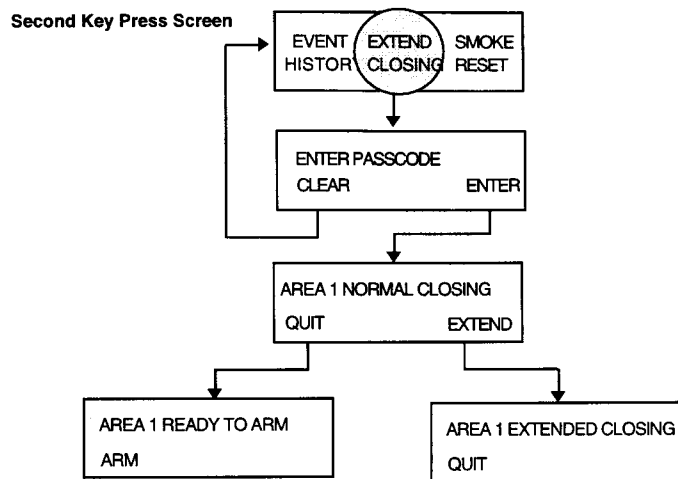

FIGURE 20 - EXTEND CLOSING PROCEDURES

SMOKE RESET: Allows you to reset the smoke detectors after an alarm. If the alarm continues or reoccurs after a reset attempt, contact your installation company.

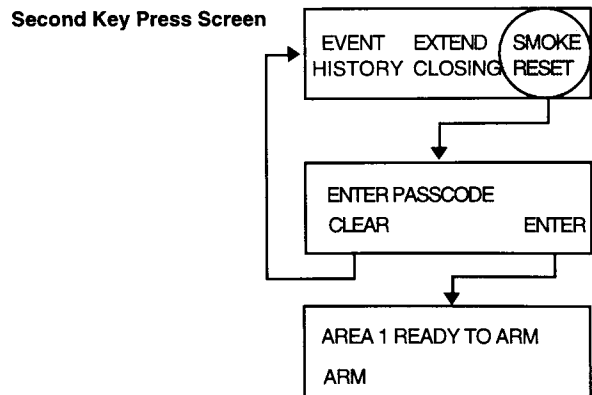

FIGURE 21 - SMOKE RESET PROCEDURE

9.3 Functions Accessed by the Third Menu Press

KEYPAD OPTIONS: Allows you to adjust beeps, adjust lamp, and change the viewing angle of the screen for the keypad in use. Lamp adjustments may not be operational on some keypads. The AC Fail Light lamp adjustment allows you to set a keypad to provide light during a power failure or to be dim to conserve the system's battery.

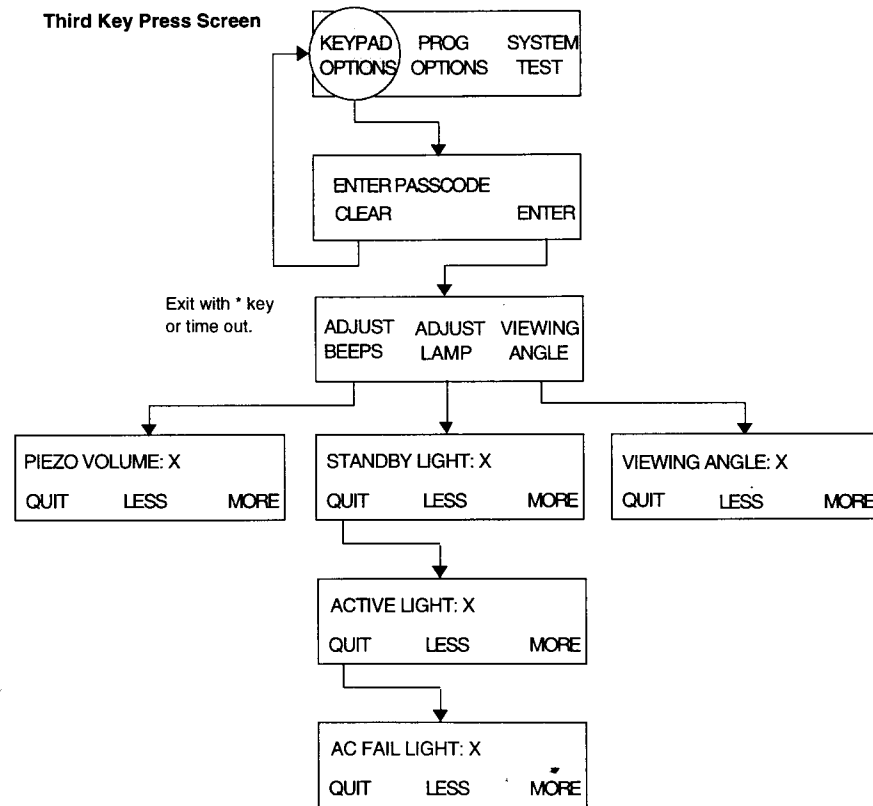

FIGURE 22 - KEYPAD OPTIONS PROCEDURE

PROG OPTIONS: The master user code is required to access this option. Allows access to the following fields:

USER CODES: Allows you to set and change user codes. (See Chapter 10.0 User Codes)

SCHEDULE EVENTS: Allows the master user to set up or alter the schedule for the area's opening and closing times. The schedule is set up on a seven-day cycle. The control may be instructed to automatically arm and disarm the system or area or to expect the the user to arm and disarm within specified times in the schedule. Compliance or failure to comply is reported to the central station, provided the installer enables the necessary report code fields. (See Appendix I for detailed Schedule Events definitions.)

Note: Time is programmed in four-digit military time (noon = 1200; midnight = 2400). Days are selected as digits 1-7 (1 = Sunday).

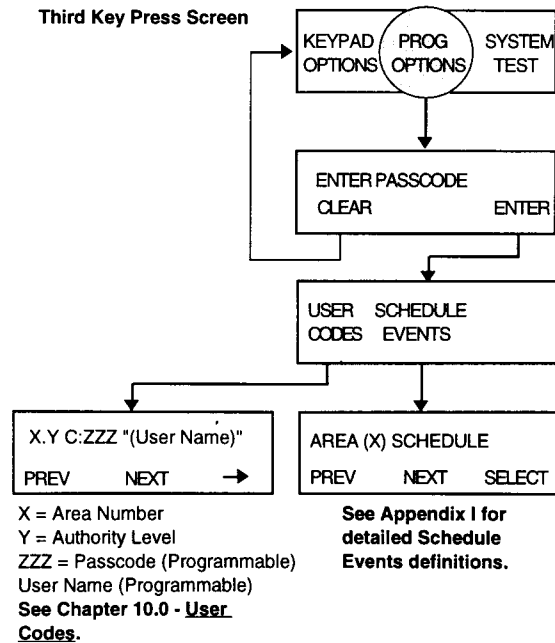

FIGURE 23 - PROGRAMMING OPTIONS PROCEDURE

SYSTEM TEST: Allows the testing of various aspects of the system. When you press this all audible and visual indicating devices (alarms, etc.) assigned to the area being tested activate for two seconds. The LCD displays the number of zones in the area that have been tested and the number of zones yet to be tested. To test a zone, you must violate that zone. Pressing the TESTED or UNTESTED soft keys displays the zone names. When you press the QUIT soft key all the pixels on the keypad's LCD briefly illuminate. Consult your installer for details regarding the local test procedure for your system. A SYSTEM TEST should be performed weekly on UL Listed Burglar systems.

Note: During a Local Test, all Fire Initiating Circuits report troubles to the central station. At the end of test mode, these zones report restorals. All zones activated during Local Test are recorded in the event log, but, with the exception of Fire Initiating Circuits, are not reported.

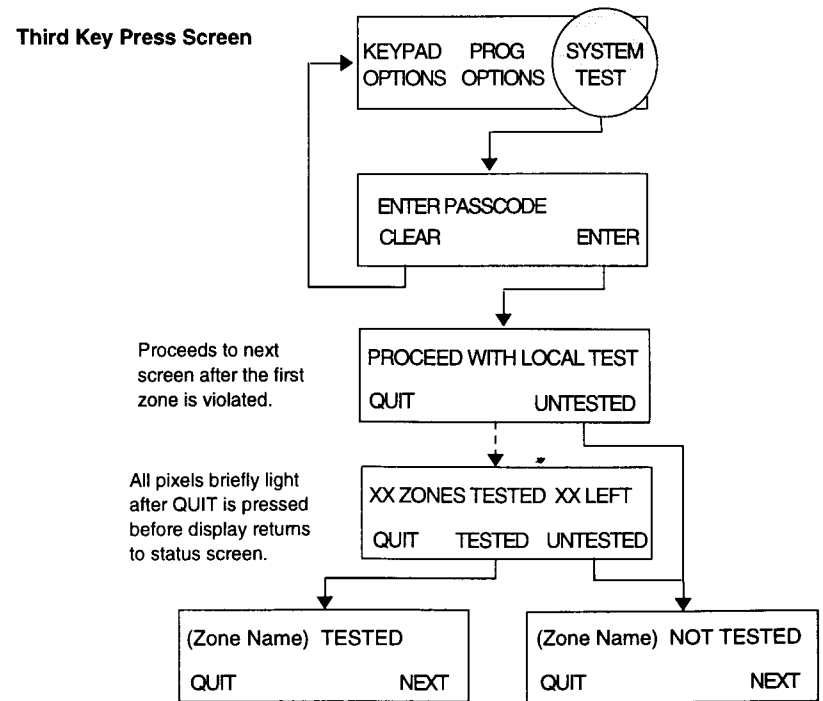

FIGURE 24 - SYSTEM TEST PROCEDURE

9.4 Functions Accessed by the Fourth Menu Press

SET CLOCK: Allows you to adjust the system's clock. Use the left and right arrow keys to move the cursor through the field. Use the numeric keypad to enter the digits for month, day, year, hour, minute and second. Press the QUIT to return the display to the status screen.

REMOTE CONNECT: This feature is used to manually connect the panel to your alarm company's remote programming computer over the telephone line. The alarm company will call on the telephone line connected to the control panel and request that you perform this. The control panel seizes the telephone line, disconnects you from the alarm company and makes your phone line go dead until completed.

COMM TEST: Allows you to test the communications link to your central station. If communications are established with the central station, the keypad displays COMM TEST SUCCESS.

Fourth Key Press Screen

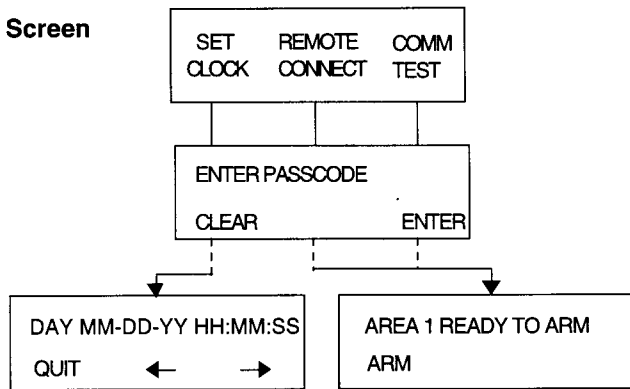

FIGURE 25 - FOURTH MENU PRESS FUNCTIONS

10.0

User Codes

10.1 Programming User Codes

Passcodes may be programmed at the user level. However, only a master user code (highest authority level) is allowed access to user programming mode.

1. Press the menu key three times to display Menu 3.

Third Key Press Screen

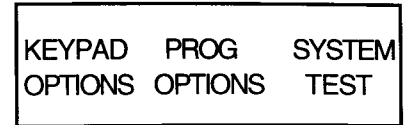

2. Press the PROG OPTIONS soft key. The display prompts you to ENTER PASSCODE.

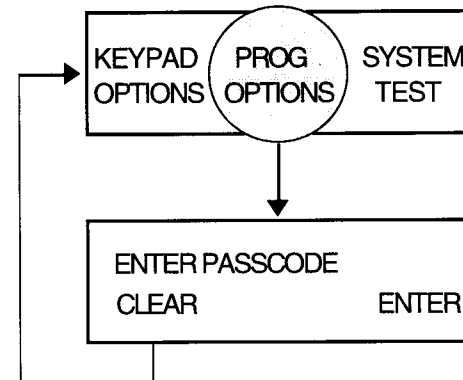

3. Enter your master user code and press ENTER. Press CLEAR if you accidentally enter a wrong digit. Once the proper code has been entered, the LCD screen displays the USER CODES, and SCHEDULE EVENTS menu options.

Note: Program Mode exits automatically after three minutes of no entries.



4. Press the USER CODES soft key. The screen displays the programmed information of the first user code. Only the user codes that share the same area assignment as the master code are displayed.

```

X.Y C:ZZZ "(User Name)"
PREV   NEXT   →

```

X = Area Number
Y = Authority Level
ZZZ = Passcode (Programmable)
User Name (Programmable)

5. To change a displayed code, simply enter the new digits. As you enter digits, the new code appears in the lower right corner of the display. The CLEAR and STORE prompts also appear.

Note: Duplicate codes are not permitted. If you enter a duplicate code, an error tone sounds and the system rejects the code.

```

X.Y C:ZZZ "(User Name)"
CLEAR  STORE  123..

```

New code appears while you key it in.

X = Area Number
Y = Authority Level
ZZZ = Passcode (Programmable)
User Name (Programmable)

6. Once you enter the correct digits, press the STORE soft key.
 7. To program a user name, press the right arrow soft key to place the cursor is between the " " marks.

```

X.Y C:ZZZ █
PREV   NEXT   →

```

Cursor in the User Name field.

Enter the letters of the user name using the numeric keypad to enter the characters. Press the "2" key once to display the letter "A." Press the "2" key twice to display the letter "B." See the following example for clarification of the character entry process.

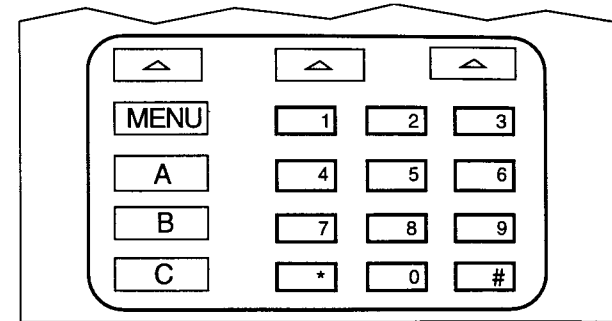

FIGURE 26 - NUMERIC KEYPAD

Key Characters:

1 = 0 1 2 3 4 5 6 7 8 9 ; : ? < => ? @	6 = M N O
2 = A B C	7 = P Q R S
3 = D E F	8 = T U V
4 = G H I	9 = W X Y Z
5 = J K L	0 = {space} ! " # \$ % & ' () * + , - . /

Example

To program the name "BEN":

- Press "2" twice ("B").
- Press the right arrow soft key once.
- Press "3" twice ("E").
- Press the right arrow soft key once.
- Press "6" twice ("N").
- Press the right arrow soft key once.
- Press the star key once to delete any extra characters or unused spaces to the right of the cursor.
- Press NEXT to advance to another user name.

Note: Pressing the number “#” key when the cursor is positioned in the User Name field changes the prompts at the bottom of the screen. The possible combinations are:

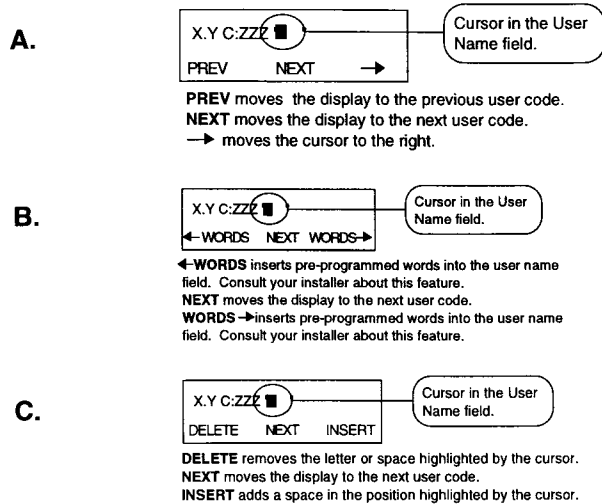

FIGURE 27 - USER NAME FIELD PROMPT

8. To advance to another user code, press NEXT.
9. When all codes and names have been added or changed, press the “*” key to return to the main system status display.

10.2 Deleting a User Code

To delete a user code, select the PROGRAM OPTIONS menu, enter the master code and select the USER CODES option. Select the appropriate code using the NEXT soft key, enter a 0 and select STORE.

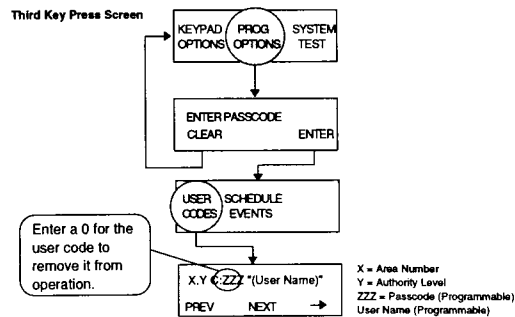

FIGURE 28 - DELETING A USER CODE PROCEDURE

10.3 Temporary Codes

The installer may designate an optional temporary code (Authority Level 4) in your system. This code, designed as a convenience feature, allows restricted access to the system. It is for use by people (baby-sitters, maintenance personnel, etc.) to whom you may wish to give limited, temporary access to the area protected by your security system.

This temporary code can be used to arm the control. However, the control can only be disarmed with this temporary code if the temporary code was used to arm the control in the first place. Once a regular user code is entered, the temporary code can no longer disarm the control.

The system allows the designation of more than one temporary code. These codes may have access to any combination of areas protected by the system. Consult your installer to determine the number and access designations of the temporary code(s). The temporary codes can be changed by the user, following the user code programming procedure outlined in Section 10.1 However, it is necessary to know the designation(s) of the code(s) before altering them is possible.

Example of a Temporary Code

You arrange for a neighbor to water your plants while you are on vacation. You give the neighbor the temporary code. When you leave for vacation, you arm the system using the temporary code instead of your regular code. Your neighbor can arm and disarm the system with the temporary code. If you arm the system with your regular code, the temporary code will not be able to disarm the system.

10.4 Using a Duress Code

Your installer may designate a duress code (Authority Level 9) in your system. This code should only be used when a user is being forced to manipulate the security system under duress — hence the name. When this code is used to arm or disarm, the system arms or disarms normally while sending a silent Panic Report to the central station. The central station notifies the proper authorities. **The installer must enable this code for it to operate.** The duress code can be changed by the user, following the user code programming procedure outlined in Section 10.1.

10.5 Access Control

Your system may be programmed with an access control feature. This feature is typically used as an entry control device. If this feature is enabled, it is engaged by entering a “0” and a user code followed by the ENTER soft key.

11.0

LED Keypad Operation

Your system may be equipped with an LED keypad. This type keypad allows you to operate the control in a very simple manner and is limited to **AWAY** level arming. The keypad can arm, disarm, view system status and perform access. This keypad may also be used in a system where limited or restricted access to specific areas of the protected premises is necessary.

To arm or disarm, enter the user authorization code and press the “#” key. If the system is not ready to arm due to a faulted zone, etc., an error tone sounds.

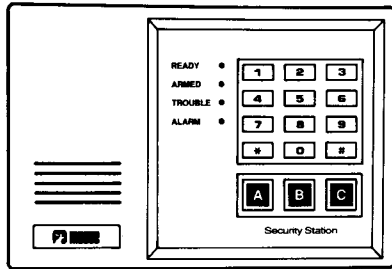

FIGURE 29 - LED KEYPAD

Indicator LEDs for the LED Keypad

STATUS LED: Is lit when all zones assigned to this keypad's area are in a secure state. This indicates the control is ready to be armed.

ARMED LED: Is lit when the burglary detection system assigned to this keypad is active and blinks when a burglar alarm occurs.

WARNING ! In the event of an alarm indication, be aware that an intrusion may have been detected and the premises may be occupied by unauthorized persons. Do not enter the premises without consulting the proper authorities.

ALARM LED: Is lit when any alarm other than a silent holdup alarm has been activated. Press “*” after silencing to reset.

TROUBLE LED: Is lit when the system detects a condition which warrants attention. Conditions of this type include, but are not limited to, AC Power Failure, Low Battery, Smoke Detection Circuit Trouble, and Supervisory Trouble on specially programmed devices. If this LED is lit and you cannot find and correct the cause, contact your alarm service representative.

12.0

Fire Detection

Your system may include fire detection, depending upon purchased options and the local regulations for your area. If so, please notify your local fire department that a fire alarm system has been installed. Fire systems require regular testing and maintenance. Common household dust buildup in smoke detectors can cause them to false alarm or fail in a time of need. Consult your alarm service representative for a scheduled maintenance program.

12.1 What To Do If The Fire Alarm Sounds

If the alarm was set off unintentionally, use the following procedures to silence and reset the system.

1. Press SILENCE.
2. Enter your user code to silence the control station sounder and the audible fire alarm. The system continues to report the condition to the central station.
3. Notify the alarm monitoring service or the proper authorities immediately.
4. If the alarm was activated due to a smoke detector, reset that detector by performing the SMOKE RESET function. See Section 9.2.

If the display indicates FIRE TROUBLE, a fire system wire may be broken making the fire system inoperable. Contact your alarm company's service representative.

12.2 Testing the Fire System

All devices in a Fire Alarm system should be tested monthly except as described in NFPA 72 chapter 7-3-2. Follow the instructions for SYSTEM TEST on page 25.

Appendix I

SCHEDULE EVENTS Definitions

Many options are accessible under the Schedule Events menu. From the third menu key press screen, select PROG OPTIONS. Enter your passcode as prompted. Select the SCHEDULE EVENTS option. From the AREA SCHEDULE screen, press SELECT to program this menu.

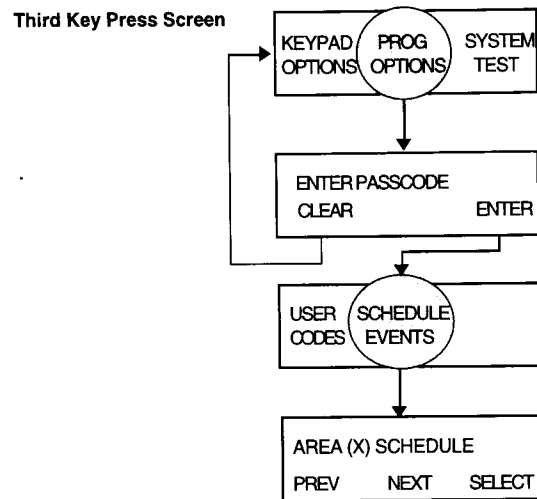

IMPORTANT: Automatic Arming and Disarming must not be programmed for the same days as Scheduled Manual Arming and Disarming.

AUTOMATIC ARMING AND DISARMING If Automatic Arming is enabled, the control produces a three-second audible warning signal at the appropriate control station(s) once every minute beginning ten minutes prior to the event. During this warning, the same control station displays a visual indication of the impending action and the amount of time remaining. This allows the user ample warning to exit or override the impending action as necessary. The time window is not used for this feature. Automatic Disarming occurs at the scheduled time with no warning. Auto Arming arms the area only in the AWAY mode.

Note: The time of an Auto Arm may be extended by one hour, as long as that extension does not go past midnight. Engage this function by selecting the EXTEND CLOSING option.

- 01 **A1 AUT ARM DAYS {SMTWTFS}** Automatic Arming: Select the day(s) of the week that the system automatically arms.
- 02 **A1 AUT DIS DAYS {SMTWTFS}** Automatic Disarming: Select the day(s) of the week that the system automatically disarms.

SCHEDULED MANUAL ARMING AND DISARMING These items are used to set up daily schedules for authorized opening and closings. The schedule indicates when the control expects an area to be armed and disarmed. A programmable time window allows reasonable variation before and after the time set for the user to arm and disarm the control. All arming or disarming that occurs within the programmed time window is logged automatically. If the arming or disarming occurs outside the time window, it may be reported to the central station which responds accordingly. There is no control station warning during this window. If the user fails to take the correct action, there is no local notification.

Note: The Late To Close deadline may be extended by one hour, as long as that extension does not go past midnight. Engage this function by selecting the EXTEND CLOSING option.

- 03 **A1 SCH CLS DAYS {SMTWTFS}** Schedule Closings: This entry allows designation of the day(s) of the week that the control "expects" to be disarmed by an authorized user. Select each day of the week by entering the corresponding number (1-7).
- 04 **A1 SCH OPN DAYS {SMTWTFS}** Schedule Openings: This entry allows the designation of the day(s) of the week that the control "expects" to be disarmed by an authorized user. Select each day of the week by entering the corresponding number (1-7).
- 05 **A1 TIME WINDOW: 0** ___ Time in minutes that the scheduled opening and closing may deviate +/- from the programmed timetable. Valid range = 0 - 255.

Note: The time window does not extend past midnight.

The following menu items establish a timetable for the events in items 1-4. If scheduled opening and closing events are enabled, the control "expects" the events to occur within the time parameters set (+/- the time window). If Automatic Arming/ Disarming is selected, the control arms/disarms the area on schedule (provided the system is able to arm).

- 06 **A1 CLOSE TIME SUN: 00:00/** ___ Programmed time for automatic arming or scheduled closing on Sunday. Enter all times in military (24-hour) time values.
- 07 **A1 CLOSE TIME MON: 00:00/** ___ Programmed time for automatic arming or scheduled closing on Monday.

- 08 **A1 CLOSE TIME TUE : 00:00/___** Programmed time for automatic arming or scheduled closing on Tuesday.
- 09 **A1 CLOSE TIME WED: 00:00/___** Programmed time for automatic arming or scheduled closing on Wednesday.
- 10 **A1 CLOSE TIME THU: 00:00/___** Programmed time for automatic arming or scheduled closing on Thursday.
- 11 **A1 CLOSE TIME FRI: 00:00/___** Programmed time for automatic arming or scheduled closing on Friday.
- 12 **A1 CLOSE TIME SAT: 00:00/___** Programmed time for automatic arming or scheduled closing on Saturday.
- 13 **A1 OPEN TIME SUN: 00:00/___** Programmed time for automatic disarming or scheduled opening on Sunday.
- 14 **A1 OPEN TIME MON: 00:00/___** Programmed time for automatic disarming or scheduled opening on Monday.
- 15 **A1 OPEN TIME TUE: 00:00/___** Programmed time for automatic disarming or scheduled opening on Tuesday.
- 16 **A1 OPEN TIME WED: 00:00/___** Programmed time for automatic disarming or scheduled opening on Wednesday.
- 17 **A1 OPEN TIME THU: 00:00/___** Programmed time for automatic disarming or scheduled opening on Thursday.
- 18 **A1 OPEN TIME FRI: 00:00/___** Programmed time for automatic disarming or scheduled opening on Friday.
- 19 **A1 OPEN TIME SAT: 00:00/___** Programmed time for automatic disarming or scheduled opening on Saturday.

Appendix II

Fire Protection Information

The following information is from the National Fire Protection Association (NFPA) Standard 72.

In Case of Fire

Leave immediately! Don't stop to pack or search for valuables. In heavy smoke, hold your breath and stay low. Crawl if necessary. The clearest air is usually at the floor. If you have to go through a closed door, carefully feel the door and door knob to see if undue heat is present. If relatively cool, brace your foot against the bottom of the door with your hip against the middle, and one hand against the top edge. Open slightly. If there is a rush of hot air, slam the door quickly and latch it. Unvented fire will build up considerable pressure. Instruct all family members or workers in this procedure.

Never stop inside a burning building to call the fire department. Instead, use a nearby phone to notify authorities of a fire.

Fire Prevention and Escape

The purpose of heat and smoke detectors is to detect a fire in its earliest stages and sound an alarm, giving occupants more time to exit the premises before smoke reaches a dangerous level. Instruct family members and workers to exit immediately when an alarm sounds.

Know Fire Hazards

No detection device can protect life in all situations. Therefore, safeguards should be taken to avoid potentially dangerous situations such as smoking in bed, cleaning with flammable liquids, or leaving children home alone.

The best fire protection is minimizing fire hazards through proper storage of materials and good housekeeping practices. Overloading of electrical outlets and careless use of combustible materials and electrical appliances are major causes of fire. Explosive and fast burning materials should be eliminated from the home and used with proper safeguards in the workplace.

Be Prepared

Establish a fire evacuation plan and perform fire drills regularly. Use them to ensure recognition of an alarm signal. For your protection, simulate different circumstances and have everyone react to the situation. Draw a floor plan and show two exits from each room. Establish one meeting place outside of the home or business and insist that all workers or family members meet there during an alarm. This will eliminate the tragedy of someone reentering a building to search for a missing person who is actually safe.

It is important that children be instructed carefully. They tend to hide in crisis situations. Train children in proper fire evacuation procedures.

Become familiar with the distinctive sounds of your fire and burglar alarm signals. Your installer can demonstrate the different audible signals emitted by your particular system.

☐ Smoke Detector Location

Smoke detectors should be installed in accordance with NFPA Standard 72. For residential applications, smoke detectors should be installed outside of each separate sleeping area, in the immediate vicinity of the bedrooms, and on each additional story of the family living unit, including basements and excluding crawl spaces and unfinished attics (see the illustration on the next page). In new construction, a smoke detector also should be installed in each sleeping room. For family living units with one or more split levels (i.e., adjacent levels with less than one full story separation between levels), a smoke detector required by the above suffices for an adjacent lower level, including basements. **EXCEPTION: Where an intervening door is between one level and the adjacent lower level, a smoke detector shall be installed on the lower level.** For commercial applications, smoke detectors should be installed in each separate working area, including hallways and storage areas.

Ceiling-mounted smoke alarms should be located in the center of the room or hall, not less than 4 inches from any wall. When the detector is mounted on a wall, the top of the detector should be 4 to 12 inches from the ceiling. Smoke detectors should not be mounted where the normal ambient temperatures are above 100°F (37.8°C) or below 40°F (4°C) or in front of air conditioners, heating registers, or other locations where normal air circulation will keep smoke from entering the detector.

Heat from a fire rises to the ceiling, spreads out across the ceiling surface and begins to bank down from the ceiling. Corners where the ceiling and walls meet form air spaces into which heat has difficulty penetrating. Usually, this 'dead' air space measures about 4 inches (10 cm) along the ceiling from the corner and 4 inches (10 cm) down the wall as shown in the illustration on the next page. Heat or smoke detectors should not be placed in this 'dead' air space.

Smoke Detector Locations

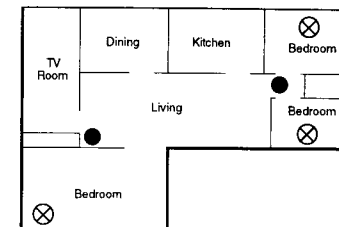
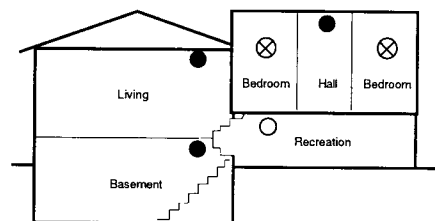
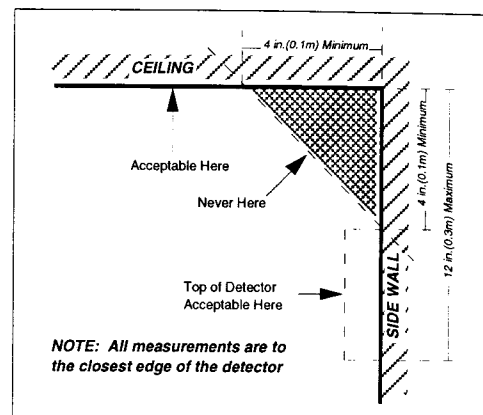

- Indicates required smoke detector
- Indicates smoke detector is optional if door is not provided between living and recreational rooms.
- ⊗ Indicates smoke detector required in new construction.

In family living units with more than one sleeping area, a smoke detector should be provided to protect each sleeping area in addition to the detectors required in bedrooms.

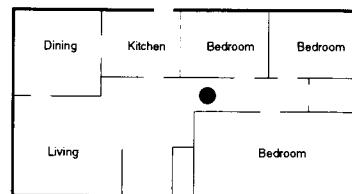

A smoke detector should be located between the sleeping area and the rest of the family living unit (existing construction).

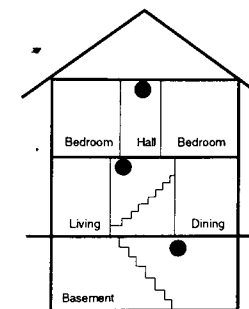

A smoke detector should be located on each story.

Glossary

- ACCESS:** A system feature that allows one or more keypads to be used as access control devices.
- AC POWER:** Alternating current supplied from the plugged-in transformer.
- AREA:** The region or regions of the premises protected by the security system.
- ARM:** To turn the intrusion detection system on.
- AUTHORITY LEVEL:** A designation assigned to each user code that determines which specific functions can be accessed by that user. Authority levels range from Level 1 to Level 15. Level 1 is permitted to operate the access feature only. Level 15 can perform all system functions.
- AUXILIARY PANIC KEYS:** Programmed to activate different types of distress signals (Burglar, Fire, Holdup, Medical). Always work, regardless of whether or not the main system is armed.
- BYPASS:** To remove a zone from service by causing the system to ignore a zone. Automatically removed when the system is disarmed.
- CENTRAL STATION:** A facility which monitors your security system and contacts police, fire department, etc., in response to alarms from that system.
- CONTROL PANEL:** The main system electronics housed in a metal enclosure
- CONTROL STATION:** Same as LCD Keypad.
- DISARM:** To turn the intrusion detection system off.
- ENTRY DELAY:** A programmed "pause" that occurs before the system activates an alarm after certain entry zones are violated. Designed to give the user an opportunity to enter the premises and disarm the system without causing an alarm.
- EXIT DELAY:** A programmed period of time immediately after the system is armed during which the system "expects" a designated entry zone to be violated. Designed to give the user an opportunity to exit the premises without causing an alarm after arming the system.
- FORCE ARM:** To activate the intrusion detection system in spite of the presence of faulted zones. If a faulted zone is secured during the armed period, that zone is automatically armed by the system.
- INTERIOR:** Zones consisting of motion detectors or interior door contacts designed to detect intruders within the building.
- LED KEYPAD:** Remote arming station with light-emitting diode display. Allows limited access to system functions.
- LCD KEYPAD:** An arming/ programming station with a 2 x 24 character liquid crystal display. Controls any or all system functions, depending on programming.
- MASTER USER CODE:** A code that allows access to the programming mode of operation.
- PASSCODE:** Same as a user code.
- PERIMETER:** Zones consisting of exterior door and window contacts.
- PROGRAM:** To set the specific features of the control station or control panel.
- PROMPT:** A request by the control station for input from the user.
- TWENTY-FOUR-HOUR ZONE:** A zone that is permanently active 24 hours a day (such as a fire zone).
- USER CODE:** Sets of numbers with varying authority levels which allow users to perform operations of the system.
- ZONE:** A specific item of protection that can be individually controlled, such as a contacted door or window, smoke detector or sensor.

Index

A

- AC POWER FAILURE 15
- adjust beeps 23
- adjust lamp 23
- Alarm 14
- Alarm LED 32
- arm 31
- ARMED 4
- ARMED INST 4
- Armed Led 32
- ARMED NITE 5
- ARMED NITE INST 5
- ARMED STAY 4
- ARMED STAY INST 5
- Arming 4
- ARMING LEVEL 4
- Automatic Arming 34
- Automatic Disarming 34
- Auxiliary Panic Keys 3, 17
- Auxiliary Zon 17
- Auxiliary Zones 17
- AWAY 4

B

- BLOWN FUSE 15
- Burglar Alarm 17
- Bypassing 8, 9, 19
- bypassing burglary zones 19

C

- Clear/Quit Key 3
- COMM TEST 26
- Communication Failure 15
- communications link 26
- customer entry notification 20

D

- disarm 31
- Disarming 4
- DISP 20
- display 6
- Duress Code 31

E

- emergency panic 17, 32
- Enable Chime 20
- Enter Key 3
- Event History 21
- Event History 20
- EXTEND CLOSING 22, 34, 35

F

- Fire Alarm 17, 33
- Fire CIRCUIT trouble 15
- Fire Detection 33
- Fire Hazards 37
- Fire Initiating Circuits 25
- Fire Panic Key 33
- Fire Prevention 37
- Fire Protection 37
- fire system audibles 33
- fire system test 33
- FIRE TROUBLE 33
- First Menu Press 18, 19
- Force Arming 6, 7
- Fourth Menu Press 26

H

- Hold-up Alarm 17, 19
- hold-up alarm 17
- Hold-up Alarms 19

I

- Indicator LEDs 32
- interior zones 4
- ire system audibles 33

K

- KEYPAD OPTIONS 23

L

- Late To Close 35
- LCD 3
- LCD Display 3
- LED Keypad Operation 32
- Local Test 25
- LOW BATTERY 15

M

- Main Menu Screens 18
- master user code 27
- Medical Alarm 17
- Memory Error 15
- Menu 3 27
- Menu Features 18
- Menu Key 3, 18
- MISSING KEYPAD 15

N

- National Fire Protection Association 37
- NIGHT 4
- Normal System Arming 5

Normal System Disarming 5
not ready 6
Numeric Keypad 29

P

panic. *See* emergency panic
Panic Keys 17
Passcodes 27
perimeter zones 4
power light 3
pre-alarm delay 4
PRINT 20
PROG OPTIONS 24, 27
Program Mode 27
Programming User Codes 27

Q

Quick Arming 10
Quick Arming Level Change 12
Quick Commands 10
Quick Disarming 11
Quick Force Arming 13

R

ready 4
READY TO ARM 4, 5
REMOTE CONNECT 26
Reset Alarm 19
residential door annunciation
door annunciation
door annunciation, residential 20

S

Schedule Closing 35
SCHEDULE EVENTS 24, 34
Schedule Opening 35
Scheduled Manual Arming 35
Scheduled Manual Disarming 35
Second Menu Press 20
SET CLOCK 26
SILENCE 15, 16
Silencing an Alarm 14
Smoke Detector 38, 39
smoke detector 33
Smoke Detector Location 38
smoke detectors 22, 37, 38
SMOKE RESET 22
Soft Feature Keys 3
Status Indicator 3
Status Led 32
STAY 4
System Not Ready 6
system ready 4
System Reference Guide 17, 33
SYSTEM TEST 25

T

Third Menu Press 23
time 14
Trouble Condition 16
Trouble Conditions 15
Trouble LED 32

U

USER CODES 24
User Codes 27

V

View Status 19
viewing angle 23

NOTES

NOTES

System Reference Guide

Emergency Telephone Numbers

Police _____ Fire _____

Neighbor _____ Doctor _____

Central Station _____ Service Rep. _____

Delay Times

_____ Seconds of **exit delay time** for Zone(s) _____

_____ Seconds of **entry time (Delay 1)** for Zone(s) _____

_____ Seconds of **entry time (Delay 2)** for Zone(s) _____

Central Station Information

Subscriber Number _____

Features Enabled

- | | |
|---|--|
| <input type="checkbox"/> Intrusion | <input type="checkbox"/> Household Fire |
| <input type="checkbox"/> Auxiliary Alarm | <input type="checkbox"/> Hold-up |
| <input type="checkbox"/> Force Arming Enabled | <input type="checkbox"/> Bypassing Enabled |
| | <input type="checkbox"/> Listen-In Enabled |

■ Panic Key (Key "A") Designation: _____

■ Panic Key (Key "B") Designation: _____

■ Panic Key (Key "C") Designation: _____

■ Passcode Attempts Before Keypad Lockout: _____

Note: The lockout is a temporary measure that affects only the keypad in use for the passcode attempts.

The Auto - Arm feature must not be enabled on UL Listed systems.