

Fire Alarm Control Panel MS-9600/MS-9600E

IMPORTANT! The SLC Manual Document #51309 must be referenced in addition to this manual when installing or servicing the Fire Alarm Control Panel.

Fire Alarm System Limitations

An automatic fire alarm system—typically made up of smoke detectors, heat detectors, manual pull stations, audible warning devices, and a fire alarm control with remote notification capability—can provide early warning of a developing fire. Such a system, however, does not assure protection against property damage or loss of life resulting from a fire.

The Manufacturer recommends that smoke and/or heat detectors be located throughout a protected premise following the recommendations of the current edition of the National Fire Protection Association Standard 72 (NFPA 72), manufacturer's recommendations, State and local codes, and the recommendations contained in the Guide for Proper Use of System Smoke Detectors, which is made available at no charge to all installing dealers. A study by the Federal Emergency Management Agency (an agency of the United States government) indicated that smoke detectors may not go off in as many as 35% of all fires. While fire alarm systems are designed to provide early warning against fire, they do not guarantee warning or protection against fire. A fire alarm system may not provide timely or adequate warning, or simply may not function, for a variety of reasons:

Smoke detectors may not sense fire where smoke cannot reach the detectors such as in chimneys, in or behind walls, on roofs, or on the other side of closed doors. Smoke detectors also may not sense a fire on another level or floor of a building. A second-floor detector, for example, may not sense a first-floor or basement fire.

Particles of combustion or "smoke" from a developing fire may not reach the sensing chambers of smoke detectors because:

- Barriers such as closed or partially closed doors, walls, or chimneys may inhibit particle or smoke flow.
- Smoke particles may become "cold," stratify, and not reach the ceiling or upper walls where detectors are located.
- Smoke particles may be blown away from detectors by air outlets.
- Smoke particles may be drawn into air returns before reaching the detector.

The amount of "smoke" present may be insufficient to alarm smoke detectors. Smoke detectors are designed to alarm at various levels of smoke density. If such density levels are not created by a developing fire at the location of detectors, the detectors will not go into alarm.

Smoke detectors, even when working properly, have sensing limitations. Detectors that have photoelectronic sensing chambers tend to detect smoldering fires better than flaming fires, which have little visible smoke. Detectors that have ionizing-type sensing chambers tend to detect fast-flaming fires better than smoldering fires. Because fires develop in different ways and are often unpredictable in their growth, neither type of detector is necessarily best and a given type of detector may not provide adequate warning of a fire.

Smoke detectors cannot be expected to provide adequate warning of fires caused by arson, children playing with matches (especially in bedrooms), smoking in bed, and violent explosions (caused by escaping gas, improper storage of flammable materials, etc.).

While a fire alarm system may lower insurance rates, it is not a substitute for fire insurance!

Heat detectors do not sense particles of combustion and alarm only when heat on their sensors increases at a predetermined rate or reaches a predetermined level. Rate-of-rise heat detectors may be subject to reduced sensitivity over time. For this reason, the rate-of-rise feature of each detector should be tested at least once per year by a qualified fire protection specialist. *Heat detectors are designed to protect property, not life.*

IMPORTANT! Smoke detectors must be installed in the same room as the control panel and in rooms used by the system for the connection of alarm transmission wiring, communications, signaling, and/or power. If detectors are not so located, a developing fire may damage the alarm system, crippling its ability to report a fire.

Audible warning devices such as bells may not alert people if these devices are located on the other side of closed or partly open doors or are located on another floor of a building. Any warning device may fail to alert people with a disability or those who have recently consumed drugs, alcohol or medication. Please note that:

- Strobes can, under certain circumstances, cause seizures in people with conditions such as epilepsy.
- Studies have shown that certain people, even when they hear a fire alarm signal, do not respond or comprehend the meaning of the signal. It is the property owner's responsibility to conduct fire drills and other training exercise to make people aware of fire alarm signals and instruct them on the proper reaction to alarm signals.
- In rare instances, the sounding of a warning device can cause temporary or permanent hearing loss.

A fire alarm system will not operate without any electrical power. If AC power fails, the system will operate from standby batteries only for a specified time and only if the batteries have been properly maintained and replaced regularly.

Equipment used in the system may not be technically compatible with the control. It is essential to use only equipment listed for service with your control panel.

Telephone lines needed to transmit alarm signals from a premise to a central monitoring station may be out of service or temporarily disabled. For added protection against telephone line failure, backup radio transmission systems are recommended.

The most common cause of fire alarm malfunction is inadequate maintenance. To keep the entire fire alarm system in excellent working order, ongoing maintenance is required per the manufacturer's recommendations, and UL and NFPA standards. At a minimum, the requirements of Chapter 7 of NFPA 72 shall be followed. Environments with large amounts of dust, dirt or high air velocity require more frequent maintenance. A maintenance agreement should be arranged through the local manufacturer's representative. Maintenance should be scheduled monthly or as required by National and/or local fire codes and should be performed by authorized professional fire alarm installers only. Adequate written records of all inspections should be kept.

Installation Precautions

WARNING - Several different sources of power can be connected to the fire alarm control panel. Disconnect all sources of power before servicing. Control unit and associated equipment may be damaged by removing and/or inserting cards, modules, or interconnecting cables while the unit is energized. Do not attempt to install, service, or operate this unit until this manual is read and understood.

CAUTION - *System Reacceptance Test after Software Changes.* To ensure proper system operation, this product must be tested in accordance with NFPA 72 Chapter 7 after any programming operation or change in site-specific software. Reacceptance testing is required after any change, addition or deletion of system components, or after any modification, repair or adjustment to system hardware or wiring.

All components, circuits, system operations, or software functions known to be affected by a change must be 100% tested. In addition, to ensure that other operations are not inadvertently affected, at least 10% of initiating devices that are not directly affected by the change, up to a maximum of 50 devices, must also be tested and proper system operation verified.

This system meets NFPA requirements for operation at 0-49° C/32-120° F and at a relative humidity of 85% RH (non-condensing) at 30° C/86° F. However, the useful life of the system's standby batteries and the electronic components may be adversely affected by extreme temperature ranges and humidity. Therefore, it is recommended that this system and all peripherals be installed in an environment with a nominal room temperature of 15-27° C/60-80° F.

Verify that wire sizes are adequate for all initiating and indicating device loops. Most devices cannot tolerate more than a 10% I.R. drop from the specified device voltage.

Adherence to the following will aid in problem-free installation with long-term reliability:

Like all solid state electronic devices, this system may operate erratically or can be damaged when subjected to lightning-induced transients. Although no system is completely immune from lightning transients and interferences, proper grounding will reduce susceptibility. *Overhead or outside aerial wiring is not recommended, due to an increased susceptibility to nearby lightning strikes.* Consult with the Technical Services Department if any problems are anticipated or encountered.

Disconnect AC power and batteries prior to removing or inserting circuit boards. Failure to do so can damage circuits.

Remove all electronic assemblies prior to any drilling, filing, reaming, or punching of the enclosure. When possible, make all cable entries from the sides or rear. Before making modifications, verify that they will not interfere with battery, transformer, and printed circuit board location.

Do not tighten screw terminals more than 9 in-lbs. Over-tightening may damage threads, resulting in reduced terminal contact pressure and difficulty with screw terminal removal.

Though designed to last many years, system components can fail at any time. This system contains static-sensitive components. Always ground yourself with a proper wrist strap before handling any circuits so that static charges are removed from the body. Use static-suppressive packaging to protect electronic assemblies removed from the unit.

Follow the instructions in the installation, operating, and programming manuals. These instructions must be followed to avoid damage to the control panel and associated equipment. FACP operation and reliability depend upon proper installation by authorized personnel.

FCC Warning

WARNING: This equipment generates, uses, and can radiate radio frequency energy and if not installed and used in accordance with the instruction manual, may cause interference to radio communications. It has been tested and found to comply with the limits for class A computing device pursuant to Subpart B of Part 15 of FCC Rules, which is designed to provide reasonable protection against such interference when operated in a commercial environment. Operation of this equipment in a residential area is likely to cause interference, in which case the user will be required to correct the interference at his own expense.

Canadian Requirements

This digital apparatus does not exceed the Class A limits for radiation noise emissions from digital apparatus set out in the Radio Interference Regulations of the Canadian Department of Communications.

Le présent appareil numérique n'émet pas de bruits radioélectriques dépassant les limites applicables aux appareils numériques de la classe A prescrites dans le Règlement sur le brouillage radioélectrique édicté par le ministère des Communications du Canada.

Notes

Table of Contents

SECTION 1: Product Description	12
1.1: Inventory	12
1.2: Features and Options	12
1.3: Specifications	14
1.3.1: Current Availability.....	15
1.4: Controls and Indicators	16
1.5: Circuits	17
1.6: Components.....	17
1.6.1: Intelligent Addressable Detectors: Newer Series.....	18
1.6.2: Intelligent Addressable Modules: Newer Series	19
1.6.3: 300 Series Intelligent Addressable Devices.....	20
1.6.4: Addressable Device Accessories.....	20
1.7: Optional Modules.....	20
1.8: Accessories.....	21
1.8.1: PK-9600 Programming Utility.....	21
1.8.2: Dress Panel.....	21
1.8.3: Battery Box	21
1.8.4: CHG-120F Battery Charger	22
1.8.5: Annunciators	22
1.9: Getting Started.....	23
SECTION 2: Installation	24
2.1: Mounting	24
2.2: Power.....	27
2.2.1: AC Power and Earth Ground Connection.....	27
2.2.2: Battery Power.....	27
2.2.3: DC Power Output Connection	27
2.3: Relays	28
2.4: Notification Appliance Circuits	28
2.5: UL Power-limited Wiring Requirements	29
2.6: Optional Modules and Devices	30
2.6.1: 4XTMF Transmitter Module Installation.....	31
2.6.2: Auxiliary Trouble Input (J16 & J17).....	32
2.6.3: SLC-2 Expander Module	33
2.6.4: Printer/PC.....	34
2.6.5: Digital Communicator and Annunciators	35
2.6.5.1 UDACT-F Digital Alarm Communicator/Transmitter	35
2.6.5.2 ACM-8RF Relay Control Module	35
2.6.5.3 BRKT-9600 Universal Bracket Installation	35
2.6.5.4 ACM and AFM Series Annunciators	37
SECTION 3: Programming	38
3.1: Programming Data Entry	38
3.2: User Programming	39
3.3: Initial Power-up.....	40
3.4: Programming Screens Description.....	40
3.5: Programming and Passwords	40
3.6: Master Programming Level.....	42
3.6.1: Point Program	43
3.6.1.1 Detector Programming	43
3.6.1.1.1 Add Detector	43
3.6.1.1.2 Delete Detector	44
3.6.1.1.3 Edit Detector	44
3.6.1.2 Module Programming	53

Table of Contents

3.6.1.2.1 Add Module	53
3.6.1.2.2 Delete Module	54
3.6.1.2.3 Edit Module Screen for Monitor Module	55
3.6.1.2.4 Edit Module Screen for Control Modules	63
3.6.2: Zone Setup.....	70
3.6.2.1 Enable	70
3.6.2.2 Disable	71
3.6.2.3 Zone 97, 98 and 99	71
3.6.2.4 Zones Installed	72
3.6.2.5 Zones Enabled	72
3.6.2.6 Zones Disabled	72
3.6.2.7 Zone Type	73
3.6.3: Loop Setup	74
3.6.3.1 Style	74
3.6.3.2 Loop Protocol	74
3.6.4: System Setup	75
3.6.4.1 Trouble Reminder	75
3.6.4.2 Banner	76
3.6.4.3 Time-Date	77
3.6.4.3.1 Time	77
3.6.4.3.2 Date	78
3.6.4.3.3 Clock Format	78
3.6.4.3.4 Daylight Savings Time	78
3.6.4.4 Timers	79
3.6.4.4.1 PAS (Positive Alarm Sequence) Delay	79
3.6.4.4.2 Pre-signal Delay	80
3.6.4.4.3 Waterflow Delay	80
3.6.4.4.4 AC Loss Delay	81
3.6.4.5 NAC (Notification Appliance Circuit)	81
3.6.4.5.1 Enabled	82
3.6.4.5.2 Type	83
3.6.4.5.3 Silenceable	83
3.6.4.5.4 Auto Silence	84
3.6.4.5.5 Coding	84
3.6.4.5.6 Zone	85
3.6.4.5.7 Silence Inhibited	85
3.6.4.5.8 Synced Type	85
3.6.4.6 Relays	86
3.6.5: Autoprogram	87
3.6.6: Verify Loops.....	88
3.6.7: History	88
3.6.7.1 View Events	89
3.6.7.2 Erase History	89
3.6.8: Walktest.....	90
3.6.9: Option Modules.....	91
3.6.9.1 Annunciators/UDACT	91
3.6.9.2 Printer/PC	92
3.6.10: Password Change	93
3.6.11: Clear Program.....	94
3.6.12: Program Check.....	95
3.7: Maintenance Programming Level	97
3.7.1: Disable Point	98
3.7.2: History	99
3.7.3: Program Check.....	100
3.7.4: Walktest.....	101

Table of Contents

3.7.5: System 101

3.7.6: Zone Setup 103

SECTION 4: Operating Instructions 105

4.1: Panel Control Buttons 105

4.1.1: Acknowledge/Step 105

4.1.2: Alarm Silence 105

4.1.3: Drill/Hold 2 Sec 105

4.1.4: Reset 105

4.2: LED Indicators 106

4.3: Normal Operation 107

4.4: Trouble Operation 107

4.5: Alarm Operation 109

4.6: Supervisory Operation 110

4.7: Process Monitor Operation 111

4.8: Hazard Condition Operation 111

4.9: Medical Alert Condition Operation 111

4.10: NAC Operation 111

4.11: Programmed Zone Operation 112

4.12: Disable/Enable Operation 112

4.13: Waterflow Circuits Operation 112

4.14: Detector Functions 112

4.15: Time Functions: Real-Time Clock 112

4.16: Synchronized NAC Operation 113

4.17: Coded Operation 113

4.18: Presignal 113

4.19: Positive Alarm Sequence 114

4.20: Special System Timers 115

4.20.1: Silence Inhibit Timer 115

4.20.2: Autosilence Timer 115

4.20.3: Trouble Reminder 115

4.20.4: Waterflow Retard Timer 115

4.20.5: Alarm Verification (None or Two Minutes) 116

4.21: Walktest 116

4.22: Read Status 117

4.22.1: System Point 118

4.22.2: Zones 119

4.22.3: Power 120

4.22.4: Trouble Reminder 120

4.22.5: Timers 121

4.22.6: NAC 121

4.22.7: Relays 122

4.22.8: Program Check 122

4.22.9: History 122

4.22.10: Annunciators 123

4.22.11: Printer/PC 123

4.22.12: Print 124

4.22.13: Time-Date 126

SECTION 5: Power Supply Calculations 127

5.1: Overview 127

5.2: Calculating the AC Branch Circuit 127

5.3: Calculating the System Current Draw 128

5.3.1: Overview 128

5.3.2: How to Use Table 5.3 on page 129 to Calculate System Current Draw 128

5.4: Calculating the Battery Size 130

Table of Contents

5.4.1: NFPA Battery Requirements 130
5.4.2: Selecting and Locating Batteries..... 130
APPENDIX A: Software Zones131
 A.1: Correlations 131
APPENDIX B: Default Programming139
APPENDIX C: Wire Requirements140

It is imperative that the installer understand the requirements of the Authority Having Jurisdiction (AHJ) and be familiar with the standards set forth by the following regulatory agencies:

- Underwriters Laboratories Standards
- NFPA 72 National Fire Alarm Code
- CAN/ULC - S527M Standard for Control Units for Fire Alarm Systems

Before proceeding, the installer should be familiar with the following documents.



NFPA Standards

NFPA 72 National Fire Alarm Code
NFPA 70 National Electrical Code



Underwriters Laboratories Documents:

UL 38 Manually Actuated Signaling Boxes
UL 217 Smoke Detectors, Single and Multiple Station
UL 228 Door Closers-Holders for Fire Protective Signaling Systems
UL 268 Smoke Detectors for Fire Protective Signaling Systems
UL 268A Smoke Detectors for Duct Applications
UL 346 Waterflow Indicators for Fire Protective Signaling Systems
UL 464 Audible Signaling Appliances
UL 521 Heat Detectors for Fire Protective Signaling Systems
UL 864 Standard for Control Units for Fire Protective Signaling Systems
UL 1481 Power Supplies for Fire Protective Signaling Systems
UL 1610 Central Station Burglar Alarm Units
UL 1638 Visual Signaling Appliances
UL 1971 Signaling Devices for Hearing Impaired



CAN/ULC - S524M Standard for Installation of Fire Alarm Systems
CAN/ULC S527M Standard for Control Units for Fire Alarm Systems
Note: MS-9600E is not ULC listed for Canadian applications

Other:

EIA-232E Serial Interface Standard
EIA-485 Serial Interface Standard
NEC Article 250 Grounding
NEC Article 300 Wiring Methods
NEC Article 760 Fire Protective Signaling Systems
Applicable Local and State Building Codes
Requirements of the Local Authority Having Jurisdiction (LAHJ)

Fire-Lite Documents:

Fire-Lite Device Compatibility	Document #15384
SLC Wiring Manual	Document #51309
AFM-16ATF & AFM-32AF	Document #15970
AFM-16AF Annunciator	Document #15210
ACS Series Annunciators	Document #51480
UDACT-F Communicator/Transmitter	Document #50049
CHG-120F Battery Charger	Document #50888
LDM Series Lamp Driver Modules	Document #50055
LCD-80F Remote Fire Annunciator	Document #51338
ACM-8RF Relay Control Module	Document #50362

FIRE-LITE® ALARMS

MS-9600 Basic System Connections

Notification Appliance Circuits
 NAC #1 NAC #2
 Style Y (shown) Style Y or
 or Style Z Style Z (shown)
 3.0 amps max. 3.0 amps max.
 ELR 4.7K, ½W

DC Power Outputs (24 VDC)
 Supervise with a power supervision relay A77-718B

Nonresettable Power #2 - 24 VDC filtered, power-limited (3.00 amps maximum) Supervision required. Suitable for powering annunciators.

Nonresettable Power #1 - 24 VDC filtered, power-limited (3.00 amps maximum) Supervision required. Suitable for powering annunciators.

Resettable Power - 24 VDC filtered, power-limited (3.00 amps maximum) to smoke detectors (IDC). Supervision required.

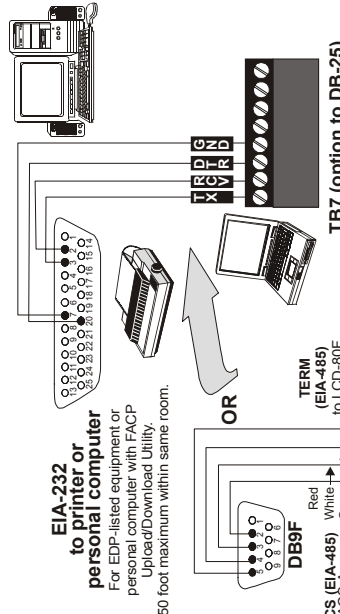

2 Programmable Relays & 1 Fixed Trouble Relay

Contact Ratings:
 2.0 amps @ 30 VDC (resistive)
 0.5 amps @ 30 VAC (resistive)
 Contacts shown below in normal condition (AC power with no alarm, trouble or supervisory activity).
 A Fail Safe Trouble relay switches to the NO position during trouble conditions and under loss of all power.

Alarm* Trouble Supervisory
 NO/NC NC/NO NC/G

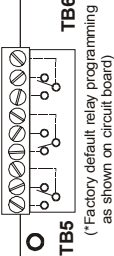

(*Factory default relay programming as shown on circuit board)

Cut this jumper to disable the FACP battery charger when using external charger.



CUT TO DISABLE BATTERY CHARGER



CUT TO MONITOR 4XTMF



CUT TO SUPERVISE THE 4XTMF MODULE WHEN INSTALLED (SEE JP10 & JP11)



4XTMF OPT BD
 Connectors for 4XTMF option module



To disable ground fault detection, remove jumper/shunt from JP2



DISABLE GND FLT



Auxiliary Trouble Inputs #1 #2



J17 J16



TB1 LCD DISPLAY



TB2 BATTERY- +BATTERY-

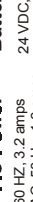

CB1 HOT NEUT EARTH

Battery
 24 VDC, 25 Amp Hour maximum

AC Power
 120 VAC, 60 HZ, 3.2 amps
 220/240 VAC, 50 HZ, 1.6 amps

CAUTION! HIGH VOLTAGE

9600ayE.cdr

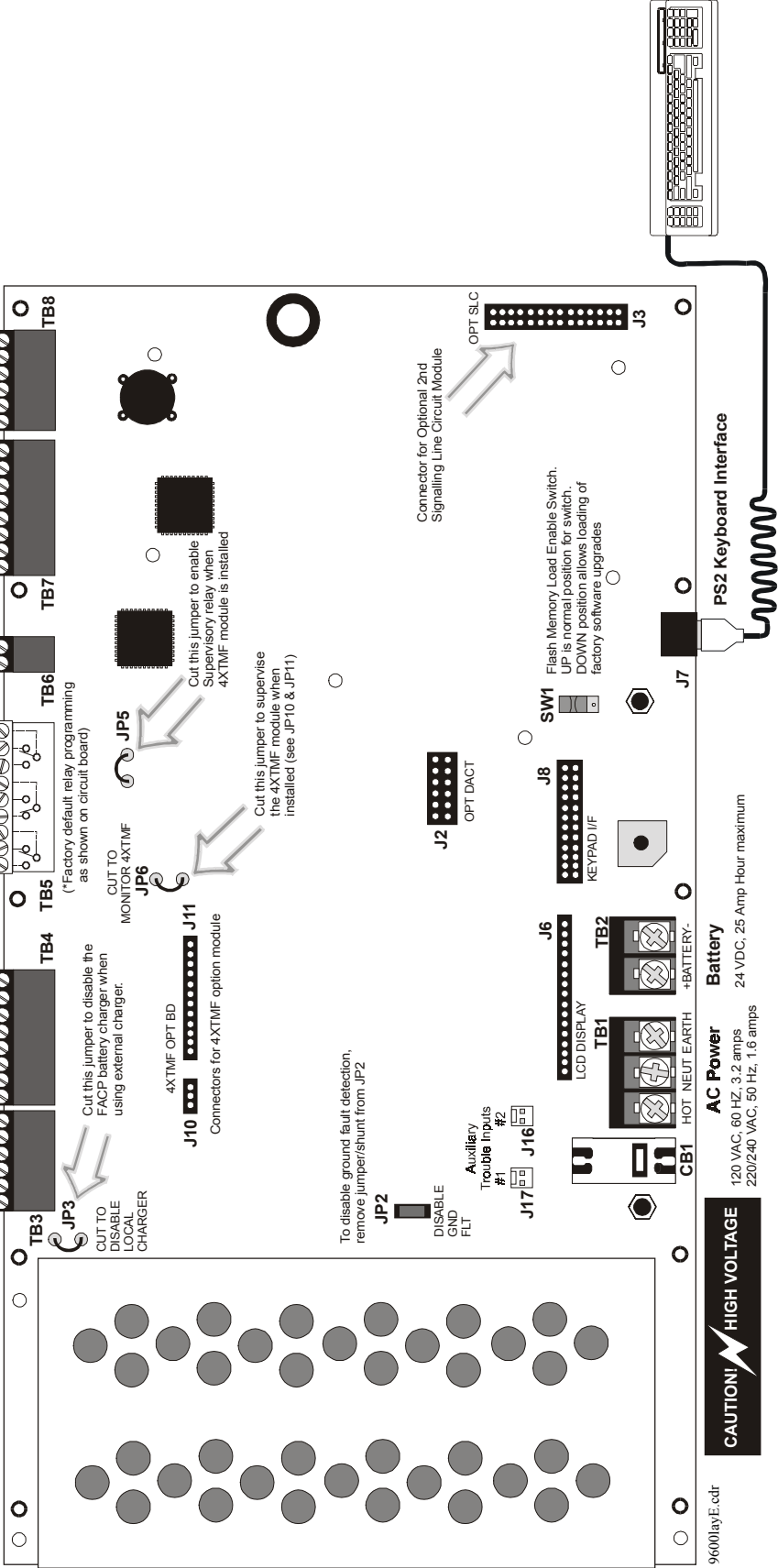

Connector for Optional 2nd Signalling Line Circuit Module

OPT SLC

J3

J7

PS2 Keyboard Interface

J8

KEYPAD I/F

J6

TB2

BATTERY-

AC Power

120 VAC, 60 HZ, 3.2 amps

220/240 VAC, 50 HZ, 1.6 amps

CAUTION! HIGH VOLTAGE

9600ayE.cdr

Peripheral Devices and Their Documents:

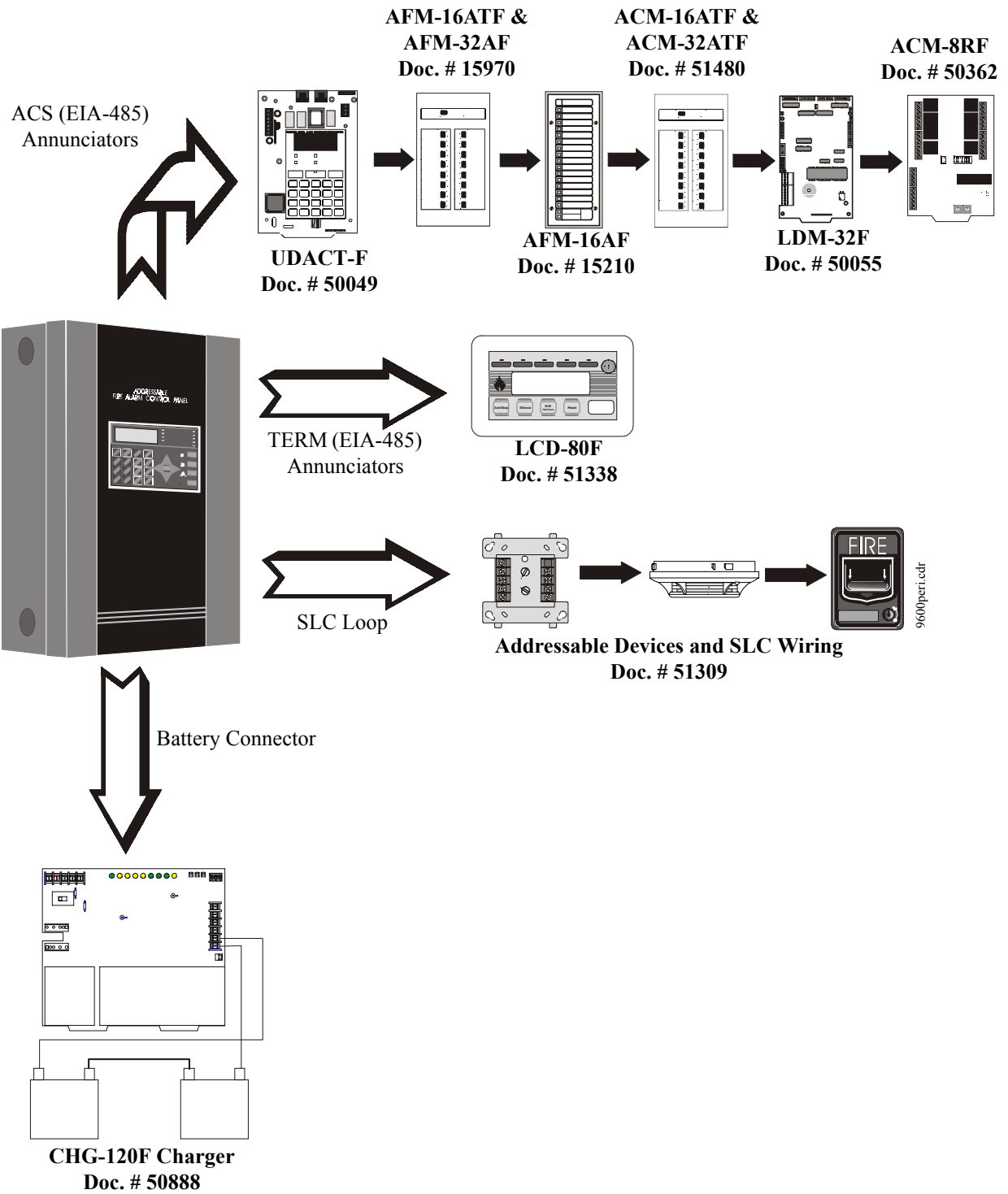

SECTION 1

Product Description

The Fire•Lite MS-9600 is a compact, cost effective, intelligent addressable FACP (Fire Alarm Control Panel) with an extensive list of powerful features. The combination of Fire•Lite's newer series devices and legacy 300 Series devices, along with the MS-9600 FACP, offer the latest in fire protection technology. The power supply and all electronics are contained on a single circuit board housed in a metal cabinet, providing a complete fire control system for most applications. Optional modules, which plug into the main circuit board, are available for special functions. Available accessories include LED, graphic and LCD annunciators, reverse polarity/city box transmitter, digital alarm communicator/transmitter, SLC expansion module, local and remote upload/download software and remote power expansion. The MS-9600E offers the same features as the MS-9600 but allows connection to 220/240 VAC input.

Note: Unless otherwise specified, the term MS-9600 is used in this manual to refer to both the MS-9600 and the MS-9600E FACPs.

1.1 Inventory

When the MS-9600 shipment is received, check to make certain that all parts have been included in the shipment. The MS-9600 shipment should consist of one of each of the following:

- ✓ main circuit board with display
- ✓ backbox with door
- ✓ plastic bag containing screws, cables, key, etc.
- ✓ manual

1.2 Features and Options

- Single standard addressable SLC loop which meets NFPA Style 4, 6 and 7 requirements
- Optional module for adding a second SLC loop which meets NFPA Style 4, 6 and 7 requirements
- 318 addressable device capacity for each SLC loop (159 detectors and 159 control/monitor modules)
- 99 software zones
- Two onboard NACs (Notification Appliance Circuits) with additional NAC capability using control modules
- 6.0 amps total power for NACs and 24 VDC auxiliary power outputs
- 7.2 amps total system power (includes battery charger)
- Two programmable relay outputs and one fixed trouble relay
- EIA-232 Printer/PC interface (variable baud rate)
- 80-character LCD display (backlit)
- Real-time clock/calendar with daylight savings time control
- History file with 1,000 event capacity
- Advanced fire technology features:
 - ✓ Automatic drift compensation
 - ✓ Maintenance alert
 - ✓ Detector sensitivity test capability (NFPA 72 compliant)
 - ✓ Automatic device type-code verification
 - ✓ Point trouble identification
- Waterflow selection per module point

- Alarm verification selection per detector point
- Walktest, silent or audible
- PAS (Positive Alarm Sequence) and Pre-signal per point (NFPA 72 compliant)
- Annunciators:
 - ✓ ACM Series-LED Zone Annunciators
 - ✓ LDM Graphic Annunciator Series
 - ✓ LCD-80F Liquid Crystal Display point annunciator
 - ✓ ACM-8RF Relay Module
- Silence inhibit timer option per NAC
- Autosilence timer option per NAC
- Continuous, March Time, Temporal or California code for main circuit board NACs with two-stage capability
- Selectable strobe synchronization per NAC
- Remote Acknowledge, Alarm Silence, Reset and Drill via addressable modules, AFM annunciators or LCD-80F Remote annunciator
- Auto-program (learn mode) reduces installation time. Reports two devices set to the same address
- Password and key-protected nonvolatile memory
- User programmable password
- Fully programmable from local keypad or keyboard or local PC
- SLC operates up to 10,000 ft. (3,000 m) with twisted, shielded wire or 3,000 ft (900 m) with untwisted, unshielded wire
- Compatible with Fire•Lite newer series devices (CLIP Mode)
 - ✓ CP350: addressable Ionization Smoke Detector
 - ✓ SD350(T): addressable Photo Smoke Detector (T= with Thermal Sensor)
 - ✓ H350(R): Fast Response Heat Detector (R=Rate-of-Rise option)
 - ✓ D350P(R): addressable Photo Duct Detector (R=alarm relay option)
 - ✓ B501BH & B501BHT Sounder Base
 - ✓ BB224RB Relay Base
 - ✓ BB224BI Isolator Base
 - ✓ MMF-300: Monitor Module
 - ✓ MDF-300: Dual Monitor Module (uses two consecutive SLC addresses)
 - ✓ MMF-301: Miniature Monitor Module
 - ✓ MMF-302: 2-wire Detector Module
 - ✓ CMF-300: Control Module
 - ✓ CRF-300: Relay Module
 - ✓ BG-12LX: Manual Pull Station
 - ✓ I300: Isolator Module
- Compatible with legacy Fire•Lite 300 Series devices (CLIP Mode only):
 - ✓ CP300: addressable Ionization Smoke Detector
 - ✓ SD300(T): addressable Photoelectric Smoke Detector (T= Thermal Sensor)
 - ✓ C304: Control Module
 - ✓ M300: Monitor Module
 - ✓ M301: Miniature Monitor Module
 - ✓ M302: 2-wire Detector Module
 - ✓ BG-10LX: Manual Pull Station
- Optional 4XTMF module (conventional reverse polarity/city box transmitter)

1.3 Specifications

AC Power - TB1

MS-9600: 120 VAC, 50/60 Hz, 3.2 amps

MS-9600E: 240 VAC, 50 Hz, 1.6 amps

Wire size: minimum 14 AWG (2.00 mm²) with 600 V insulation

Battery (Lead Acid Only) - TB2

Maximum Charging Circuit: Normal Flat Charge - 27.6 VDC @ 1.00 amp

Maximum Battery Charger Capacity: 25 Amp Hour (MS-9600 cabinet holds maximum of two 18 Amp Hour batteries. For greater than 25 Amp Hour up to 120 Amp Hour batteries, use the CHG-120F Battery Charger and BB-55F Battery Box.

Note: Jumper JP3, on the FACP main circuit board, must be cut to disable the FACP battery charger when using the CHG-120F.

Communication Loop - (Standard) TB8 and (Optional SLC Expander Module) J3

24 VDC nominal, 27.6 VDC maximum

Maximum length is 10,000 ft. (3,000 m) total twisted, shielded pair length or 3,000 ft. (900 m) untwisted, unshielded pair length

Maximum loop current is 400 mA (short circuit) or 100 mA (normal)

Maximum loop resistance is 40 ohms

Supervised and power-limited

Refer to SLC Loop manual for wiring information

Notification Appliance Circuits - TB4

Power-limited circuitry

Maximum voltage drop in wiring: 2.0 VDC

Nominal operating voltage: 24 VDC

Current-limit: fuseless, electronic, power-limited circuitry

Maximum signaling current per circuit: 3.00 amps (see Figure 1.1 on page 15)

End-of-Line Resistor: 4.7 k Ω , ½ watt (P/N 71252 UL listed) for NACs

Refer to Fire•Lite Device Compatibility Document for listed compatible devices

Two Programmable and One Fixed Output Relay - TB5

Contact rating: 2.0 amps @ 30 VDC (resistive), 0.5 amps @ 30 VAC (resistive)

Form-C relays

Refer to Figure 2.5 on page 28 for information on power-limited wiring for relay circuits

Four-Wire Resettable Smoke Detector Power (24 VDC nominal) - TB3,

Terminals 1 (+) & 2 (-)

Maximum ripple voltage: 10 mV_{RMS}

Up to 3.0 amps is available for powering 4-wire smoke detectors (see Figure 1.1)

Power-limited circuit

Refer to Fire•Lite Device Compatibility Document for listed compatible devices

Nonresettable Power #1 (24 VDC Nominal) - TB3, Terminals 3 (+) & 4 (-)

Maximum ripple voltage: 10mV_{RMS}

Total DC current available from each output is up to 3.00 amps (see Figure 1.1)

Power-limited circuit

Nonresettable Power #2 (24 VDC Nominal) - TB3, Terminals 5 (+) & 6 (-)

Maximum ripple voltage: 10mV_{RMS}

Total DC current available from each output is up to 3.00 amps (see Figure 1.1)

Power-limited circuit

EIA-485 (ACS) - TB6

ACS annunciator connector, Terminal 1 (+) and Terminal 2 (-)

EIA-485 (TERM) - TB7

Terminal Mode annunciator connector, Terminal 5 (In +), 6 (In -), 7 (Out +), 8 (Out -)

EIA-232 (ACS) - TB7

PC/Printer Connector, Terminal 1 (Transmit), 2 (Receive), 3 (DTR), 4 (Ground)

Auxiliary Trouble Inputs - J16 & J17

Two-pin connectors which can be used to monitor trouble conditions on auxiliary equipment. They can be connected to the trouble bus of a peripheral such as the CHG-120F or to the normally-open dry contacts of a trouble relay.



CAUTION! Do not connect power to these connectors since circuit damage may result.

1.3.1 Current Availability

The following figure illustrates the maximum current that is possible for each panel circuit and the total current available from the FACP power supply.

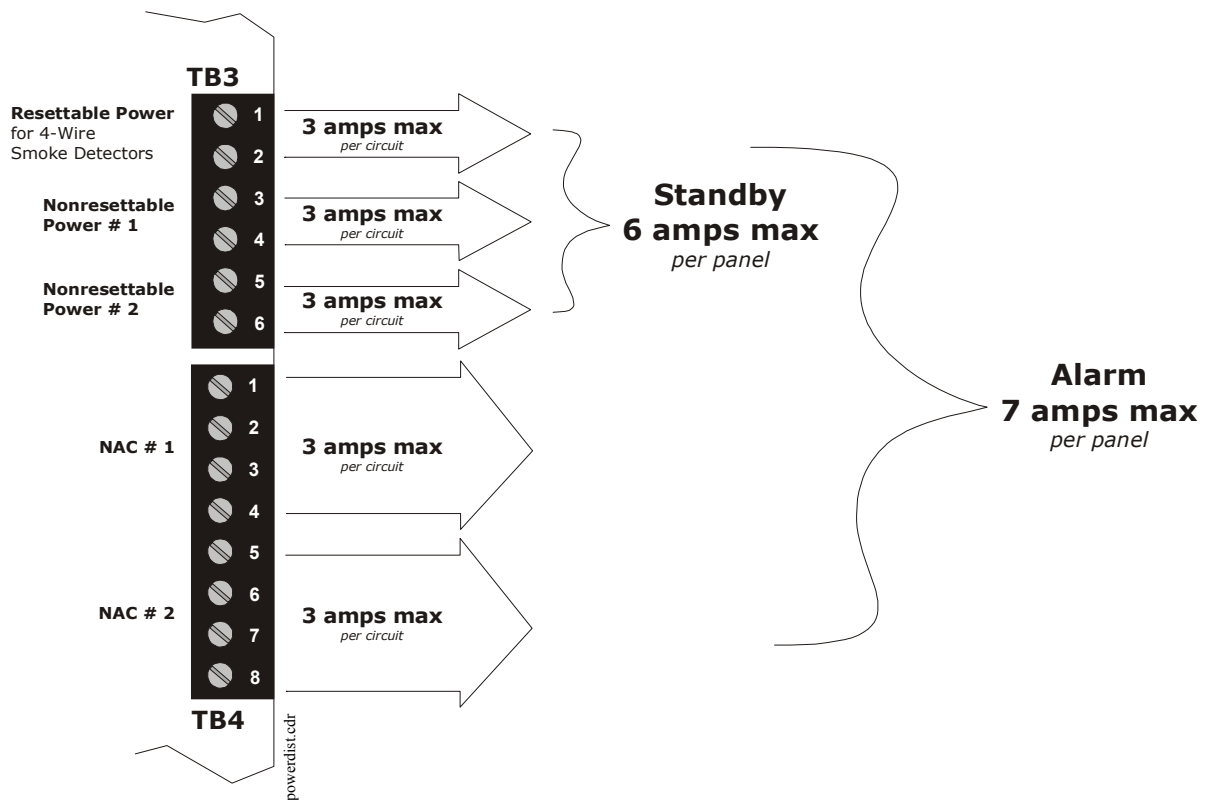

Refer to the battery calculations section for additional information.

Figure 1.1 Current Availability

1.4 Controls and Indicators

LCD Display

The FACP uses an 80-character (4 lines X 20 characters) high viewing angle LCD display. The display includes a long life LED backlight that remains illuminated. If AC power is lost and the system is not in alarm, the LED backlight will turn off to conserve batteries.



FIRE-LITE ALARMS INC
SYSTEM ALL NORMAL
10:00A 010101

LED Indicators

LED indicators are provided to annunciate the following conditions:

- AC Power (green)
- Fire Alarm (red)
- Supervisory (yellow)
- Trouble (yellow)
- Maintenance/presignal (yellow)
- Alarm Silenced signals (yellow)
- Disabled (yellow)
- Battery fault (yellow)
- Ground fault (yellow)

Key Panel

Mounted on the main circuit board, the key panel includes a window for the LCD display and LED indicators as listed above. The key panel, which is visible with the cabinet door closed, has 25 keys, including a 16 key alpha-numeric pad similar to a telephone keypad.

Function keys:

- Acknowledge/Step
- Alarm Silence
- Drill
- Reset (lamp test)

Service/program keys:

- Keys labeled 1 to 9
- * key
- # key
- 0 (recall) key
- 1st Event key
- Clear key
- Escape key
- Mode key
- Four cursor keys (up, down, left and right)
- Enter key

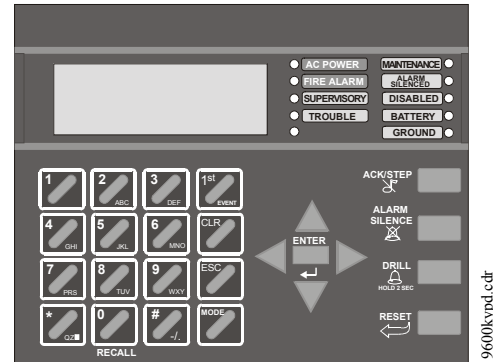

Figure 1.2 Membrane/Display Panel

Local Piezo Sounder

A piezo sounder provides separate and distinct pulse rates for alarm, trouble and supervisory conditions.

1.5 Circuits



SLC Communication Loop

One SLC loop is provided standard on the FACP main circuit board. A second SLC loop is available by plugging the optional SLC module into connector J3 on the main circuit board. SLC loops, configurable for NFPA Style 4, 6 or 7, provide communication to addressable detectors, monitor (initiating device) and control (output device) modules. Refer to the SLC Wiring manual for information on wiring devices.

Output Circuits

The following output circuits are available on the FACP:

- 24 VDC Resettable (smoke detector power) output - 3.00 amps maximum
- 24 VDC Nonresettable power output #1 - 3.00 amps maximum
- 24 VDC Nonresettable power output #2 - 3.00 amps maximum
- 24 VDC Battery Charger (up to 25 AH batteries)

NAC (Notification Appliance Circuits)

Two NACs, configurable for Style Y (Class B) or Style Z (Class A), are provided with various programmable features.

Relays

One fixed and two fully programmable Form-C dry contact relays are provided. The fixed fail-safe relay monitors system trouble and the two programmable relays are factory default programmed for system alarm and system supervisory. Contacts are rated 2.0 amps @ 30 VDC (resistive) and 0.5 amps @ 30 VAC (resistive). The programmable relays can be programmed for the following operations:

- fire alarm
- trouble
- supervisory
- supervisory auto-resettable
- DACT communication failure
- process monitor
- process monitor auto-resettable
- hazard alert
- medical alert
- AC loss

Auxiliary Trouble Inputs

Auxiliary Trouble Inputs can be connected to trouble bus outputs from auxiliary equipment, such as power supplies or normally-open dry contacts of a trouble relay to allow monitoring by the MS-9600.

1.6 Components

Main Circuit Board

The main circuit board contains the system's CPU, power supply, other primary components and wiring interface connectors. Optional modules plug in and are mounted to the main circuit board. The circuit board is delivered in the MS-9600 kit and must be mounted to the backbox. Refer to the circuit board illustration on Page 10.



Cabinet

The MS-9600 cabinet is red with a navy blue front overlay. The backbox provides space for two batteries (up to 18 Amp Hour). Ample knockouts are provided for system wiring. Also included is a standard dress panel, which mounts to the inside of the cabinet (required on the ULC version). The dress panel must be installed to meet FM requirements.

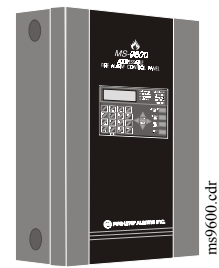

Batteries

The MS-9600 cabinet provides space for two batteries (up to 18 Amp Hour). Batteries larger than 18 Amp Hour up to 25 Amp Hour require use of the Fire•Lite BB-25F or similar UL listed battery cabinet. The CHG-120F can be used for charging 25 to 120 AH batteries and the BB-55F can be used for housing the batteries. Batteries must be ordered separately.

1.6.1 Intelligent Addressable Detectors: Newer Series

Intelligent, addressable detectors provide information to the control panel on an SLC Signaling Line Circuit (refer to the SLC Wiring Manual for detailed information on device installation, wiring and operation). This allows the control panel to continually process the information to determine the status (alarm, trouble, maintenance or normal) of each detector. Each detector responds to an SLC address that is set in the detector head using built-in rotary decimal switches with the ability to select up to 159 addresses. Note that a blinking LED on an intelligent detector indicates communication between the detector and the control panel. Refer to the Fire•Lite Device Compatibility Document for a list of approved detectors.

Smoke Detectors (Photoelectric)

The SD350 is an intelligent, addressable low profile photoelectric smoke detector which provides smoke sensing technology. The SD350T includes a 135° fixed thermal sensor.

Smoke Detector (Ionization)

The CP350 is an intelligent, addressable low profile ionization smoke detector which measures the level of combustion products in its chamber using the 'ionization principle.'

Smoke Detector (Duct)

The D350P is an intelligent, addressable photoelectric duct smoke detector. The D350RP includes an alarm relay.

Heat Detectors

The H350 is an intelligent heat detector with a thermistor sensing circuit for fast response, designed to provide open area protection with 50 foot (15 m) spacing capability. The H350R incorporates a thermal Rate-of-Rise circuit of 15°F (9.4°C).

Detector Bases

The **B501BH** is a standard sounder base and the **B501BHT** is a temporal tone sounder base for intelligent, addressable smoke detectors.

The **B224RB** is a relay base with one Form-C relay for intelligent, addressable smoke detectors. It may be used to control auxiliary functions.

The **B224BI** is an isolator base for intelligent, addressable smoke detectors. It functions similar to the I300 isolator module which allows loops to operate under fault conditions and automatically restore when the fault is removed.

1.6.2 Intelligent Addressable Modules: Newer Series

The newer series of Control Modules and Monitor Modules provide an interface between the control panel and conventional notification and initiating devices. Each module can be set to respond to an address with built-in rotary switches with the ability to select up to 159 addresses (a tab on the address switch must be broken off to use addresses 100-159). A blinking LED on a monitor module indicates communication between the module and the control panel. These devices can also be used in CLIP Mode (Classic Loop Interface Protocol) when installed on older systems. *Refer to the Fire•Lite Device Compatibility Document for a list of approved notification and initiating devices.*



Monitor Modules

The MMF-300, MDF-300 and MMF-302 are addressable monitor modules for monitoring conventional initiating devices. The MMF-300 is used for normally open contact alarm initiating devices, such as manual pull stations, four-wire smoke detectors, heat detectors, waterflow, security contacts and supervisory devices. The MDF-300 is a dual monitor module (Class B only) which occupies two consecutive SLC addresses, with each module functionally the same as the MMF-300. The MMF-302 is used primarily for two-wire smoke detectors in addition to normally open contact devices. The supervised IDCs (Initiating Device Circuits) can be wired to the modules as NFPA Style B (Class B) or Style D (Class A) circuits. The modules are supplied with a thermoplastic cover for mounting to a 4-inch mounting box.

Monitor Module (miniature)

The MMF-301 is an addressable module that is functionally similar to an MMF-300 but offered in a smaller package for mounting directly in the electrical box of the device being monitored.

Control Module

The CMF-300 is an addressable Control Module used to connect NACs (Notification Appliance Circuits) to power and supervise compatible, UL-listed notification appliances. The NACs can be wired to the module as supervised NFPA Style Y (Class B) or Style Z (Class A) circuits. The modules are supplied with a thermoplastic cover for mounting to a 4-inch square mounting box.

Relay Module

The CRF-300 is a Control Relay Module which is functionally similar to the CMF-300 but used as a Form-C relay module.

Isolator Module

The I300 loop isolator module is an automatic switch which opens the circuit voltage to the SLC loop branch(es) whenever a wire-to-wire short circuit is detected on that loop. The remainder of the communications loop leading up to the I300 will continue to operate, unaffected by the short. The isolator module is bidirectional, meaning that it can detect a fault condition between the input SLC terminals or output SLC terminals. The I300 is required to meet NFPA Style 7 requirements.

Detector Annunciator

The RA400Z is a remote single LED annunciator that can be wired directly to an addressable detector for annunciation of that detector's alarm status.

Manual Pull Station

The BG-12LX is an addressable manual pull station featuring a key-lock reset. The pull station responds to an address set by the installer using the built-in rotary decimal switches on the pull station. The manual pull station includes a Fire•Lite key.

1.6.3 300 Series Intelligent Addressable Devices

Fire•Lite's 300 Series Intelligent Addressable Devices are fully compatible with the MS-9600 FACP. The devices must be configured for CLIP Mode operation if the control panel is installed in an existing system with 300 Series devices. The address of 300 Series devices cannot be set above 99. Compatible devices include:

- SD300 Photoelectric Detector
- SD300T Photoelectric Detector with Thermal Sensor
- CP300 Ionization Detector
- M300 Monitor Module
- M301 Miniature Monitor Module
- M302 2-wire Monitor Module
- C304 Control/Relay Module
- BG-10LX Manual Pull Station

1.6.4 Addressable Device Accessories

End-of-Line Resistor Assembly Fire•Lite P/N R-47K

The 47 k Ω End-of-Line Resistor assembly (P/N: R-47K) is used to supervise the MMF-300, MDF-300, MMF-301 and CMF-300 module circuits. The 3.9 k Ω End-of-Line Resistor assembly is used to supervise the MMF-302 module circuit. The resistors are included with each module.

Power Supervision Relay

The UL listed End-of-Line power supervision relay is used to supervise the power to 4-wire smoke detectors and notification appliances.

N-ELR Mounting Plate

The N-ELR is a single End-of-Line resistor plate which is required for use in Canada. An ELR, which is supplied with each module and fire alarm control panel, is mounted to the ELR plate. Resistors mounted to the N-ELR plate can be used for the supervision of a monitor and control module circuit.

1.7 Optional Modules

The MS-9600 main circuit board includes option module connectors for the following modules:

4XTMF Transmitter Module

The 4XTMF provides a supervised output for local energy municipal box transmitter, alarm and trouble reverse polarity. It includes a disable switch and disable trouble LED. A jumper on the module is used to select an option which allows the reverse polarity circuit to open with a system trouble condition if no alarm condition exists. The module plugs into connectors J10 and J11 which are located near the top center of the main circuit board. When the 4XTMF module is installed, Jumper JP6, on the main circuit board, must be cut to allow supervision of the module.

SLC-2 Expander Module

The SLC-2 Expander Module allows expansion of the MS-9600 from one SLC circuit to two SLC circuits. The module plugs into connector J3 which is located in the lower right corner of the main circuit board. The wiring for the second SLC connects to terminals located on the expander module.

1.8 Accessories

1.8.1 PK-9600 Programming Utility

The PK-9600 Programming Utility can be used to program an MS-9600 directly from most IBM compatible computers, including laptops and portables, equipped with a serial port. MS-9600 program files can also be created and stored on the PC and then downloaded to the control panel. The PK-9600 Kit includes the MS-9600 Windows-based Programming Utility software on CD-ROM with on-line help file. A serial cable (P/N: PRT/PK-CABLE), which must be purchased separately, is required for connection of the PC to the RS-232 (PC/Printer) terminals at TB7 of the MS-9600 main circuit board. Refer to the illustration on page 10 and the section titled "Printer/PC" on page 34, for the location and connections to this terminal.

1.8.2 Dress Panel

A dress panel is provided standard with the MS-9600 (required for Canadian installations). The dress panel restricts access to the system wiring while allowing access to the key panel.

Note that the MS-9600 FACP, installed with the dress panel, has received Factory Mutual (FM) approval. FM approval is contingent on the proper installation of the dress panel.

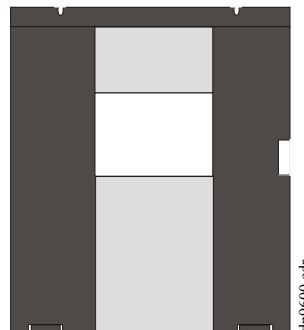

1.8.3 Battery Box

BB-17F

The BB-17F battery box may be used to house up to two 18 AH batteries in the event that room is not available in the main cabinet due to the use of a UDACT-F, 411UD, etc. The battery box mounts directly below the FACP cabinet. The battery box is red and is provided with knockouts.

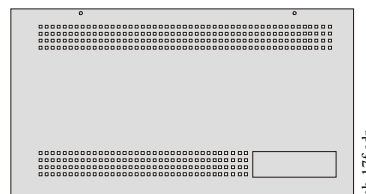

BB-55F

The BB-55F battery box may be used to house two 25 AH batteries, two 60 AH batteries or one 100 AH battery. When the CHG-120F is mounted in the BB-55F, two 25 AH or one 60 AH battery may also be housed in the battery box.

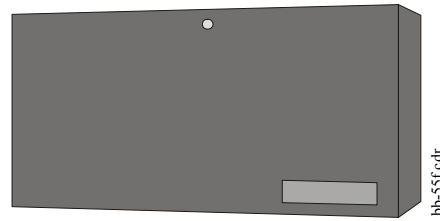
**1.8.4 CHG-120F Battery Charger**

The CHG-120F is capable of charging up to 120 AH lead-acid batteries with the MS-9600 FACP. The FACP battery charger must be disabled when using the CHG-120F. The batteries and charger can be housed in the Fire•Lite BB-55F battery box which can be mounted up to 20 feet away from the control panel. Note that when using the BB-55F for housing the charger and batteries greater than 25AH, multiple BB-55Fs are required. Refer to the CHG-120F Manual for additional information.

Reference
Manual**1.8.5 Annunciators****ACM Series LED Zone Type Annunciators**

The ACM Series Annunciators remotely display alarm and trouble status as well as system status. In addition, they can provide remote Acknowledge, Silence, Reset and Drill functions. For more detailed information, refer to the appropriate annunciator manual. Following is a list of annunciators which can be used with the MS-9600.

Reference
Manual

- ACM-16ATF Annunciator Control Module annunciates 16 zones with 16 red alarm LEDs and 16 yellow trouble LEDs. In addition, it has a System Trouble LED, an On Line/Power LED and a local piezo sounder. It also has switches for FACP Acknowledge, Silence, Reset and Drill. It has rotary address switches and will accept up to three AEM-16ATF Expanders
- AEM-16ATF Annunciator Expander Module annunciates 16 zones with 16 red alarm LEDs and 16 yellow trouble LEDs
- AFM-16ATF Annunciator Fixed Module annunciates 16 zones with 16 red alarm LEDs and 16 yellow trouble LEDs. In addition, it has a System Trouble LED, an On Line/Power LED and a local piezo sounder. It also has switches for FACP Acknowledge, Silence, Reset and Drill. It is fixed at address '1'
- ACM-32AF Annunciator Control Module annunciates 32 alarm zones with 32 red LEDs. In addition, it has a System Trouble LED, an On Line/Power LED and a local piezo sounder. It also has a switch for local piezo silence. It has rotary address switches and will accept one AEM-32AF Expander
- AEM-32AF Annunciator Expander Module annunciates 32 alarm zones with 32 red LEDs
- AFM-16AF Annunciator Fixed Module annunciates 16 alarm zones with 16 red alarm LEDs. In addition, it has a System Trouble LED, an On Line/Power LED and a local piezo sounder. It also has a switch for local piezo silence. It is fixed at address '1'
- AFM-32AF Annunciator Fixed Module annunciates 32 alarm zones with 32 red LEDs

LCD-80F Remote Fire Annunciator

The LCD-80F annunciator is a compact 80-character backlit LCD remote fire annunciator that is capable of displaying English language text. It mimics the display on the control panel and will annunciate device type, point alarm, trouble or supervisory condition, zone assignment plus any custom alpha labels programmed into the FACP. The annunciator also provides system status LEDs to display AC Power, Alarm, Trouble, Supervisory and Alarm Silenced conditions. Additionally, the LCD-80F is capable of remotely performing critical system functions such as Acknowledge, Silence, Reset and Drill.

Communications between the control panel and the annunciator is accomplished over a serial interface employing the EIA-485 communication standard. Up to 32 LCD-80F annunciators may be connected to the EIA-485 circuit. The annunciators may be powered from the host FACP or a remote UL listed filtered power supply such as the Fire•Lite FCPS Series. For more detailed information, refer to the LCD-80F manual.



LDM Series Lamp Driver Modules (Graphic Annunciator)

The LDM Series Lamp Driver Modules, which consist of the LDM-32F master and LDM-E32F expander modules, are used to provide an interface to a custom graphic LED annunciator. The master module provides power and control for a maximum of three expander modules. The LDM-32F and LDM-E32F have output connectors which are used to drive lamps or LEDs and input connectors which are used for remote switch functions. Refer to the LDM Series Lamp Driver Modules manual for a complete description.



1.9 Getting Started

The following is a brief summary of the minimal steps involved in bringing an MS-9600 on-line:

- Install Backbox and Main Circuit Board (refer to "Mounting" on page 24)
- Address and Install Intelligent Devices (refer to the SLC Wiring Manual)
- Enter Autoprogramming (refer to "Autoprogram" on page 87)
- Resolve Programming Conflicts
- Go to Point Program to Enter Specific Data (refer to "Point Program" on page 43). Use the right and left arrow keys to navigate between devices.

SECTION 2 Installation

The cabinet may be either semi-flush or surface mounted. The cabinet mounts using two key slots and two 0.250" (6.35 mm) diameter holes located in the backbox. The key slots are located at the top of the backbox and the two securing holes at the bottom.

Carefully unpack the system and check for shipping damage. Mount the cabinet in a clean, dry, vibration-free area where extreme temperatures are not encountered. The area should be readily accessible with sufficient room to easily install and maintain the panel. Locate the top of the cabinet approximately 5 feet (1.5 m) above the floor with the hinge mounting on the left. Determine the number of conductors required for the devices to be installed. Sufficient knockouts are provided for wiring convenience. Select the appropriate knockout(s) and pull the conductors into the box. All wiring should be in accordance with the National and/or Local codes for fire alarm systems.

2.1 Mounting



The circuit board contains static-sensitive components. Always ground yourself with a proper wrist strap before handling any boards so that static charges are removed from the body. Use static suppressive packaging to protect electronic assemblies.



See Page

- ✓ Mark and predrill holes in the wall for the top two keyhole mounting bolts using the dimensions illustrated in Figure 2.2 on page 25
- ✓ Install two upper fasteners in the wall with the screw heads protruding
- ✓ Using upper 'keyholes,' place backbox over the two screws, level and secure
- ✓ Mark and drill the lower two holes
- ✓ Install remaining fasteners and tighten
- ✓ Screw supplied standoffs onto mounting studs in locations indicated below
- ✓ When the location is dry and free of construction dust, install the main circuit board by aligning the 10 mounting holes in the circuit board with the 10 mounting standoffs in the backbox as illustrated below
- ✓ Secure the circuit board to the standoffs with the supplied screws and male/female standoff as indicated in following figure

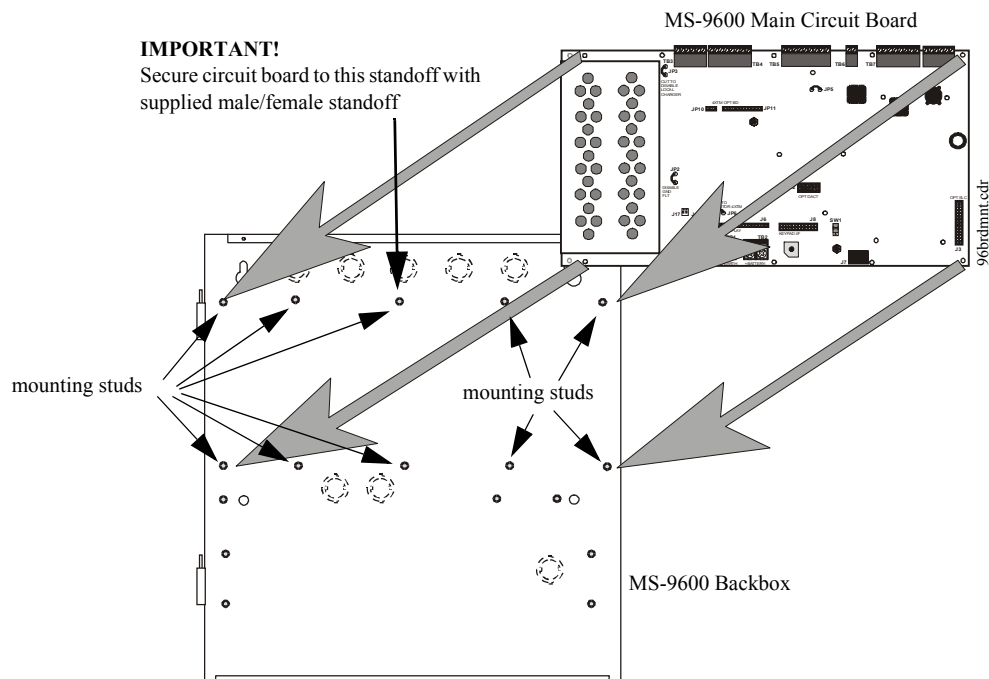

Figure 2.1 MS-9600 Main Circuit Board Installation

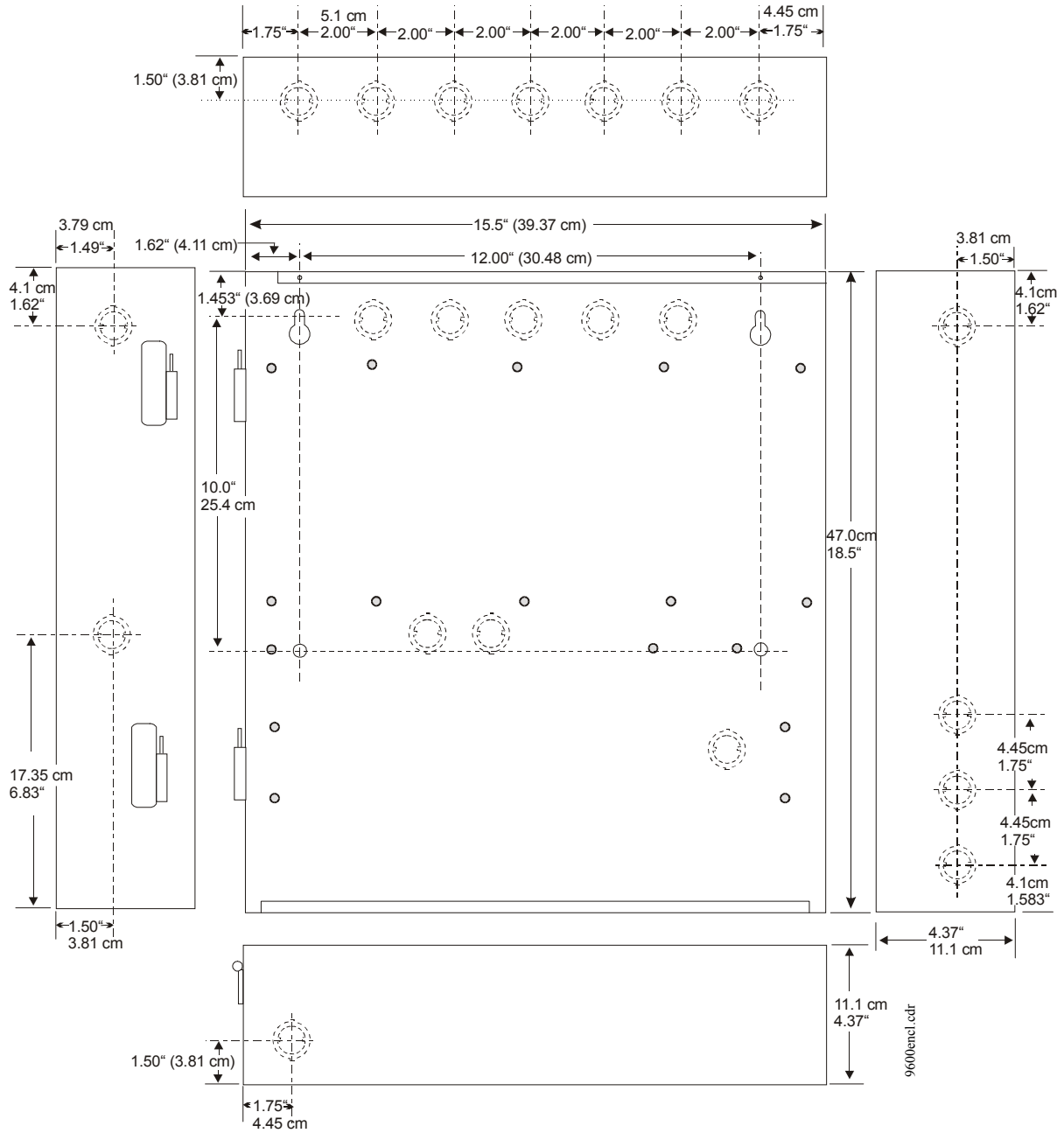

Figure 2.2 MS-9600 Cabinet Mounting

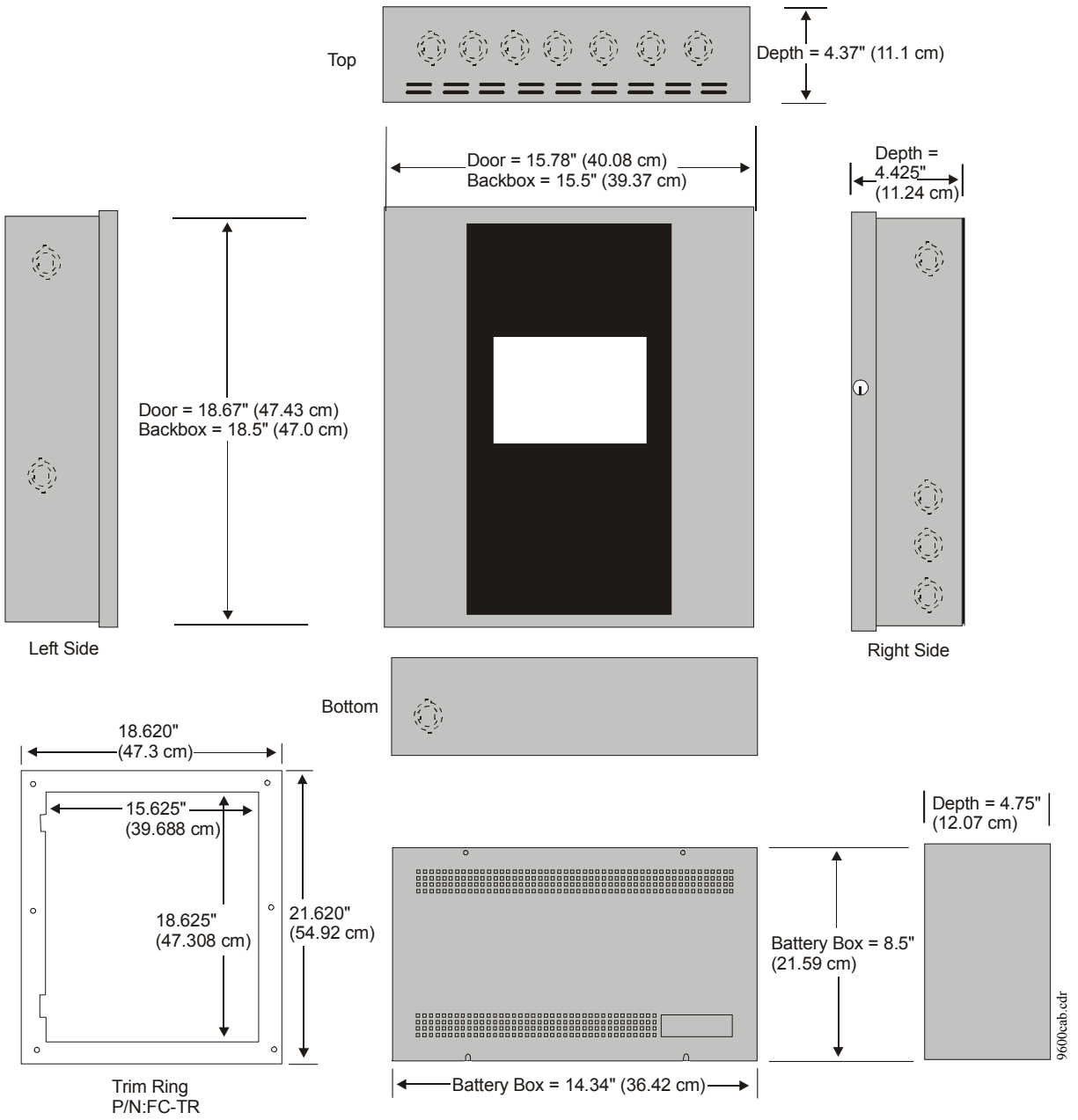

Figure 2.3 MS-9600 Cabinet Dimensions

2.2 Power

WARNING: Several different sources of power can be connected to this panel. Disconnect all sources of power before servicing. The panel and associated equipment may be damaged by removing and/or inserting cards, modules or interconnecting cables while this unit is energized.

2.2.1 AC Power and Earth Ground Connection

Primary power required for the FACP is 120 VAC, 50/60 Hz, 3.2 amps for the MS-9600 or 220/240 VAC, 50/60 Hz, 1.6 amps for the MS-9600E. Overcurrent protection for this circuit must comply with Article 760 of the National Electrical Code (NEC) and/or local codes. Use 14 AWG (2.00 mm²) or larger wire with 600 volt insulation rating. Make certain that the AC mains circuit breaker is off before wiring any connections between the mains and the control panel. Connect wiring from the AC mains to TB1 on the FACP, being careful to observe proper connections.

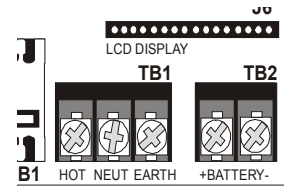

Connect a wire from the grounding stud in the cabinet to a known solid earth ground. This connection is vital for maintaining the control panel's immunity to unwanted transients generated by lightning and electrostatic discharge. Apply AC power to the panel only after the system is completely installed and visually checked. *Note that AC power must be applied to the panel before installing the battery interconnect cable (refer to the following section).*

2.2.2 Battery Power

Before connecting the batteries to the FACP, make certain that the interconnect cable between the batteries is not connected. Do not connect the interconnect cable until the system is completely installed. Observe polarity when connecting the batteries. Connect the battery cable to TB2 on the main circuit board. Refer "Power Supply Calculations" on page 127, for calculation of the correct battery rating.

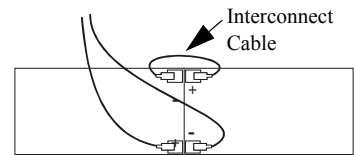

 See Page

WARNING: Battery contains sulfuric acid which can cause severe burns to the skin and eyes and can destroy fabrics. If contact is made with sulfuric acid, immediately flush the skin or eyes with water for 15 minutes and seek immediate medical attention.

2.2.3 DC Power Output Connection

All DC power outputs are power-limited.

Power-limited Resettable Power
3.0 amperes max., 24 VDC nominal filtered, resettable power can be drawn from TB3 Terminals 1(+) and 2(-)

Power-limited Nonresettable Power #1
3.0 amperes max., 24 VDC nominal filtered, nonresettable power can be drawn from TB3 Terminals 3(+) and 4(-)

Power-limited Nonresettable Power #2
3.0 amperes max., 24 VDC nominal filtered, nonresettable power can be drawn from TB3 Terminals 5(+) and 6(-)

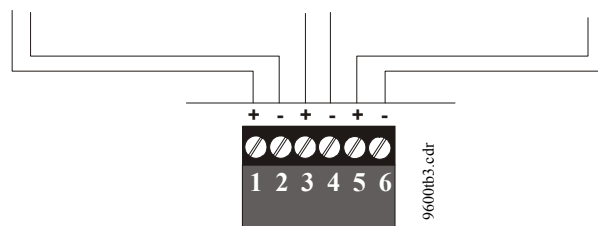

Figure 2.4 Power Outputs - 24 VDC

2.3 Relays

The FACP provides two programmable Form-C relays and one fixed fail-safe Form-C trouble relay, all with contacts rated for 2.0 amps @ 30 VDC (resistive) or 0.5 amps @ 30 VAC (resistive). The Alarm and Supervisory silk-screen labels reflect the factory default programming for the two programmable relays.

Note that relay connections may be power-limited or nonpower-limited, provided that 0.25" spacing is maintained between conductors of power-limited and nonpower-limited circuits. Refer to UL Power-limited wiring requirements.

Note that the relays labeled as Alarm Relay (Relay 1) and Supervisory Relay (Relay 3) reflect the factory default programming for these relays which are programmable. The relay labeled Trouble Relay (Relay 2) is fixed and cannot be changed. It is a fail-safe relay which will transfer on any trouble or total power failure.

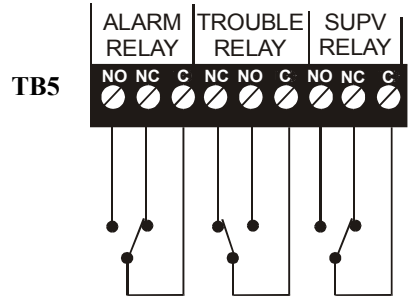

Relay contacts shown with power applied to panel and no active troubles, alarms or supervisories

Figure 2.5 Relay Terminals

2.4 Notification Appliance Circuits



The control panel provides two NAC (Notification Appliance Circuits) configurable for Style Y/Class B or Style Z/Class A. Each circuit is capable of 3.0 amps of current. Total system current cannot exceed 7.2 amps (refer to "Calculating the System Current Draw" on page 128). Use UL listed 24 VDC notification appliances only. Circuits are supervised and power-limited. Refer to the Fire•Lite Device Compatibility Document for a listing of compatible notification appliances. The two NACs, which are located on the main circuit board, may be expanded via the Fire•Lite FCPS Series field charger/power supplies. Surge protection for notification appliances may be provided by using one of the UL listed compatible surge suppressors listed in the Fire•Lite Device Compatibility Document.

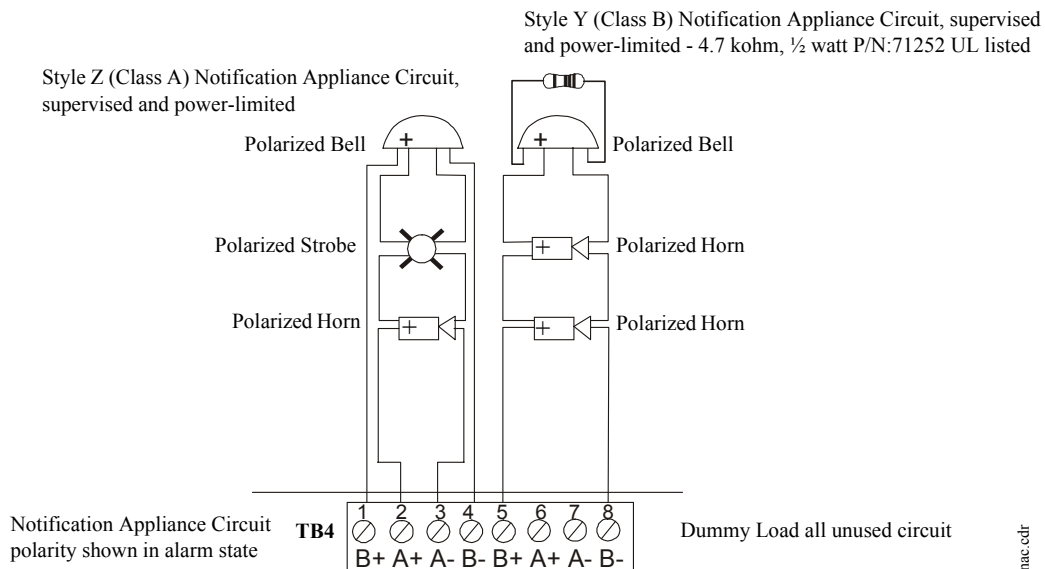

Figure 2.6 NAC Connections

2.5 UL Power-limited Wiring Requirements

Power-limited and nonpower-limited circuit wiring must remain separated in the cabinet. All power-limited circuit wiring must remain at least 0.25" (6.35 mm) away from any nonpower-limited circuit wiring and nonpower-limited circuit wiring must enter and exit the cabinet through different knockouts and/or conduits. A typical wiring diagram for the MS-9600 is shown below.

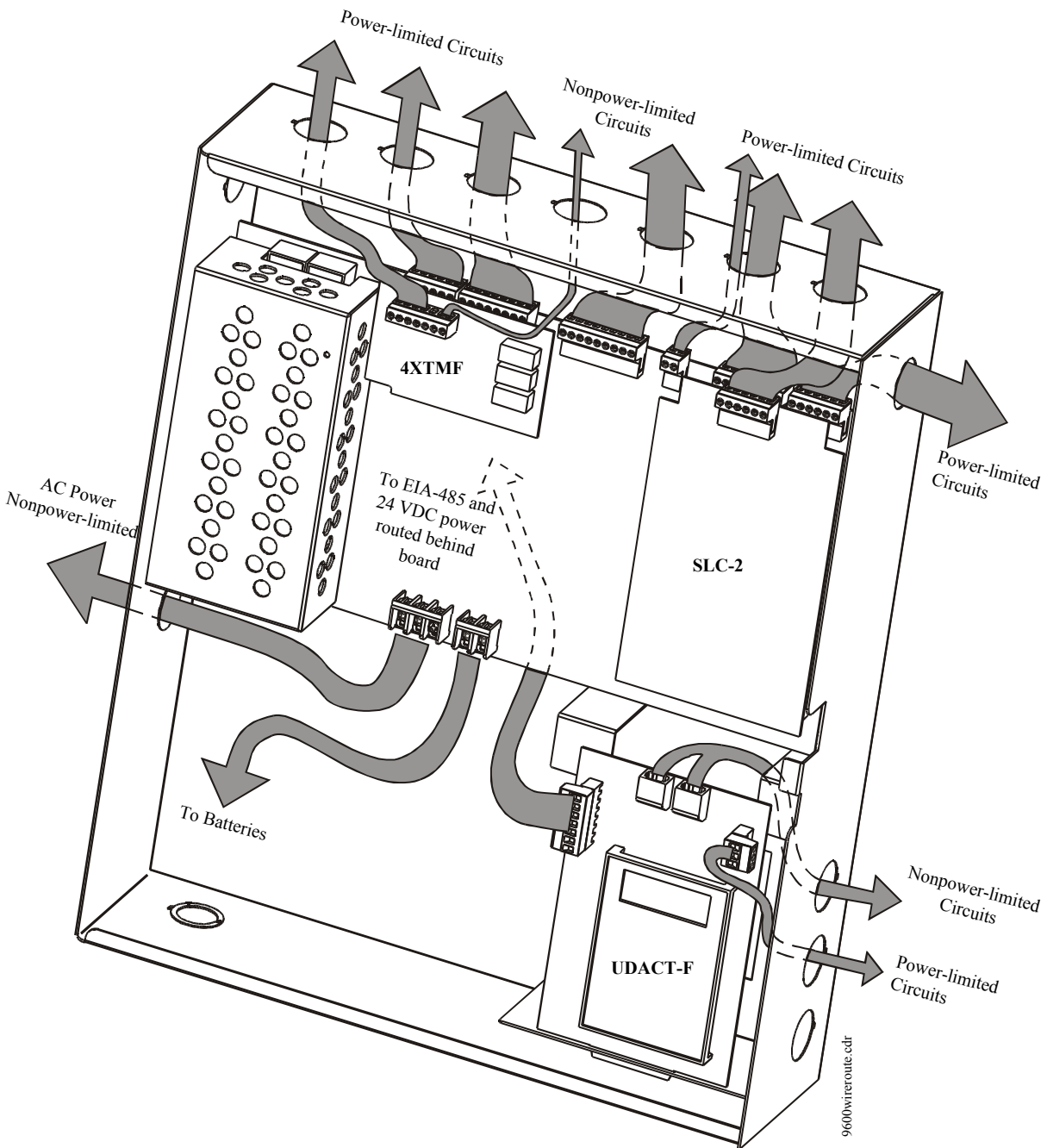

Figure 2.7 Typical UL Power-limited Wiring Requirements

2.6 Optional Modules and Devices

⚡ WARNING! Disconnect all sources of power (AC and DC) before installing or removing any modules or wiring.

MS-9600 Keypad/Display Removal

Removal of the keypad/display is normally not necessary. If, however, it becomes necessary to replace the keypad/display, access the auxiliary trouble bus connectors at J16 and J17 or install future option modules, the Keypad/Display can be removed by inserting a Phillips screwdriver into each of the three holes located in the flexible covering of the Keypad/Display and loosening the three mounting screws. Note that it is not necessary to disconnect the cables between the Keypad/Display and the main circuit board unless the unit itself is being replaced. Carefully lift the Keypad/Display and rest the unit at the bottom of the main circuit board.

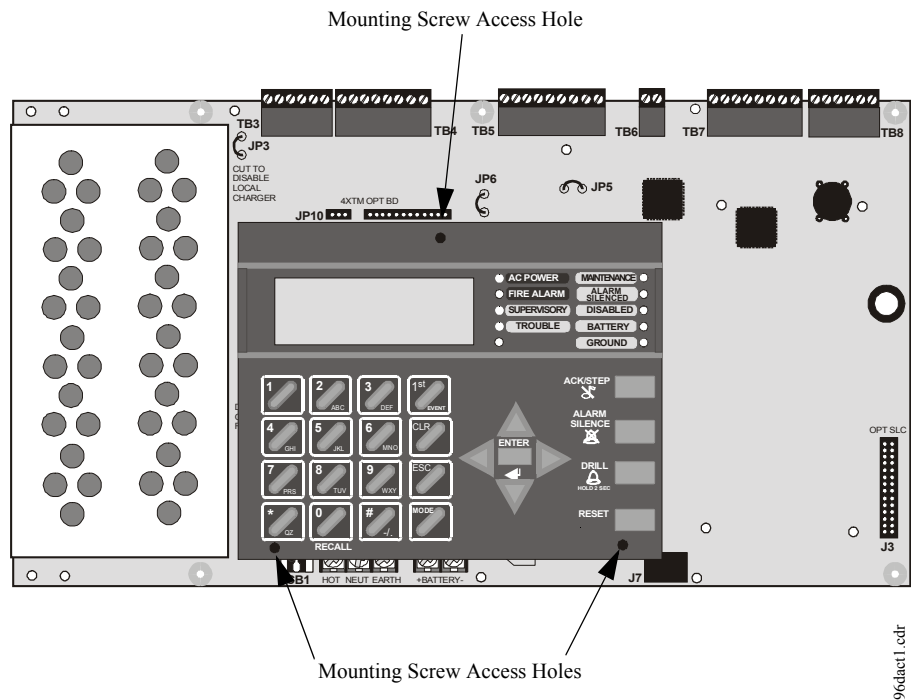

Figure 2.8 Keypad/Display Removal

2.6.1 4XTMF Transmitter Module Installation

The 4XTMF provides a supervised output for a local energy municipal box transmitter in addition to alarm and trouble reverse polarity. A jumper option allows the reverse polarity circuit to open with a system trouble condition if no alarm condition exists. A disable switch allows disabling of the transmitter output during testing to prevent accidental calling of the monitoring service.

Local Energy Municipal Box Service (NFPA 72 Auxiliary Fire Alarm Systems):

- Supervisory Current: 5.0 mA
- Trip Current: 350 mA (subtracted from notification appliance power)
- Coil Voltage: 3.65 VDC
- Maximum Coil Resistance: 14.6 ohms
- Maximum allowable wire resistance between panel and trip coil: 3 ohms
- Municipal Box wiring can leave the building

Remote Station Service (NFPA 72 Remote Station Fire Alarm Systems) - Intended for connection to a polarity reversal circuit or a Remote Station receiving unit having compatible ratings:

- Maximum load for each circuit: 10 mA
- Reverse polarity output voltage: 24 VDC
- Remote Alarm and Remote Trouble wiring can leave the building

Before installing the module, place the disconnect switch to the right (disconnect) position to prevent accidental activation of the municipal box. Note that a Disconnect LED will illuminate after the module is installed in the MS-9600. In addition, the System Trouble LED will turn on to indicate the Disconnect condition.

Note: 4XTMF Module is not suitable for transmitting reverse polarity supervisory signal.

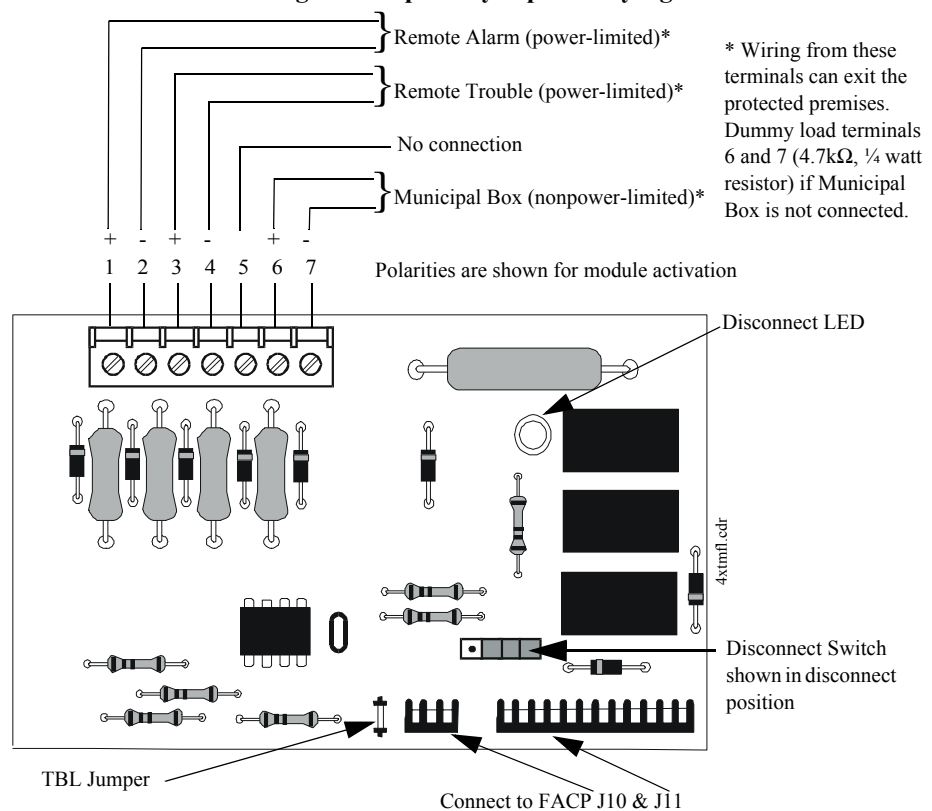

Figure 2.9 4XTMF Transmitter Module

The following steps must be followed when installing the 4XTMF module:



1. Remove all power (AC and DC) from the FACP before installing 4XTMF
2. Cut jumper JP6 on the main circuit board to allow the control panel to supervise the 4XTMF module
3. Carefully plug the connectors on the 4XTMF module into connectors J10 and J11 on the MS-9600 main circuit board, being careful not to bend any pins
4. Secure 4XTMF module to standoffs with supplied screws.
5. Reapply power to the FACP
6. For proper 4XTMF operation, the output relays must be programmed for the factory default settings as shown on the PC board silkscreen: Alarm Relay, Trouble Relay and Supervisory Relay
7. When the installation has been complete, enable the 4XTMF module by sliding the disconnect switch to the left
8. Test system for proper operation

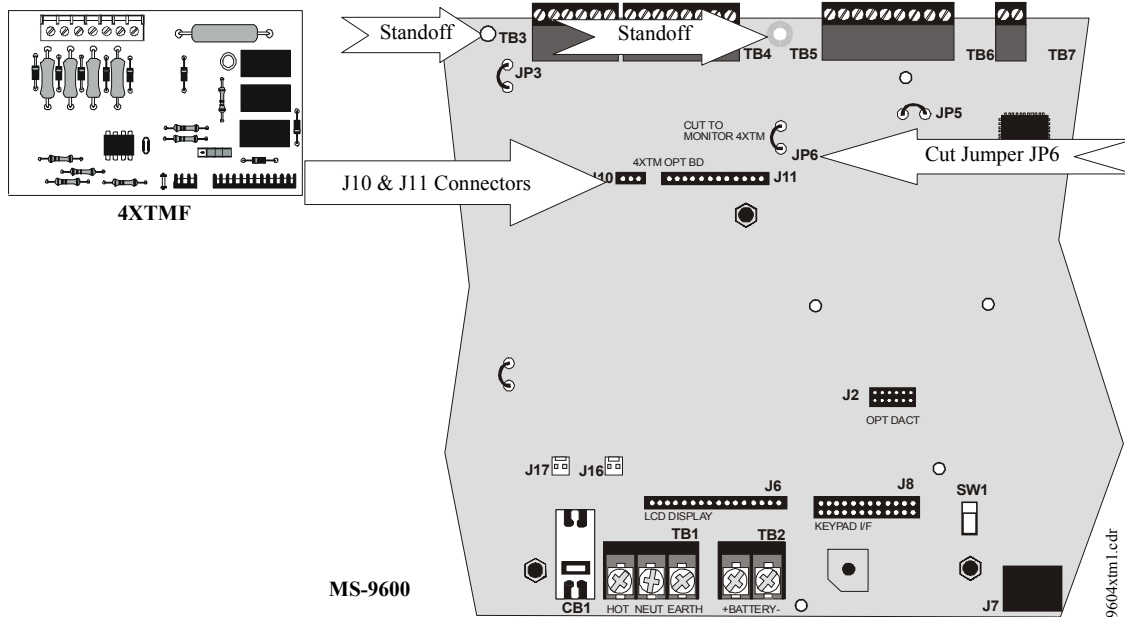

Figure 2.10 4XTMF Connectors to MS-9600 Connectors

NOTE: Jumper JP5 on the MS-9600 main circuit board can be used to configure the FACP supervisory relay for operation with the 4XTMF module. The supervisory relay must be programmed as shown on the main circuit board silkscreen (TB5, Terminals 4, 5 & 6). Cutting JP5 will allow the 4XTMF to generate a trouble if the supervisory contact opens. Leaving JP5 in will prevent generation of a trouble if the supervisory contact opens.

2.6.2 Auxiliary Trouble Input (J16 & J17)

Auxiliary Trouble Inputs 1 (J17) and 2 (J16), which are located on the MS-9600 main circuit board, can be used to monitor for trouble conditions on auxiliary equipment such as power supplies. J16 and/or J17 can be connected to any open collector trouble output on the auxiliary equipment. The MS-9600 control panel will indicate a trouble condition if a trouble is sensed at the Auxiliary Trouble Inputs.

If the 4XTMF Module is installed and jumper JP6 on the MS-9600 has been cut to supervise it, Auxiliary Trouble Input 1 (J17) will monitor the 4XTMF for trouble conditions.

2.6.3 SLC-2 Expander Module

The optional SLC-2 Expander Module provides a second SLC loop for the MS-9600 control panel. This allows connection of an additional 318 addressable devices, bringing the total to 636 addressable devices which can be connected to the FACP. Refer to the SLC Manual for information on connecting devices to the SLC.



The following steps must be followed when installing the SLC-2 Expander Module:



1. Remove all power (AC and DC) from the FACP before installing the SLC-2 module

2. Carefully plug connector J3 on the SLC-2 module into connector J3 on the MS-9600 main circuit board, being careful not to bend any pins

3. Secure the SLC-2 Expander Module to the four standoffs on the FACP main circuit board with the supplied screws

4. Connect the SLC wiring and devices to TB8 on the SLC Expander Module. Refer to the SLC Manual for wiring information

5. Reapply power to the control panel



6. Program the addressable devices connected to the SLC-2 Expander Module as detailed in "Master Programming Level" on page 42

7. Test the system for proper operation

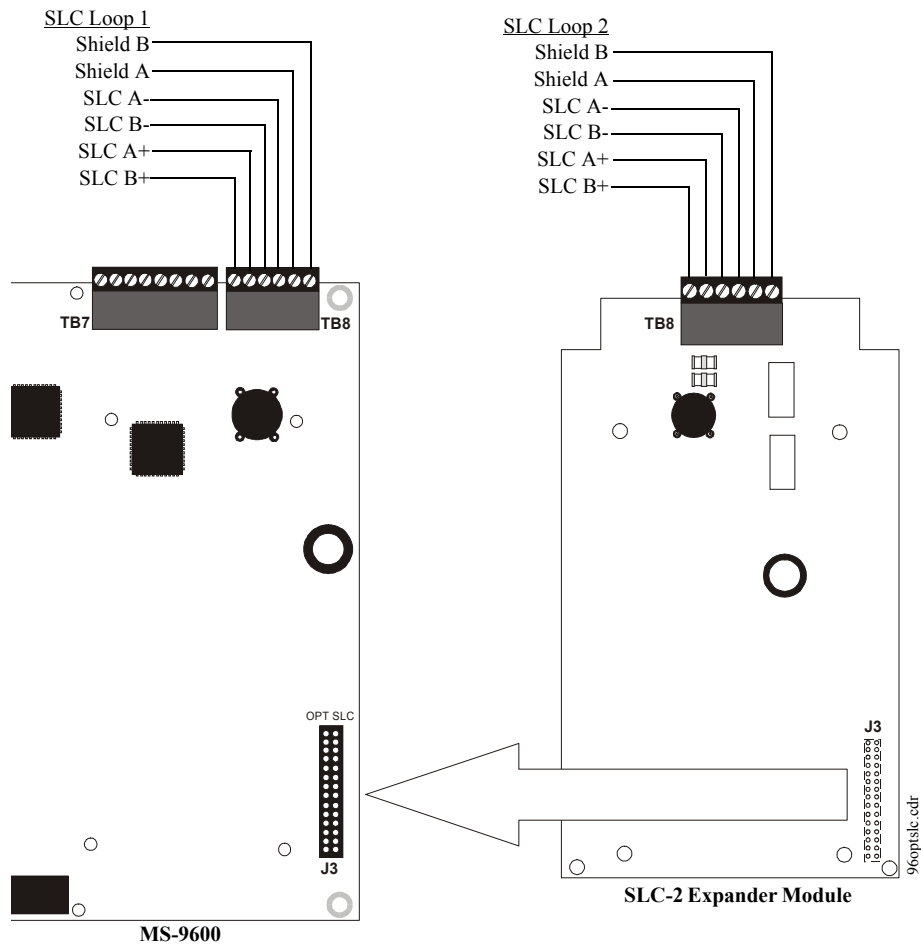

Figure 2.11 SLC-2 Expander Module Installation

2.6.4 Printer/PC

A serial printer or a PC (personal computer) may be connected to TB7 Terminals 1 - 4 on the FACP. The printer can be used to provide a hard-copy printout of real-time events, history file and walktest data. An IBM compatible PC can be connected to provide local FACP programming capabilities using the PK-9600 programming utility. Installation of either device requires panel programming to allow the FACP to communicate with the device.



CAUTION! Do not connect a printer or PC to the MS-9600 FACP if a ground fault exists on the control panel. Circuit damage may result. Remove all power (AC and DC) before installing or removing any wiring.

Installation

Remote printers and PCs require separate primary power. Also required is the PRT/PK-CABLE which is an interface cable prewired to a DB9F connector. Wire the PRT/PK-CABLE to TB7 Terminals 1 - 4 as illustrated in the following figure. Connect the DB9F connector to the printer or PC serial EIA-232 port. If a nine-pin serial connector is not available on the printer or PC, use a DB25 adapter. Make certain that the DB25 adapter does not swap the Transmit and Receive lines. Apply power to the FACP and printer or PC. Note that a ground fault may occur on the FACP, dependent on the printer or PC being used, due to this connection. For this reason, it is important that there be no preexisting ground fault on the panel.

Note that the printer may or may not be supervised as determined by user programming. Refer to "Printer/PC" on page 92.

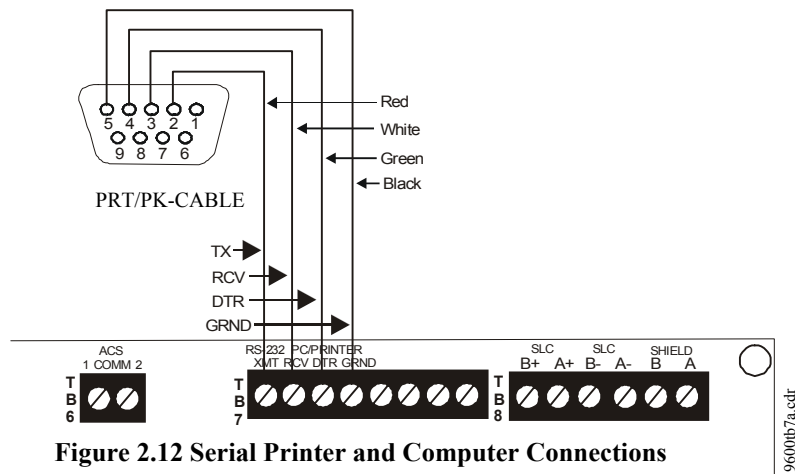

Figure 2.12 Serial Printer and Computer Connections

Printer Configuration

Refer to the documentation supplied with the printer for pertinent information about printer setup. Set the printer's options as listed in the following table:

COMMUNICATION SETUP	
BUFFER:	LARGE
DATA BITS:	7
PARITY:	EVEN
STOP BIT:	1 STOP
BAUD RATE:	2400/4800/9600
AUTOMATIC LINE FEED	NO
AUTOMATIC CARRIAGE RETURN	NO

PC Configuration

The Windows-based PK-9600 Programming Utility Kit contains CD-ROM with on-line help file.

2.6.5 Digital Communicator and Annunciators

2.6.5.1 UDACT-F Digital Alarm Communicator/Transmitter



Reference
Manual

The UDACT-F transmits system status to UL listed Central Station receivers via the public switched telephone network. It is capable of reporting up to 99 software zones or up to 636 addressable points. The UDACT-F can be mounted remotely in a UBS-1F or ABS-8RF enclosure or in the panel cabinet using the P/N: BRKT-9600 Universal Bracket. For additional information, refer to the UDACT-F Manual.

Programming



See Page

The MS-9600 must be programmed to operate with the UDACT-F. Refer to "Annunciators/UDACT" on page 91 for control panel programming information.

2.6.5.2 ACM-8RF Relay Control Module



Reference
Manual

The ACM-8RF module provides eight Form-C relays with contacts rated for 5 amps. When installed with an MS-9600 FACP, the ACM-8RF modules provide relay activation for each of the 99 possible FACP zones plus special functions. Options exist to allow for alarm only or alarm and trouble activation per zone. Output activation for general alarm, general trouble, general supervisory, NAC fault, AC fail, walktest start and battery trouble are also available. The ACM-8RF can be mounted remotely in an ABS-8RF annunciator surface-mount backbox or in the panel cabinet using the P/N: BRKT-9600 Universal Bracket. Refer to the ACM-8RF manual for information on setting module switches for addressing and relay functions.

2.6.5.3 BRKT-9600 Universal Bracket Installation

The optional BRKT-9600 Universal Bracket can be used to mount specific modules inside the MS-9600 cabinet. The BRKT-9600 mounts to two studs located in the lower right corner of the control panel cabinet as illustrated below. It is secured to the PEM studs on the back wall of the cabinet with two supplied hex nuts.

IMPORTANT! When the BRKT-9600 is installed, the MS-9600 cabinet can hold a maximum of two 12 Amp Hour batteries with the orientation illustrated below.

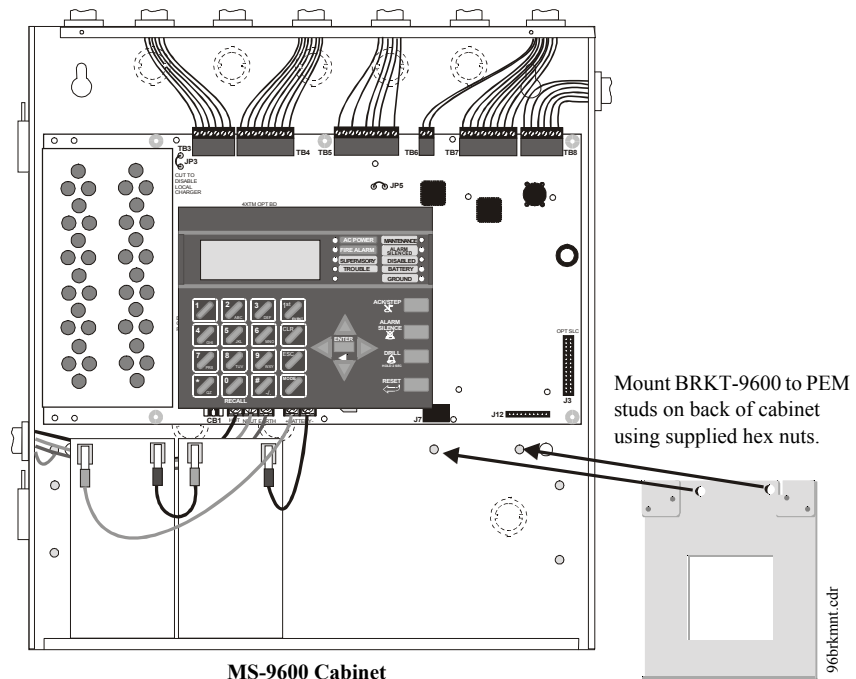

Figure 2.13 BRKT-9600 Bracket Installation

Module Installation on BRKT-9600

The following modules can be installed inside the MS-9600 cabinet using the BRKT-9600 Universal Bracket:

- ✓ UDACT-F Digital Alarm Communicator/Transmitter - installs at standoff location (A)
- ✓ ACM-8RF Annunciator Control Module (Relay) - installs at standoff location (A)

Refer to the appropriate module manual for detailed information on module operation and wiring.

1. Install the two supplied standoffs in location (A) as indicated in Step 1 of the following illustration
2. Position the module bottom in the slot located in the bottom of the BRKT-9600 as indicated in Step 2 of the following illustration
3. Secure the module to the standoffs installed in the top of the BRKT-9600 with two mounting screws as indicated in Step 3 of the following illustration
4. Refer to the appropriate module manual for detailed information on wiring the module for power, communication, etc.
5. Install a maximum of two 12 Amp Hour batteries with the orientation illustrated in Figure 2.13. Larger batteries require a separate UL listed battery box

Note: Do not bring wiring or conduit into the bottom of the cabinet for this application.

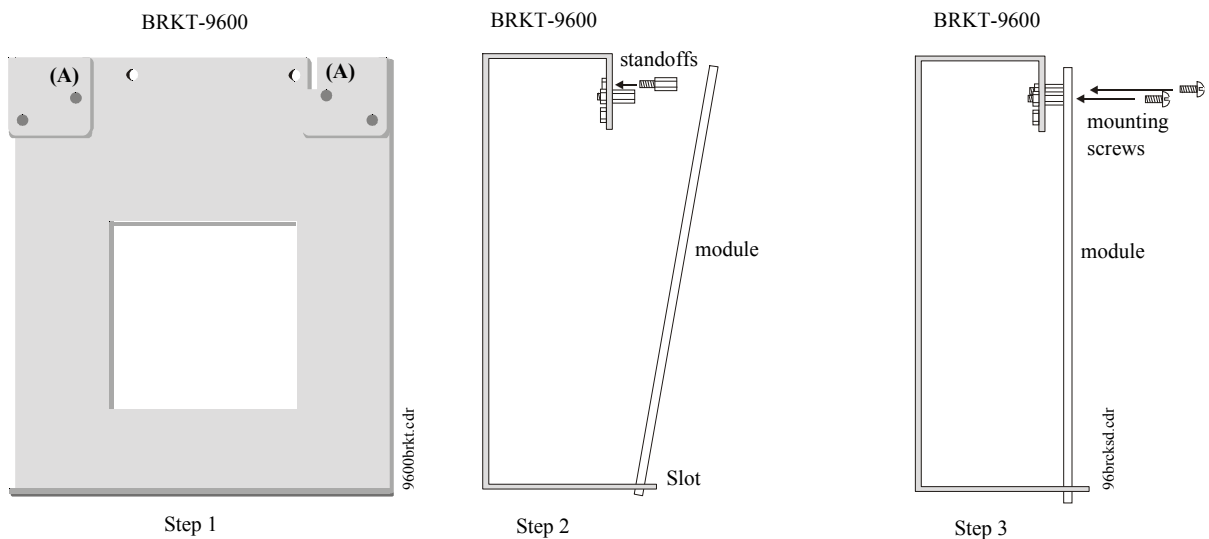

Figure 2.14 BRKT-9600 Module Installation Steps

2.6.5.4 ACM and AFM Series Annunciators

ACM and AFM Series Annunciators provide visual indications of FACP status in remote locations. Refer to the appropriate annunciator manual for information on installation, wiring and operation.

Annunciator addressing is specific to the MS-9600 control panel. The following table describes the annunciator addresses and the corresponding addressable devices that will be annunciated at each annunciator address.

ACM Annunciator Address	Annunciator Displays the Following Points
1	8 General System Status Points & Zones 1 - 56
2	Zones 57 - 99 & 2 NACs
3	Loop 1, Module Addresses 1 - 64
4	Loop 2, Module Addresses 1 - 64
5	Loop 1, Module Addresses 65 - 128
6	Loop 2, Module Addresses 65 - 128
7	Loop 1, Module Addresses 129 - 159 & Loop 2 Module Addresses 129 - 159
8	Loop 1, Detector Addresses 1 - 64
9	Loop 2, Detector Addresses 1 - 64
10	Loop 1, Detector Addresses 65 - 128
11	Loop 2, Detector Addresses 65 - 128
12	Loop 1 Detector Addresses 129 - 159 & Loop 2 Detector Addresses 129 - 159
13	not used
14	not used
15	not used
16	not used
17	not used
18	not used
19	not used
20	8 General System Status Points & Zones 1 - 56
21	Zones 57 - 99 & 2 NACs
22	Loop 1, Module Addresses 1 - 64
23	Loop 2, Module Addresses 1 - 64
24	Loop 1, Module Addresses 65 - 128
25	Loop 2, Module Addresses 65 - 128
26	Loop 1, Module Addresses 129 - 159 & Loop 2 Module Addresses 129 - 159
27	Loop 1, Detector Addresses 1 - 64
28	Loop 2, Detector Addresses 1 - 64
29	Loop 1, Detector Addresses 65 - 128
30	Loop 2, Detector Addresses 65 - 128
31	Loop 1 Detector Addresses 129 - 159 & Loop 2 Detector Addresses 129 - 159
32	not used

Important: If a UDACT-F is installed in the MS-9600 and selected in programming, the control panel will automatically assign annunciator addresses 20 - 31 to the UDACT-F and disable the selection of these addresses in programming for ACM annunciators. Do not set any ACM annunciators to these addresses.

The MS-9600 must be programmed for the annunciators installed on the system. Refer to "Annunciators/UDACT" on page 91 for information on UDACT-F and annunciator programming. Make certain to program the annunciator addresses that have been physically installed on the system.

Note: The 8 General System Status Points include the following:

- General Alarm
- General Trouble
- General Supervisory
- Alarm Silenced
- System Off Normal
- AC Loss
- Battery Fault
- NAC Fault

SECTION 3 Programming

3.1 Programming Data Entry

Programming can be accomplished using the MS-9600 keypad or by connecting an optional standard computer keyboard. The keyboard can be connected to the PS-2 connector J7 on the control panel main circuit board.

The information presented in this section refers to programming the MS-9600 via the onboard keypad. If an optional computer keyboard is connected to the MS-9600 main circuit board, the following table describes the keyboard keys which correspond to the onboard keypad keys.

Keypad Keys	Computer Keyboard Keys
1st Event	Home
CLR	Delete
ESC	Esc
RECALL	Insert
*	*
#	#
A - Z	A - Z
0 - 9	0 - 9
■ (on QZ key)	Space bar
—	—
/	/
•	•
←	←
→	→
↑	↑
↓	↓
ENTER	Enter

Note: The main keypad function keys (ACK/STEP, ALARM SILENCE, DRILL and RESET) are not available on the keyboard.

3.2 User Programming



The MS-9600 is completely field programmable and requires no special software skills. *While programming the MS-9600, the fire protection capabilities of the control panel are enabled.*

Site-specific programming may be accomplished in three ways:

- **Autoprogramming Feature** - This is a convenient method for quickly bringing the FACP addressable SLC devices on-line without the necessity of programming each device individually. Refer to "Autoprogram" on page 87 for a detailed description of Autoprogramming
- Manual programming or editing, using the FACP keypad or a PC keyboard
- Off-line Programming and Editing Feature - allows creation and editing of site-specific custom programs using a Windows-based computer. For programs requiring a large amount of data entry, this method may be preferred. A PK-9600 programming kit can be ordered for this purpose

The *System All Normal* screen will be displayed in a programmed system with no active alarms, troubles or supervisories, as illustrated below:



Programming and Read Status mode can be entered while the panel is in any mode of operation. If the panel is in alarm, the alarm condition must be acknowledged before entering any other mode. To access any of the programming or read status features, the *Enter* or *Mode* key must be pressed, which will cause the LCD to display the following:



Pressing *1*, while this screen is being displayed, will cause the control panel to enter the Read Status feature which allows the user to view the programmed features and status of the control panel. The Read Status feature is not password protected. Refer to "Read Status" on page 117 for a detailed description of this feature.



See Page

Pressing *2* will select user Programming which may only be accomplished by an authorized person. After pressing *2*, a screen will prompt for a password. After entering the correct password, the user may select from a list of programming options.

Exit Programming or Read Status

The programmer can exit Read Status or Programming mode by repeatedly pressing the keypad *ESC* (Escape) key until the display reads System All Normal. *Note that the data which is entered during Programming mode is not saved until the programmer exits this mode by repeatedly pressing the 'ESC' key. If the Reset key is pressed or power is lost before exiting Programming mode, all data which was just entered will be lost.*

User Programming Levels

There are two user programming levels:

- User Master Program Level 1 is used for programming panel specific data relating to device types, zoning, messages, control panel functions, etc.
- User Maintenance Program Level 2 is used by a qualified operator to access features such as Disable/Enable, View and Clear History, Walktest and System Time Change.

3.3 Initial Power-up

The following sections describe the initial programming procedures for a new system. The same procedures are used to modify programming in an existing system.

After completing the wiring of addressable devices to the SLC, apply power to the control panel. If the addressable devices have not yet been programmed into the FACP, their LEDs will not flash and the following trouble message will be displayed.



```

TROUBL IN SYSTEM
NO DEVICES INSTALLED
09:03A 010801

```

3.4 Programming Screens Description

Two main options are available when the *Enter* key is pressed: Read Status and Programming. Each option has multiple functions or features which may be chosen. To view all of the choices, it is necessary that the programmer scroll through a number of additional *subscreens*. These selections are displayed on multiple screens to make them more readable for the programmer. Refer to "Master Programming Level" on page 42, for additional information on the various screens.



The title of the main option screen will always be displayed at the top of the subscreens for the programmer's convenience. If additional subscreens exist, an Up or Down arrow will be displayed in the upper right corner of the screen being viewed. The programmer can then press the keypad Up or Down arrow key to view the new subscreen. To select one of the choices in a screen, the programmer presses the keypad numerical key corresponding to the desired choice.

Note that subscreens may also have multiple options which require viewing more than one screen. The same process, as detailed in the previous paragraphs, is followed to view all option choices.

3.5 Programming and Passwords

There are two factory set programming passwords which will access the Programming screens as indicated in the following examples. From either of the screens, access to specific system and device features or programming may be obtained. All user programming entries are stored in nonvolatile memory. The factory set passwords can be changed by the user as described in "Password Change" on page 93. If an invalid password is entered, the blinking cursor will return to the first password character position. To exit Programming or Read Status mode at any time, press the *ESC* (Escape) key repeatedly. Note that Programming mode must be exited using the *ESC* key in order to store the program data entered during this mode. If the *Reset* key is pressed or power is lost before exiting Programming mode, the data just entered will not be saved.



To access user Programming mode, press the *Enter* or *Mode* key. The LCD will display the following:



```
1=READ STATUS
2=PROGRAMMING
```

To enter the user Programming mode, press 2. The display will read as follows:



```
PROGRAMMING
ENTER PASSWORD
****
```

Entering the ***Master*** level password (default 0000) will cause the following screen to appear:



```
PROGRAMMING
1=POINT PROGRAM
2=ZONE SETUP
3=LOOP SETUP
```

If the ***Maintenance*** level password (default 1111) is entered, the following screen will appear:



```
PROGRAMMING
1=POINT PROGRAM
2=HISTORY
3=PROGRAM CHECK
```

Note that in the two preceding screens, an arrow appears to inform the programmer that additional options can be viewed by pressing the keypad *down* arrow key.

3.6 Master Programming Level

When the Master Program Level password is entered, the control panel will enter user Programming mode. In this mode, the piezo sounder remains off, the trouble relay is activated and the system Trouble LED flashes until Programming mode is exited. The following display will appear:



Programming Screen #1

The down arrow which appears in the display indicates that additional programming choices can be viewed by pressing the down arrow key on the keypad. If a down and up arrow appear in the display, pressing the 'down' arrow key will display the subsequent Programming Screens as illustrated below while pressing the 'up' arrow key will display the previous screen.



Programming Screen #2



Programming Screen #3



Programming Screen #4

3.6.1 Point Program

PROGRAMMING
1=POINT PROGRAM
2=ZONE SETUP
3=LOOP SETUP

Programming Screen #1

The Point Program option allows the programmer to add a new addressable device to an SLC loop, delete an existing device from a loop or change the programming for an existing device. Pressing *1*, while viewing Programming Screen #1, will select the Point Program option and display the following screen:

```

POINT PROGRAM
  SELECT LOOP
1=LOOP 1
2=LOOP 2

```

Point Program Screen #1

The programmer selects the desired SLC loop by pressing *1* or *2* in Point Program Screen #1, which causes the panel to display the following screen:

```

POINT PROGRAM
  SELECT TYPE
1=DETECTOR
2=MODULE

```

Point Program Screen #2

3.6.1.1 Detector Programming

Pressing *1*, while viewing Point Program Screen #2, will allow the programmer to add, delete or change the programming of an addressable detector. The following screen will be displayed by the control panel:

```

DETECTOR
1=ADD
2=DELETE
3=EDIT

```

Detector Screen

3.6.1.1.1 Add Detector

Pressing *1* while viewing the Detector Screen will display the following screen which allows the programmer to add a new detector address to programming:

```

ADD DETECTOR
ENTER DETECTOR#
***

```

Add Detector Screen

A flashing cursor will appear in the position of the first asterisk to the left. The programmer keys in the three digit detector address, such as 005.

When the last digit is keyed-in, the following screen will be displayed:

```

      ADD DETECTOR
DETECTOR#      005
IS ADDED
  
```

The programmer can continue adding detectors by pressing the *ESC* or left arrow key which will return the display to the Add Detector Screen.

3.6.1.1.2 Delete Detector

Pressing 2 in the Detector Screen will display the Delete Detector Screen which allows the programmer to delete a specific detector:

```

      DETECTOR
1=ADD
2=DELETE
3=EDIT
  
```

Detector Screen

```

      DELETE DETECTOR
ENTER DETECTOR#
***
  
```

Delete Detector Screen

A flashing cursor will appear in the position of the first asterisk to the left. The programmer keys in the three digit detector address, such as 005. When the last digit is keyed-in, the following screen will be displayed:

```

      DELETE DETECTOR
DETECTOR#      005
IS DELETED
  
```

The programmer can continue deleting detectors by pressing the *ESC* or left arrow key which will return the display to the Delete Detector Screen.

3.6.1.1.3 Edit Detector

The programmer can change a detectors existing or factory default programming by pressing 3 in the Detector Screen. The following screen will be displayed:

```

      EDIT DETECTOR
ENTER POINT ADDRESS
**
  
```

Edit Detector Screen

A flashing cursor will appear in the position of the first asterisk to the left. The programmer keys in the three digit detector address, such as 017.

When the last digit is keyed-in, if the selected address has not been added to programming, a screen showing information about a device with the *highest* address that is installed will be displayed.

If no detectors have been installed on the loop, the following will be displayed:

```

NO DETECTOR
INSTALLED
  
```

Edit Detector Screen #1

If the selected address has been added to programming, device summary screens will be displayed. These screens allow the programmer to view all device settings at a single glance. Pressing the left or right arrow keys will allow the programmer to rapidly view the devices at the previous or next address (if installed).

If a detector (such as a photoelectric detector) with the selected address is not physically installed on the SLC or has a communication fault but the address is programmed in the system, the following screen will be displayed:

```

TROUBL SMOKE<PHOTO>
*****
                ZNNN
                *  1D017
  
```

Edit Detector Screen #1

If the selected address has been added to programming and a detector (such as a photoelectric detector) with the selected address is physically installed on the SLC and is communicating with the control panel, the following will be displayed:

```

NORMAL SMOKE <PHOTO>
*****
                ZNNN
                U  1D017
  
```

Edit Detector Screen #1

To change the programming for the displayed detector, press the keyboard 'down' arrow key to view the Edit Detector screens.

In the preceding example:

- ✓ Normal - indicates that the detector with the selected address is physically installed on the SLC and communicating with the control panel (enabled)
- ✓ <ADJ><NOUN> - represents the adjective and noun, which have been programmed, describing the location of the displayed device
- ✓ ZNNN - represents the first of five possible software zones that the detector is assigned to (NNN = the three digit zone number from 000 - 099)
- ✓ V or * - indicates whether or not alarm verification is enabled (V = alarm verification enabled and * = alarm verification disabled)
- ✓ 1D017 - represents the Loop, Device type and Device address (1 = SLC Loop 1, D=Detector and 017 = Detector Address 017)

The following examples show the editing of a photoelectric smoke detector with address 017, located on the first SLC loop:

```

EDIT DETECTOR 1D017
1=ENABLED          YES
2=TYPE    SMOKE(PHOTO)
3=VERIFICATION    OFF
    
```

Edit Detector Screen #2

```

EDIT DETECTOR 1D017
1=WALKTEST        NO
2=PAS             NO
3=PRE-SIGNAL      NO
    
```

Edit Detector Screen #3

```

EDIT DETECTOR 1D017
1=ZONE ASSIGNMENT
  00 ** ** ** **
    
```

Edit Detector Screen #4

```

EDIT DETECTOR 1D017
1=NOUN/ADJECTIVE
2=DESCRIPTION
*****
    
```

Edit Detector Screen #5

```

EDIT DETECTOR
1=ENABLED
2=TYPE
3=VERIFICATION
    
```

Edit Detector Screen #2

Enable/Disable Detector

To Enable or Disable the detector, press the *I* key while viewing the Edit Detector Screen #2. Each press of the key will toggle the screen between *Enabled Yes* and *Enabled No*. If *Enabled No* is selected, the detector will not be polled by the control panel, preventing the detector from reporting alarms and troubles to the panel. The control panel will display the device type and address which has been disabled and will turn on the Trouble LED and Disable LED.

Type

EDIT DETECTOR
1=ENABLED
2=TYPE
3=VERIFICATION

Edit Detector Screen #2

To select the type of detector being programmed, press the 2 key while viewing the Edit Detector Screen #2. This will cause the control panel to display the following Detector Type Screens:

DETECTOR TYPE ↓
1=SMOKE (PHOTO)
2=SMOKE (ION)
3=HEAT

Detector Type Screen #1

DETECTOR TYPE ↑
1=SMOKE-DUCT-P
2=SUPERV DUCTP

Detector Type Screen #2

While viewing either Detector Type screen, select the type of detector being programmed by pressing the corresponding keyboard number key. The display will return to Edit Detector Screen #2 and indicate the selection next to the Type option.

Note: If a detector is selected to be a SUPERV DUCTP type, it will function like a supervisory point not a fire alarm point. The supervisory LED and supervisory relay will activate, not the fire alarm LED or alarm relay, if the detector senses smoke.

Verification

Alarm verification is used to confirm that a smoke detector activation is a true alarm condition and not a false alarm. This feature is selected by pressing 3 while viewing the Edit Detector Screen #2 so that the display reads *Verification On*. Each time the 3 key is pressed, the display will toggle between *Verification On* and *Verification Off*. For a detailed description, refer to "Alarm Verification (None or Two Minutes)" on page 116.



Walktest

The Walktest feature allows one person to test the system devices without the necessity of manually resetting the control panel after each device activation. To enable a device for the Walktest feature, press 1 while viewing the Edit Detector Screen #3 until the display reads *Walktest Yes*. Each press of the 1 key will cause the display to toggle between *Walktest Yes* and *Walktest No*. Refer to "Walktest" on page 116.

EDIT DETECTOR
1=WALKTEST
2=PAS
3=PRE-SIGNAL

Edit Detector Screen #3

PAS

The PAS (Positive Alarm Sequence) option will program the detector to delay panel activation (including alarm relay and communicator) for a period of 15 seconds plus a programmable time of up to 3 minutes. Zone 97, however, will activate immediately and may be used to connect a signaling device to indicate PAS activation (*do not use a Notification Appliance Circuit for this purpose*). To enable the PAS feature, press 2 while viewing the Edit Detector Screen #3 until the display reads *PAS Yes*. Each press of the 2 key will cause the display to toggle between *PAS Yes* and *PAS No*. Refer to "Positive Alarm Sequence" on page 114.



For example, if a detector with address 005 is to be configured for PAS operation:

- ✓ Select *PAS Yes* when editing the detector set to address 005
- ✓ Program the desired zone or zones to be activated by this detector, in this example Z001
- ✓ Program an output, such as a control module that is to be activated by detector 005 by assigning the same zone to it; in this example Z001
- ✓ Program an output, such as a control module, for PAS activation by assigning zone Z97 to it. This control module may be connected to a signaling device used to indicate a PAS condition (*do not use a Notification Appliance Circuit for this purpose*)
- ✓ Enable zones Z001 and Special Purpose Zone PAS 97 and set the PAS delay timer to some value

With the preceding program settings, when the detector with address 005 is activated, zone Z97 will cause its associated control module to activate immediately, sounding the connected PAS signaling device. Following the PAS delay time, zone Z001 will cause its associated control module to activate and the control panel will initiate an alarm condition.

Pre-signal

EDIT DETECTOR
1=WALKTEST
2=PAS
3=PRE-SIGNAL

Edit Detector Screen #3



The Pre-signal option programs the detector to delay panel activation for a preprogrammed time delay of up to three minutes while allowing for visual verification by a person. Note that the alarm relay and communicator will respond to the initial alarm immediately. In addition, Zone 98 will activate. This zone can be programmed to a control module which may be used to activate a sounder or indicator which the installer designates as a Presignal indication (*do not use a Notification Appliance Circuit for this purpose*). To enable the Pre-signal feature, press 3 while viewing Edit Detector Screen #3 until the display reads *Pre-signal Yes*. Each press of the 3 key will cause the display to toggle between *Pre-signal Yes* and *Pre-signal No*. Refer to "Presignal" on page 113.

For example, if a detector with address 005 is to be configured for Pre-Signal operation:

- ✓ Select *Pre-signal Yes* when editing the detector set to address 005
- ✓ Program the desired zone or zones to be activated by this detector, in this example Z001
- ✓ Program an output, such as a control module that is to be activated by detector 005 by assigning the same zone to it; in this example Z001
- ✓ Program an output, such as a control module, for Pre-signal activation by assigning zone Z98 to it. This control module may be connected to a signaling device used to indicate a Pre-signal condition (*do not use a Notification Appliance Circuit for this purpose*)
- ✓ Enable zones Z001 and Special Purpose Zone Pre-signal 98 and set the Pre-signal delay timer to some value

With the preceding program settings, when the detector with address 005 is activated, zone Z98 will cause its associated control module to activate immediately, sounding the connected signaling device to indicate the Pre-signal condition. Following the Pre-signal delay time, zone Z001 will cause its associated control module to activate and the control panel will initiate an alarm condition.

Zone Assignment

A maximum of five zones can be programmed to each addressable detector. Pressing *1* while viewing Edit Detector Screen #4 displays the following screen:

```

EDIT DETECTOR
1=ZONE ASSIGNMENT
00 ** ** ** **

```

Edit Detector Screen #4

```

ZONE ASSIGNMENT
Z00 Z** Z** Z** Z**

```

Zone Assignment Screen

Note that Z** represents the Zone Number(s) corresponding to this device. The factory default for an unprogrammed device is Z00 for general alarm zone. A flashing cursor will appear on the first 0 to the left. Enter the two digit number corresponding to the zone that is to be assigned to this device. The cursor moves to the next Z** designation. Continue entering zone assignments or the remaining zones can be left blank or programmed as general alarm zone Z00. When all desired changes have been made, press the Enter key to store the zone assignments. The display will return to the Edit Detector Screen #4. Note that the left and right arrow keys can be used to navigate through the zones and the CLEAR key can be used to quickly clear a zone.



Noun/Adjective

The Noun/Adjective selection allows the programmer to enter specific descriptors about the detector currently being programmed. Pressing *1* while viewing Edit Detector Screen #5 will cause the following screen to be displayed:

```

EDIT DETECTOR
1=NOUN/ADJECTIVE
2=DESCRIPTION
*****

```

Edit Detector Screen #5

```

1=STANDARD ADJECTIVE
2=STANDARD NOUN
3=CUSTOM ADJECTIVE
4=CUSTOM NOUN

```

Noun/Adjective Screen

```

1=STANDARD ADJECTIVE
2=STANDARD NOUN
3=CUSTOM ADJECTIVE
4=CUSTOM NOUN

```

Noun/Adjective Screen

Pressing 1 while viewing the Noun/Adjective Screen will cause the following screen(s) to be displayed. Note that the keyboard *down* arrow key must be pressed to see all the Adjective screens. Press the number corresponding to the adjective that is to be used as a descriptor for the location of the detector currently being programmed. When an adjective has been selected, it will appear at the top of the display as indicated by the asterisks.

```

*****
1=NORTH
2=SOUTH
3=EAST

```

Adjective Screen #1

```

*****
1=3RD
2=4TH
3=5TH

```

Adjective Screen #5

```

*****
1=WEST
2=FRONT
3=CENTER

```

Adjective Screen #2

```

*****
1=FLOOR1
2=FLOOR2
3=FLOOR3

```

Adjective Screen #6

```

*****
1=REAR
2=UPPER
3=LOWER

```

Adjective Screen #3

```

*****
1=FLOOR4
2=FLOOR5
3=ROOM

```

Adjective Screen #7

```

*****
1=MAIN
2=FIRST
3=2ND

```

Adjective Screen #4

```

1=STANDARD ADJECTIVE
2=STANDARD NOUN
3=CUSTOM ADJECTIVE
4=CUSTOM NOUN

```

Noun/Adjective Screen

Pressing 2 while viewing the Noun/Adjective Screen will cause the following screen(s) to be displayed. Note that the keyboard *down* arrow key must be pressed to see all the Noun screens. Press the number corresponding to the noun that is to be used as a descriptor for the location of the detector currently being programmed. When a noun has been selected, it will appear at the top of the display as indicated by the asterisks.

```

*****
1=BASEMENT
2=BOILER RM
3=CLASSROOM

```

Noun Screen #1

```

*****
1=KITCHEN
2=LOBBY
3=OFFICE

```

Noun Screen #5

```

*****
1=CLOSET
2=CORRIDOR
3=ELECTRIC RM

```

Noun Screen #2

```

*****
1=PATIENT
2=RESTROOM
3=ROOM

```

Noun Screen #6

```

*****
1=ELEVATOR
2=ENTRANCE
3=FLOOR

```

Noun Screen #3

```

*****
1=STAIRWAY
2=STOREROOM
3=WING

```

Noun Screen #7

```

*****
1=GARAGE
2=HALLWAY
3=HVAC RM

```

Noun Screen #4

```

1=STANDARD ADJECTIVE
2=STANDARD NOUN
3=CUSTOM ADJECTIVE
4=CUSTOM NOUN
    
```

Noun/Adjective Screen

```

EDIT DETECTOR
1=NOUN/ADJECTIVE
2=DESCRIPTION
    
```

Edit Detector Screen #5

Pressing 3 or 4 while viewing the Noun/Adjective Screen will display screens similar to the previous Adjective and Noun Screens. The new screens will list custom Adjectives and Nouns which have been programmed into the control panel using the PK-9600 programming kit. These descriptors are selected as described in the previous sections.

Description

The Description selection allows the programmer to enter additional information about the detector currently being programmed. This information will be displayed as part of the device label on the display. Pressing 2 while viewing Edit Detector Screen #5 will cause the following screen to be displayed:

```

DESCRIPTION      1D002
1=NOUN/ADJECTIVE

*****
    
```

Adjective/Noun Screen

A flashing cursor will appear at the first asterisk to the left. The programmer can enter additional descriptive information about the device being programmed. This information will appear on the display along with the standard device label information.

A maximum of 20 characters (including spaces) can be entered. To enter alphanumeric characters from the keypad, repeatedly press the appropriate key until the desired character is displayed in the first position. For example, to enter the letter *B*, press the 2 (ABC) key three times to toggle through the characters *I*, *A* and *B*. Press the right arrow key to move the cursor one position to the right and repeat the process to enter the next character. To enter a space, press the * (QZ) key four times until a blank appears in the desired position. When all characters have been entered, press the Enter key to store the information. The display will return to the Edit Detector Screen #5, displaying the new information at the bottom of the screen.

Recall/Increment Function

In addition, the user may use the Recall/Increment function at any time when the cursor is on the first letter of the Description, Adjective or Noun field as follows:

- If the zero key is pressed, a 0 is placed in the first letter position
- If the zero key is then pressed a second time with no intervening key actions, the entire field is replaced with the field entered *for the previous device programmed*, and the cursor moves to the last character of the field (Recall function). The Recalled Adjective or Noun field may now be changed letter-by-letter
- If the zero key is pressed again with no other intervening key actions and the last character in the field is a number 0-9, the number is incremented by one. If the last character is a letter, it changes to a 0. If the last character goes from 9 to 0 and the characters to the left of the last character are also numbers, they are also incremented (overflow)
- The above increment function may be repeated with each press of the zero key

As an example, the user could quickly enter 'FLR_3_ROOM_305' as follows:

1. The cursor is on the first letter of the Adjective field. Press the zero key twice to display *FLR_3*
2. With the cursor on the first letter of the Noun field, press the zero key twice to recall the display *ROOM_304*. The cursor automatically jumps from the first to the last letter of the Noun field
3. With the cursor on the last letter of the Noun field, press the zero key again to increment the room number to *305*
4. Press the right arrow key to advance the zone field
5. Select a zone number from 00 to 99. Z00 (default zone) is the general alarm zone. Z01 through Z99 may be selected to link software zones

3.6.1.2 Module Programming

Pressing 2, while viewing Point Program Screen #2, will allow the programmer to add, delete or change the programming of an addressable module. The following screen will be displayed by the control panel:



Point Program Screen #2

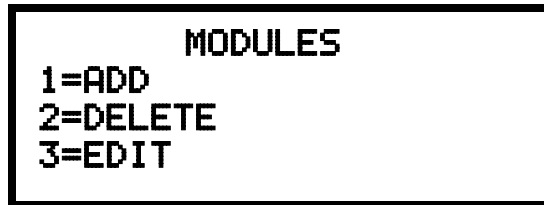

Modules Screen

3.6.1.2.1 Add Module

Pressing 1 while viewing the Modules Screen will display the following screen which allows the programmer to add a new module address to programming:

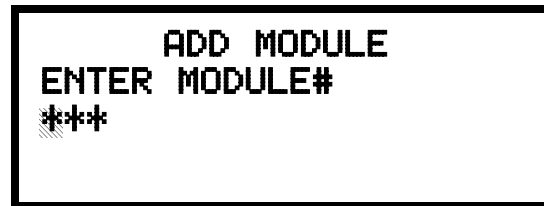

Add Module Screen #1

A flashing cursor will appear in the position of the first asterisk to the left. The programmer keys in the three digit module address, such as *005*.

When the last digit is keyed-in, the following screen will be displayed:

```

      ADD MODULE
    1=CONTROL
    2=MONITOR
  
```

Add Module Screen #2

Pressing 1 for Control Module or 2 for Monitor Module will cause the following screen to be displayed:

```

      ADD MODULE
    MODULE#           005
    IS ADDED
  
```

Add Module Screen #3

The programmer can continue adding modules by pressing the *ESC* or left arrow key which will return the display to the Add Module Screen #1.

3.6.1.2.2 Delete Module

Pressing 2 in the Modules Screen will display the Delete Module Screen which allows the programmer to delete a specific module:

```

    MODULES
    1=ADD
    2=DELETE
    3=EDIT
  
```

Modules Screen

```

      DELETE MODULE
    ENTER MODULE#
    ***
  
```

Delete Module Screen

A flashing cursor will appear in the position of the first asterisk to the left. Using the panel keypad, key in the module address such as 005. When the last digit is keyed in, the following confirmation that the module has been deleted will be displayed:

```

      DELETE MODULE
    MODULE#           005
    IS DELETED
  
```

3.6.1.2.3 Edit Module Screen for Monitor Module

The programmer can change a modules existing or factory default programming by pressing 3 in the Modules Screen. The following screen will be displayed:

```

EDIT MODULE
ENTER MODULE ADDRESS
***
  
```

Edit Module Screen

A flashing cursor will appear in the position of the first asterisk to the left. The programmer keys in the three digit module address, such as 012. When the last digit is keyed-in, if the selected address has not been added to programming, a screen showing information about the highest address that is installed will be displayed. If no modules are installed on the loop, the following screen will be displayed:

```

NO MODULE
INSTALLED
  
```

Edit Module Screen

If the selected address has been added to programming but a module (such as a monitor module) with the selected address is not physically installed on the SLC or has a communication fault, the following screen will be displayed:

```

TROUBL MONITOR
<ADJ> <NOUN>
      ZNNN
      1M012
  
```

If the selected address has been added to programming and a module (such as a monitor module) with the selected address is physically installed on the SLC and is communicating with the control panel, the following screen will be displayed:

```

NORMAL MONITOR
<ADJ> <NOUN>
      ZNNN
      1M012
  
```

To change the programming for the displayed module, press the keyboard down arrow key to view the following Edit Monitor screens. In the preceding example:

- ✓ Normal - indicates that the module with the selected address is physically installed on the SLC and communicating with the control panel (enabled)
- ✓ <ADJ><NOUN> - represents the adjective and noun, which have been programmed, describing the location of the displayed device
- ✓ ZNNN - represents the first of five possible software zones that the module is assigned to (NNN = the two digit zone number from 000 - 099)
- ✓ 1M012 - represents the Loop, Device type and Device address (1 = SLC Loop 1, M=Module and 012 = Module Address 012)



If the selected address corresponds to a control module, a screen displaying information about the control module with the selected address will be displayed as shown in "Edit Module Screen for Control Modules" on page 63.

If the selected address corresponds to a monitor module, a screen displaying information about the module with the selected address will be displayed as illustrated in the following:

```

NORMAL MONITOR      ↓
      <ADJ> <NOUN>
                        ZNNN
                        1M012
    
```

```

EDIT MONITOR  1M012  ↑↓
1=ENABLED      YES
2=TYPE  MONITOR
    
```

Edit Monitor Screen #2

```

EDIT MONITOR  1M012  ↑↓
1=PRE-SIGNAL   NO
2=PAS         NO
    
```

Edit Monitor Screen #3

```

EDIT MONITOR  1M012  ↑↓
1=WALKTEST     YES
2=ZONE ASSIGNMENT
      00 ** ** ** **
    
```

Edit Monitor Screen #4

```

EDIT MONITOR  1M012  ↑
1=ADJECTIVE/NOUN
2=DESCRIPTION
*****
    
```

Edit Monitor Screen #5

Enable/Disable Module

To Enable or Disable the monitor module, press the 1 key while viewing the Edit Module Screen #2. Each press of the key will toggle the screen between *Enabled Yes* and *Enabled No*. If *Enabled No* is selected, the module will not be polled by the control panel, preventing the module from reporting alarms and troubles to the panel. The control panel will indicate a system trouble condition and the Disable LED with turn on if any devices are disabled.

```

EDIT MONITOR
1=ENABLED
2=TYPE MONITOR
    
```

Edit Monitor Screen #2

Type Monitor

Using the PK-9600 Upload/Download utility program, unique user-defined monitor types can be created and loaded into the FACP for later use. The FACP response to the activation of a user-defined type is the same as most previous standard types in the list, thus allowing a variety of user-defined types and responses. To select the type of monitor module being programmed, press the 2 key while viewing the Edit Monitor Screen #2. This will cause the control panel to display the following Monitor Type Screens:

```

MONITOR TYPE
1=PULL-STATION
2=USER-DEFINED-1
3=WATERFLOW
    
```

Monitor Type Screen #1

```

MONITOR TYPE
1=USER-DEFINED-6
2=MEDIC-ALERT
3=USER-DEFINED-7
    
```

Monitor Type Screen #5

```

MONITOR TYPE
1=USER-DEFINED-2
2=MONITOR
3=BLANK
    
```

Monitor Type Screen #2

```

MONITOR TYPE
1=HAZARD-ALERT
2=USER-DEFINED-8
3=TORNADO-ALERT
    
```

Monitor Type Screen #6

```

MONITOR TYPE
1=USER-DEFINED-3
2=FUTURE USE
3=USER-DEFINED-4
    
```

Monitor Type Screen #3

```

MONITOR TYPE
1=USER-DEFINED-9
2=USER-DEFINED-10
3=USER-DEFINED-11
    
```

Monitor Type Screen #7

```

MONITOR TYPE
1=SMOKE-CONVENTIONAL
2=HEAT-DETECTOR
3=USER-DEFINED-5
    
```

Monitor Type Screen #4

```

MONITOR TYPE
1=TAMPER
2=SUPERVISORY
3=SUPERVISORY-AR
    
```

Monitor Type Screen #8

Note: For the SUPERVISORY-AR selection, AR refers to AutoResettable

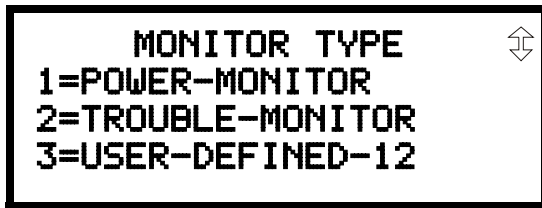

Monitor Type Screen #9

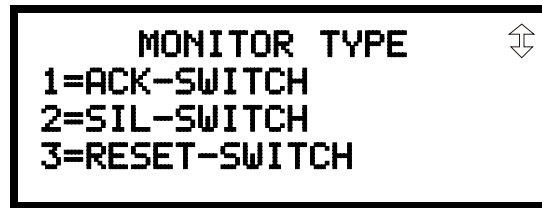

Monitor Type Screen #11

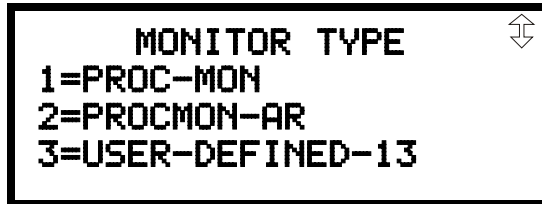

Monitor Type Screen #10

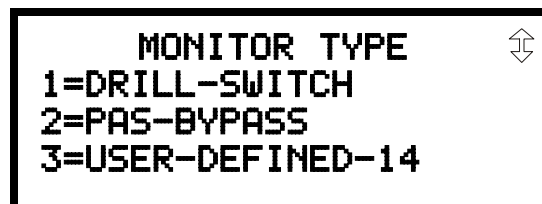

Monitor Type Screen #12

Note: For the PROCMON-AR selection, PROCMON refers to Process Monitor and AR refers to AutoResettable

While viewing one of the Monitor Type screens, select the type of monitor module being programmed by pressing the corresponding keypad number key. The display will return to the Edit Monitor Screen #2 which will show the new type selection.

Monitor module type selection will affect the function of the point as follows:

Monitor Type	Action When Activated
Pull-Station	Fire Alarm
User-Defined-1	Fire Alarm
Waterflow	Fire Alarm Delayed
User-Defined-2	Fire Alarm Delayed
Monitor	Fire Alarm
Blank	Fire Alarm
User-Defined-3	Fire Alarm
Future Use	Future Use
User-Defined-4	Supervisory on partial short, Fire Alarm on full short
Smoke-Conventional	Fire Alarm
Heat-Detector	Fire Alarm
User-Defined-5	Fire Alarm
User-Defined-6	Fire Alarm
Medic-Alert	Supervisory, latching
User-Defined-7	Supervisory, latching
Hazard-Alert	Supervisory, latching
User-Defined-8	Supervisory, latching
Tornado-Alert	Supervisory, latching
User-Defined-9	Supervisory, latching
User-Defined-10	Supervisory, latching
User-Defined-11	Supervisory, latching
Tamper	Supervisory, nonlatching (tracking)
Supervisory	Supervisory, latching
Supervisory-AR	Supervisory, nonlatching (tracking)
Power-Monitor	AC Fault
Trouble-Monitor	Trouble
User-Defined-12	Trouble
Proc-Mon	Piezo
Procmon-Auto	Piezo, nonlatching (tracking)
User-Defined-13	Piezo, nonlatching (tracking)
Ack-Switch	Acts like panel Acknowledge Key
Sil-Switch	Acts like panel Alarm Silence Key
Reset-Switch	Acts like panel Reset Key
Drill-Switch	Acts like panel Drill Key
PAS-Bypass	PAS Disable
User-Defined-14	PAS Disable

```

EDIT MONITOR
1=PRE-SIGNAL
2=PAS

```

Edit Monitor Screen #3



```

EDIT MONITOR
1=WALKTEST
2=ZONE ASSIGNMENT
00 ** ** ** **

```

Edit Monitor Screen #4

```

EDIT MONITOR
1=NOUN/ADJECTIVE
2=DESCRIPTION
*****

```

Edit Monitor Screen #5

Pre-signal

To enable the Pre-signal feature, press 1 while viewing Edit Monitor Screen #3 until the display reads *Pre-signal Yes*. Each press of the 1 key will cause the display to toggle between *Pre-signal Yes* and *Pre-signal No*. Refer to "Presignal" on page 113 for additional information.

PAS

To enable the PAS feature, press 2 while viewing the Edit Detector Screen #3 until the display reads *PAS Yes*. Each press of the 2 key will cause the display to toggle between *PAS Yes* and *PAS No*. Refer to "Positive Alarm Sequence" on page 114 for additional information.

Walktest

The Walktest feature allows one person to test the system devices without the necessity of manually resetting the control panel after each device activation. To enable devices, which are connected to a monitor module, for the Walktest feature, press 1 while viewing the Edit Monitor Screen #4 until the display reads *Walktest Yes*. Each press of the 1 key will cause the display to toggle between *Walktest Yes* and *Walktest No*. Refer to "Walktest" on page 116 for additional information.

Zone Assignment

A maximum of five zones can be programmed to each addressable monitor module. Pressing 2 while viewing Edit Monitor Screen #4 displays the following screen:

```

MON ZONE ASSIGN
Z00 Z** Z** Z** Z**

```

Zone Assignment Screen

Note that Z** represents the Zone Number(s) corresponding to this device. The factory default for an unprogrammed device is Z00 for general alarm zone. A flashing cursor will appear on the first 0 to the left. Enter the two digit number corresponding to the zone that is to be assigned to this device. The cursor moves to the next Z** designation. Continue entering zone assignments or the remaining zones can be left blank or programmed as general alarm zones Z00. When all desired changes have been made, press the Enter key to store the zone assignments. The display will return to the Edit Monitor Screen #4.

Noun/Adjective

The Noun/Adjective selection allows the programmer to enter specific descriptors about the monitor module currently being programmed. Pressing 1 while viewing Edit Monitor Screen #5 will cause the following screen to be displayed:

```

1=STANDARD ADJECTIVE
2=STANDARD NOUN
3=CUSTOM ADJECTIVE
4=CUSTOM NOUN

```

Noun/Adjective Screen

```

1=STANDARD ADJECTIVE
2=STANDARD NOUN
3=CUSTOM ADJECTIVE
4=CUSTOM NOUN

```

Noun/Adjective Screen

Pressing 1 while viewing the Noun/Adjective Screen will cause the following screen(s) to be displayed. Note that the keyboard *down* arrow key must be pressed to see all the Adjective screens. Press the number corresponding to the adjective that is to be used as a descriptor for the location of the monitor module currently being programmed.

```

*****
1=NORTH
2=SOUTH
3=EAST

```

Adjective Screen #1

```

*****
1=3RD
2=4TH
3=5TH

```

Adjective Screen #5

```

*****
1=WEST
2=FRONT
3=CENTER

```

Adjective Screen #2

```

*****
1=FLOOR 1
2=FLOOR 2
3=FLOOR 3

```

Adjective Screen #6

```

*****
1=REAR
2=UPPER
3=LOWER

```

Adjective Screen #3

```

*****
1=FLOOR 4
2=FLOOR 5
3=ROOM

```

Adjective Screen #7

```

*****
1=MAIN
2=FIRST
3=2ND

```

Adjective Screen #4

```

1=STANDARD ADJECTIVE
2=STANDARD NOUN
3=CUSTOM ADJECTIVE
4=CUSTOM NOUN

```

Noun/Adjective Screen

Pressing 2 while viewing the Noun/Adjective Screen will cause the following screen(s) to be displayed. Note that the keyboard *down* arrow key must be pressed to see all the Noun screens. Press the number corresponding to the noun that is to be used as a descriptor for the location of the monitor module currently being programmed.

```

*****
1=BASEMENT
2=BOILER RM
3=CLASSROOM

```

Noun Screen #1

```

*****
1=KITCHEN
2=LOBBY
3=OFFICE

```

Noun Screen #5

```

*****
1=CLOSET
2=CORRIDOR
3=ELECTRIC RM

```

Noun Screen #2

```

*****
1=PATIENT
2=RESTROOM
3=ROOM

```

Noun Screen #6

```

*****
1=ELEVATOR
2=ENTRANCE
3=FLOOR

```

Noun Screen #3

```

*****
1=STAIRWAY
2=STOREROOM
3=WING

```

Noun Screen #7

```

*****
1=GARAGE
2=HALLWAY
3=HVAC RM

```

Noun Screen #4

Pressing 3 or 4 while viewing the Noun/Adjective Screen will display screens similar to the previous Adjective and Noun Screens. The new screens will list Custom Adjectives and Nouns which have been programmed into the control panel using the PK-9600 programming kit.

```

EDIT MONITOR
1=NOUN/ADJECTIVE
2=DESCRIPTION
*****
Edit Monitor Screen #5

```

Description

The Description selection allows the programmer to enter additional information about the monitor module currently being programmed. This information will be displayed as part of the device label on the LCD display. Pressing 2 while viewing Edit Monitor Screen #5 will cause the following screen to be displayed:

```

DESCRIPTION      1M012
1=NOUN/ADJECTIVE
*****

```

Noun/Adjective Screen

A flashing cursor will appear at the first asterisk to the left. The programmer can enter additional descriptive information about the device being programmed. This information will appear on the LCD display along with the standard device label information.

A maximum of 20 characters (including spaces) can be entered. To enter alphanumeric characters from the keypad, repeatedly press the appropriate key until the desired character is displayed in the first position. For example, to enter the letter *B*, press the 2 (*ABC*) key three times to toggle through the characters 2, *A* and *B*. Press the right arrow key to move the cursor one position to the right and repeat the process to enter the next character. To enter a space, press the * (*QZ*) key four times until a blank appears in the desired position. When all characters have been entered, press the Enter key to store the information. The display will return to the Edit Monitor Screen #4, displaying the new information at the bottom of the screen.

Recall/Increment Function

In addition, the user may use the Recall/Increment function at any time when the cursor is on the first letter of the Adjective or Noun field as follows:

- If the zero key is pressed, a 0 is placed in the first letter position
- If the zero key is then pressed a second time with no intervening key actions, the entire Adjective field is replaced with the field entered for the previous device programmed, and the cursor moves to the last character of the field (Recall function). The Recalled Adjective or Noun field may now be changed letter-by-letter
- If the zero key is pressed again with no other intervening key actions and the last character in the field is a number 0-9, the number is incremented by one. If the last character is a letter, it changes to a 0. If the last character goes from 9 to 0 and the characters to the left of the last character are also numbers, they are also incremented (overflow)
- The above increment function may be repeated with each press of the zero key

As an example, the user could quickly enter 'FLR_3_ROOM 305' as follows:

1. The cursor is on the first letter of the Adjective field. Press the zero key twice to display *FLR_3*
2. With the cursor on the first letter of the Noun field, press the zero key twice to recall the display *ROOM_304*. The cursor automatically jumps from the first to the last letter of the Noun field
3. With the cursor on the last letter of the Noun field, press the zero key again to increment the room number to *305*
4. Press the right arrow key to advance the zone field
5. Select a zone number from 00 to 99. Z00 (default zone) is the general alarm zone. Z01 through Z99 may be selected to link software zones

3.6.1.2.4 Edit Module Screen for Control Modules

The programmer can change a module's existing or factory default programming by pressing 3 in the Modules Screen. The following screen will be displayed:



Modules Screen

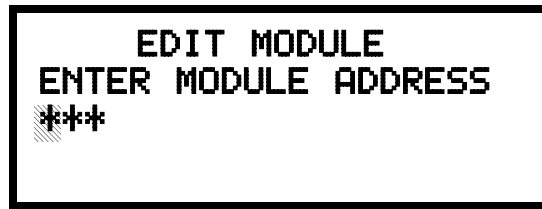

Edit Module Screen

A flashing cursor will appear in the position of the first asterisk to the left.

The programmer keys in the three digit module address, such as *002*. When the last digit is keyed-in, if the selected address corresponds to a *control* module, a screen displaying information about the control module with the selected address will be displayed as illustrated in the following:



Edit Control Screen #1

In the preceding example:

- ✓ Normal - indicates that the module with the selected address is physically installed on the SLC and communicating with the control panel (enabled)
- ✓ <ADJ><NOUN> - represents the adjective and noun, which have been programmed, describing the location of the displayed device
- ✓ Control - indicates that the selected module is a control module
- ✓ S or * - represents Silenceable (S) or Nonsilenceable (*)
- ✓ W or * - represents Waterflow Timer Delay (W = Waterflow Timer Delay enabled, * = Waterflow Timer Delay disabled)
- ✓ ZNNN - represents the first of five possible software zones that the module is assigned to (NNN = the three digit zone number from 000 - 099)
- ✓ 1M002 - represents the Loop, Device type and Device address (1 = SLC Loop 1, M=Module and 002 = Module Address 02)

To change the programming for the displayed module, press the keyboard *down* arrow key to view the following Edit Control screens:



Edit Control Screen #2

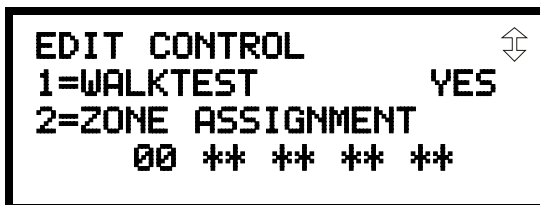

Edit Control Screen #3



Edit Control Screen #4

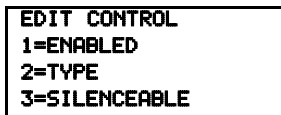

Edit Control Screen #2

Enable/Disable Module

To Enable or Disable the control module, press the *1* key while viewing the Edit Control Screen #2. Each press of the key will toggle the screen between *Enabled Yes* and *Enabled No*. If *Enabled No* is selected, the module will not be polled by the control panel, preventing the module from activating its output devices. The control panel will indicate a system trouble condition and the Disable LED will turn on if any devices are disabled.

Type

To select the type of control module being programmed, press the 2 key while viewing the Edit Control Screen #2. This will cause the control panel to display the following Control Type Screens:

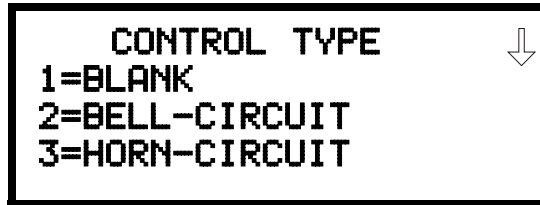

Control Type Screen #1

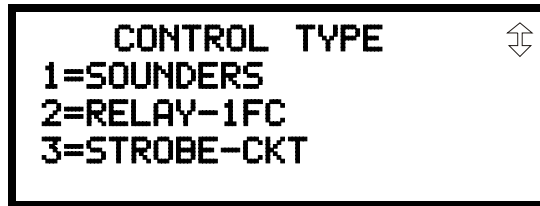

Control Type Screen #2



Control Type Screen #3

While viewing one of the Control Type screens, select the type of control module being programmed by pressing the corresponding keypad number key. The display will return to the Edit Control Screen #2 and indicate the new type selection.

The following table contains control module type codes and their functions:

Control Type	Special Function
Blank	None
Bell Circuit	None
Horn Circuit	None
Sounders	None
Relay	Ignore Open Circuit
Strobe Circuit	None
Control	None

Silenceable

The Silenceable selection allows the programmer to select whether output devices connected to the control module can be silenced, either by pressing the Alarm Silence key or by enabling Autosilence. Pressing the 3 key while viewing Edit Control Screen #2 will enable the Silenceable feature causing the display to read *Silenceable Yes*. Repeated presses of the 3 key will cause the display to toggle between *Silenceable Yes* and *Silenceable No*.

```

EDIT CONTROL
1=WALKTEST
2=ZONE ASSIGNMENT
  00 ** ** ** **

```

Edit Control Screen #3

Walktest

The Walktest feature allows one person to test the system devices without the necessity of manually resetting the control panel after each device activation. To enable devices, which are connected to a control module, for the Walktest feature, press *1* while viewing the Edit Control Screen #3 until the display reads *Walktest Yes*. Each press of the *1* key will cause the display to toggle between *Walktest Yes* and *Walktest No*. Refer to "Walktest" on page 116 for additional information.

Zone Assignment

A maximum of five zones can be programmed to each addressable control module. Pressing *2* while viewing Edit Control Screen #3 displays the following screen:

```

ZONE ASSIGNMENT
Z00 Z** Z** Z** Z**

```

Zone Assignment Screen

Note that *Z*** represents the Zone Number(s) corresponding to this device. The factory default for an unprogrammed device is *Z00* for general alarm zone. A flashing cursor will appear on the first *0* to the left. Enter the two digit number corresponding to the zone that is to be assigned to this device. The cursor moves to the next *Z*** designation. Continue entering zone assignments or the remaining zones can be left blank or programmed as general alarm zones *Z00*. When all desired changes have been made, press the Enter key to store the zone assignments. The display will return to the Edit Control Screen #3.

```

EDIT CONTROL
1=NOUN/ADJECTIVE
2=DESCRIPTION

```

Edit Control Screen #4

Noun/Adjective

The Noun/Adjective selection allows the programmer to enter specific descriptors about the control module currently being programmed. Pressing *1* while viewing Edit Control Screen #4 will cause the following screen to be displayed:

```

1=STANDARD ADJECTIVE
2=STANDARD NOUN
3=CUSTOM ADJECTIVE
4=CUSTOM NOUN

```

Noun/Adjective Screen

```

1=STANDARD ADJECTIVE
2=STANDARD NOUN
3=CUSTOM ADJECTIVE
4=CUSTOM NOUN

```

Noun/Adjective Screen

Pressing 1 while viewing the Noun/Adjective Screen will cause the following screen(s) to be displayed. Note that the keyboard *down* arrow key must be pressed to see all the Adjective screens. Press the number corresponding to the adjective that is to be used as a descriptor for the location of the control module currently being programmed.

```

*****
1=NORTH
2=SOUTH
3=EAST

```

Adjective Screen #1

```

*****
1=3RD
2=4TH
3=5TH

```

Adjective Screen #5

```

*****
1=WEST
2=FRONT
3=CENTER

```

Adjective Screen #2

```

*****
1=FLOOR 1
2=FLOOR 2
3=FLOOR 3

```

Adjective Screen #6

```

*****
1=REAR
2=UPPER
3=LOWER

```

Adjective Screen #3

```

*****
1=FLOOR 4
2=FLOOR 5
3=ROOM

```

Adjective Screen #7

```

*****
1=MAIN
2=FIRST
3=2ND

```

Adjective Screen #4

```

1=STANDARD ADJECTIVE
2=STANDARD NOUN
3=CUSTOM ADJECTIVE
4=CUSTOM NOUN

```

Noun/Adjective Screen

Pressing 2 while viewing the Noun/Adjective Screen will cause the following screen(s) to be displayed. Note that the keyboard *down* arrow key must be pressed to see all the Noun screens. Press the number corresponding to the noun that is to be used as a descriptor for the location of the control module currently being programmed.

```

*****
1=BASEMENT
2=BOILER RM
3=CLASSROOM

```

Noun Screen #1

```

*****
1=KITCHEN
2=LOBBY
3=OFFICE

```

Noun Screen #5

```

*****
1=CLOSET
2=CORRIDOR
3=ELECTRIC RM

```

Noun Screen #2

```

*****
1=PATIENT
2=RESTROOM
3=ROOM

```

Noun Screen #6

```

*****
1=ELEVATOR
2=ENTRANCE
3=FLOOR

```

Noun Screen #3

```

*****
1=STAIRWAY
2=STOREROOM
3=WING

```

Noun Screen #7

```

*****
1=GARAGE
2=HALLWAY
3=HVAC RM

```

Noun Screen #4

Pressing 3 or 4 while viewing the Noun/Adjective Screen will display screens similar to the previous Adjective and Noun Screens. The new screens will list Custom Adjectives and Nouns which have been programmed into the control panel using the PK-9600 programming kit.

```

EDIT CONTROL
1=ADJECTIVE/NOUN
2=DESCRIPTION

```

Edit Control Screen #4

Description

The Description selection allows the programmer to enter additional information about the control module currently being programmed. This information will be displayed as part of the device label on the display. Pressing 2 while viewing Edit Control Screen #4 will cause the following screen to be displayed:

```

DESCRIPTION      1M002
1=NOUN/ADJECTIVE

*****

```

Adjective/Noun Screen

A flashing cursor will appear at the first asterisk to the left. The programmer can enter additional descriptive information about the device being programmed. This information will appear on the display along with the standard device label information.

A maximum of 20 characters (including spaces) can be entered. To enter alphanumeric characters from the keypad, repeatedly press the appropriate key until the desired character is displayed in the first position. For example, to enter the letter *B*, press the 2 (*ABC*) key three times to toggle through the characters *I*, *A* and *B*. Press the right arrow key to move the cursor one position to the right and repeat the process to enter the next character. To enter a space, press the * (*QZ*) key four times until a blank appears in the desired position. When all characters have been entered, press the Enter key to store the information. The display will return to the Edit Control Screen #4, displaying the new information at the bottom of the screen.

Recall/Increment Function

In addition, the user may use the Recall/Increment function at any time when the cursor is on the first letter of the Adjective or Noun field as follows:

- If the zero key is pressed, a 0 is placed in the first letter position
- If the zero key is then pressed a second time with no intervening key actions, the entire Adjective field is replaced with the field entered for the previous device programmed, and the cursor moves to the last character of the field (Recall function). The Recalled Adjective or Noun field may now be changed letter-by-letter
- If the zero key is pressed again with no other intervening key actions and the last character in the field is a number 0-9, the number is incremented by one. If the last character is a letter, it changes to a 0. If the last character goes from 9 to 0 and the characters to the left of the last character are also numbers, they are also incremented (overflow)
- The above increment function may be repeated with each press of the zero key

As an example, the user could quickly enter 'FLR_3_ROOM 305' as follows:

1. The cursor is on the first letter of the Adjective field. Press the zero key twice to display *FLR_3*
2. With the cursor on the first letter of the Noun field, press the zero key twice to recall the display *ROOM_304*. The cursor automatically jumps from the first to the last letter of the Noun field
3. With the cursor on the last letter of the Noun field, press the zero key again to increment the room number to *305*
4. Press the right arrow key to advance the zone field
5. Select a zone number from 00 to 99. Z00 (default zone) is the general alarm zone. Z01 through Z99 may be selected to link software zones

3.6.2 Zone Setup

PROGRAMMING
1=POINT
2=ZONE SETUP
3=LOOP SETUP

Programming Screen #2

Pressing 2 while viewing Programming Screen #2 will access the Zone Setup screens as illustrated below:

ZONE SETUP ↓
1=ENABLE
2=DISABLE
3=ZONE 97 98 99

Zone Setup Screen #1

ZONE SETUP ⇕
1=ZONES INSTALLED
2=ZONES ENABLED
3=ZONES DISABLED

Zone Setup Screen #2

ZONE SETUP ↑
1=ZONE TYPES

Zone Setup Screen #3

ZONE SETUP
1=ENABLE
2=DISABLE
3=ZONE 97 98 99

Zone Setup Screen #1

3.6.2.1 Enable

Pressing 1 for Enable, while viewing Zone Setup Screen #1, will display the following screen:

ZONE TO ENABLE
Z █

Enable Screen

This screens allows the programmer to enable zones, one at a time. A flashing cursor appears next to the Z, prompting the programmer to enter a two digit zone number (01 - 99). When the second digit is entered, the zone will be enabled and the cursor returns to the original position next to the Z. Another zone can then be enabled.

ZONE SETUP
1=ZONES INSTALLED
2=ZONES ENABLED
3=ZONES DISABLED
 Zone Setup Screen #2

3.6.2.4 Zones Installed

Pressing 1 for Zones Installed, while viewing Zone Setup Screen #2, will display a screen similar to the following:



Zones Installed Screen

This display will show all of the zones that have been programmed into the control panel. Note that an up and/or down arrow may appear in the upper right corner of the display, indicating that additional screens of zone information exists. Press the up or down arrow keys to view the additional zones.

3.6.2.5 Zones Enabled

Pressing 2 for Zones Enabled, while viewing Zone Setup Screen #2, will display a screen similar to the following:

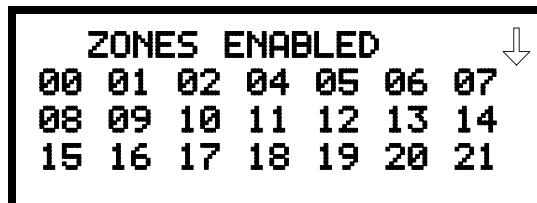

Zones Enabled Screen

This display will show all of the zones that are enabled in the control panel. Note that an up and/or down arrow may appear in the upper right corner of the display, indicating that additional screens of zone information exists. Press the up or down arrow keys to view the additional zones.

3.6.2.6 Zones Disabled

Pressing 3 for Zones Disabled, while viewing Zone Setup Screen #2, will display a screen similar to the following:



Zones Disabled Screen

This display will show all of the zones that are disabled in the control panel. Note that an up and/or down arrow may appear in the upper right corner of the display, indicating that additional screens of zone information exists. Press the up or down arrow keys to view the additional zones.

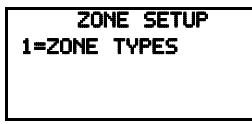

Zone Setup Screen #3

3.6.2.7 Zone Type

Zone Types must be programmed only if a DACT, programmed for zone reporting, is installed on the control panel. Pressing 1 for Zone Types, while viewing Zone Setup Screen #3, will display a screen similar to the following:

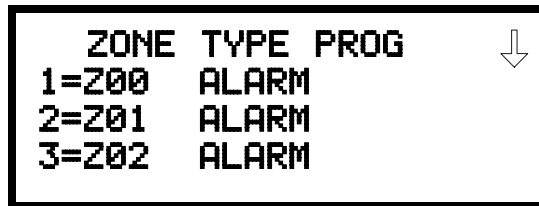

Zones Installed Screen

This display will show the system zones (default and user programmed) and their associated types. Note that an up and/or down arrow will appear in the upper right corner of the display, indicating that additional screens of zone information exists. Press the up or down arrow keys to view zones Z00 through Z99.

Zone types can be changed by pressing the keypad number key corresponding to the zone in each Zones Installed Screen. Available zone types will be displayed in the resultant screens. For example, to change the zone type for zone Z02 in the screen illustrated above, press 3. The following screens will be displayed:

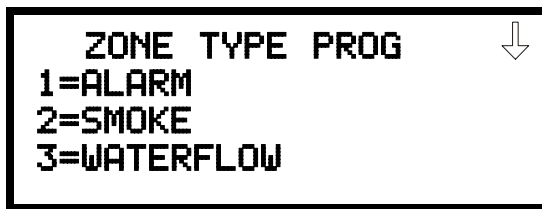

Zone Type Program Screen #1

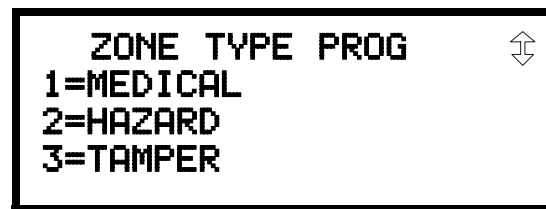

Zone Type Program Screen #3



Zone Type Program Screen #2

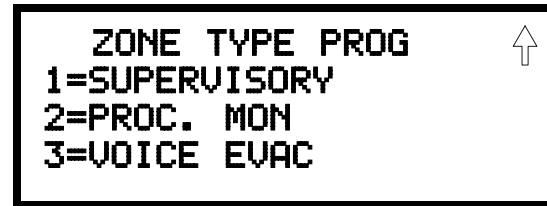

Zone Type Program Screen #4

To change the zone type for Z02 to Pull Station, scroll the display until Zone Type Program Screen #2 is displayed. Press 2 to program zone Z02 as a Pull Station zone. The display will return to the Zones Installed Screen showing zone Z02 and the Pull Station program type. Repeat the procedure for each zone to be changed.

IMPORTANT! In Zone Type Program Screen #1, selecting WATERFLOW will assign a Waterflow silenceable zone type to the selected zone. Any signaling devices programmed to the same zone can be silenced by pressing the Alarm Silence key or by using the auto-silence feature.

To program a waterflow circuit as nonsilenceable, connect the waterflow device(s) to a monitor module programmed as a Waterflow device (see "Edit Module Screen for Monitor Module" on page 55) and assign the module to a particular zone. Program a control module as nonsilenceable (see "Edit Module Screen for Control Modules" on page 63) and assign it to the same zone as the waterflow type monitor module. All notification appliances connected to the control module will be nonsilenceable as will any other devices assigned to the same zone.

PROGRAMMING 1=POINT PROGRAM 2=ZONE SETUP 3=LOOP SETUP
--

Programming Screen #1

3.6.3 Loop Setup

Loop Setup allows the programmer to configure the SLC Loop(s) for NFPA Style 4, 6 or 7 wiring and to select the protocol for each loop. Pressing 3 while viewing Programming Screen #1 will cause the following screen to be displayed:

<p style="text-align: center;">LOOP SETUP</p> 1=LOOP 1 2=LOOP 2

Loop Selection Screen

Press 1 while viewing the Loop Selection Screen to configure Loop1 or 2 to configure Loop 2. The following screens will appear for each loop.

<p style="text-align: center;">LOOP # SETUP</p> 1=STYLE 4 2=PROTOCOL CLIP

Loop Setup Screen

3.6.3.1 Style

To program the SLC Style for the selected loop, press 1 for Style, while viewing Loop Setup Screen. In the preceding example, the control panel is programmed for Style 4 SLC wiring as indicated by the 4 to the right of *Style* in the display. To change the wiring style, press 1 to toggle the display to read *Style 6*. Each press of the 1 key will cause the display to toggle between *Style 4* and *Style 6*. *Note that, when programming the Loop Style, the programmer can only select between Style 4 and Style 6. To program a system for Style 7 wiring, the programmer must select the Loop Setup for Style 6. Style 7 wiring is the same as Style 6 with the added requirement that each addressable device on the loop must have a pair of isolator modules, one on each side.*

3.6.3.2 Loop Protocol

Loop Protocol refers to the SLC loop mode of operation. At the present time, the only mode available is CLIP (Classic Loop Interface Protocol) which is used for the older legacy addressable devices such as the M300 Series modules and detectors. Note that the legacy devices can operate only in CLIP mode while the newer devices are compatible with all modes. Pressing 2 while viewing the Loop Setup Screen will have no effect on programming at this time.

Device Addressing

It is important to note that the MS-9600 addressable device capacity is 159 detectors and 159 control/monitor modules per SLC loop. Since older legacy addressable devices cannot be set to addresses above 099, the newer series devices must be used when addresses 100 to 159 are to be installed. It is permissible to mix old and new devices on the same loop only when operating in CLIP mode.

3.6.4 System Setup

System Setup allows the programmer to configure the following control panel features:

- *Trouble Reminder*: This feature, when enabled, provides an audible reminder that an alarm or trouble still exists on the FACP after the control panel has been silenced. The control panel piezo sounder will pulse once every 15 seconds during an alarm and every two minutes during a trouble condition, after the Alarm Silence or Acknowledge key is pressed. The piezo will continue to sound at these rates until the alarm or trouble condition is cleared. If the trouble condition is not cleared within 24 hours, the panel will reactivate the trouble sounder and retransmit the trouble condition to the central station if connected.
- *Banner*: This option allows the user to change the top line of the LCD display from the factory default readout of *FIRE LITE ALARMS INC* to a user defined readout when the control panel is in Normal condition.
- *Time-Date*: This feature allows the programmer to set the time, display format (24 hr or 12 hr), date and daylight savings time feature into the FACP memory
- *Timers*: This option allows the programmer to set the PAS (Positive Alarm Sequence) time delay, Pre-Signal time delay and Waterflow time delay.
- *NACs*: This feature allows the programmer to configure the two control panel Notification Appliance Circuits for a variety of options, such as circuit type, silenceable/nonsilenceable, autosilence, coding, silence inhibit, zone assignment and enable/disable.
- *Relays*: This option allows programming of two onboard relays for activation by various control panel events, such as alarm, trouble, supervisory, etc.

PROGRAMMING
1=SYSTEM SETUP
2=AUTOPROGRAM
3=VERIFY LOOPS

Programming Screen #2

Pressing *I* for System Setup, while viewing Programming Screen #2, will cause the following screens to be displayed:

SYSTEM SETUP ↓
1=TROUBLE REM OFF
2=BANNER
3=TIME-DATE

System Setup Screen #1

SYSTEM SETUP ↑
1=TIMERS
2=NAC
3=RELAYS

System Setup Screen #2

3.6.4.1 Trouble Reminder

The Trouble Reminder features causes the control panel piezo to sound a reminder 'beep' for alarms and troubles, after the panel has been silenced. Refer to "System Setup" on page 75, for a detailed description of this feature. Pressing *I* while viewing System Setup Screen #1 will cause the display to toggle to *Trouble Rem On*, which enables this feature. Each press of the *I* key will cause the display to toggle between *Trouble Rem On* and *Trouble Rem Off*.



See Page

3.6.4.2 Banner

The top line of the display, which appears when the control panel is in normal mode, can be changed by using the Banner option. Pressing 2 while viewing System Setup Screen #1 will cause the following to be displayed:



Banner Screen



Banner Screen

Pressing 1 while viewing the Banner Screen will select the factory default banner setting and display the following screen:



Factory Banner Screen

Pressing the Enter key will store this selection in nonvolatile memory and return the display to the Banner Screen.

Pressing 2 while viewing the Banner Screen will cause the following screen to be displayed:

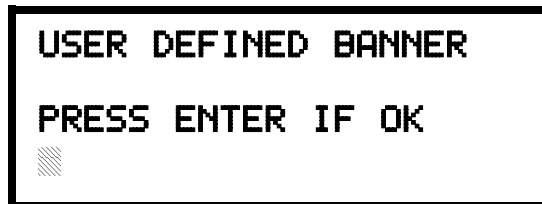

User Defined Banner Screen

This screen allows the programmer to enter a custom banner as the first line of the display. A flashing cursor will appear in the bottom left corner of the display. A maximum of 20 characters (including spaces) can be entered. To quickly clear the current banner, press the *CLR* key.

To enter alphanumeric characters from the keypad, repeatedly press the appropriate key until the desired character is displayed in the first position. For example, to enter the letter *B*, press the 2 (*ABC*) key three times to toggle through the characters *I*, *A* and *B*. Press the right arrow key to move the cursor one position to the right and repeat the process to enter the next character. To enter a space, press the * (*QZ*) key four times to place a blank in the desired position. When all characters have been entered, press the Enter key to store the information. The display will return to the Banner Screen.

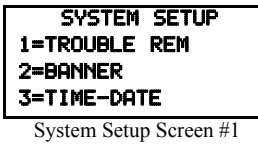

3.6.4.3 Time-Date

The control panel time and date can be changed by pressing 3 while viewing the System Setup Screen #1. The following screen will be displayed:

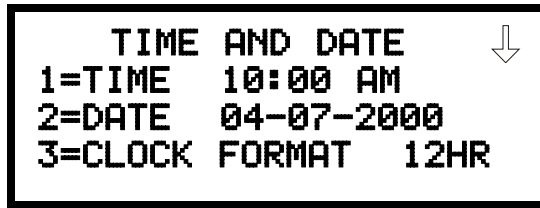

Time-Date Screen #1



Time-Date Screen #2

3.6.4.3.1 Time

To change the time, press 1 while viewing the Time-Date Screen. The following screen will be displayed:



Time Screen

A flashing cursor is located toward the top left of the display. Below the cursor is the current time. To change the time, enter the two-digit hours followed by the two-digit minutes. The cursor will move one position to the right each time a digit is entered. After the last minutes digit is entered, the cursor will again move one position to the right. At this point enter 1 for AM or 2 for PM. The display will then return to the Time-Date Screen which will show the new time entry. If an error is made while entering a digit, press the CLR key to delete the entire entry and beginning again.

3.6.4.3.2 Date

To change the date, press 2 while viewing the Time-Date Screen. The following screen will be displayed:



Date Screen

A flashing cursor is located toward the top left of the display. Below the cursor is the current date. To change the date, enter the two-digit month followed by the two-digit day and then the two-digit year (01 for 2001, 02 for 2002, etc.). The cursor will move one position to the right each time a digit is entered. After the last year digit is entered, the display will return to the Time-Date Screen which will show the new date entry. If an error is made while entering a digit, press the CLR key to delete the entire entry and beginning again.

3.6.4.3.3 Clock Format

The clock can be configured to display 12 hour (AM & PM) or 24 hour (military) time. Pressing 3 while viewing the Time-Date screen will cause the display to toggle between 12HR and 24HR. Select 12HR for 12 hour display or 24HR for 24 hour display.



Time & Date Screen #2

3.6.4.3.4 Daylight Savings Time

Pressing 1 while viewing Time-Date Screen #2 will cause the following screens to be displayed:



Daylight Savings Screen #1



Daylight Savings Screen #2

Pressing 1 while viewing Daylight Savings Screen #1 will cause the display to toggle between *Enabled Yes* and *Enabled No*. The control panel will automatically update the time for daylight savings time when *Enabled Yes* is selected.

Pressing 2 while viewing Daylight Savings Screen #1 will display another screen which allows the programmer to select the month that daylight savings time will begin. In this sub-screen, pressing 1 will select March, 2 will select April and 3 will select May.

Pressing 3 while viewing Daylight Savings Screen #1 will display two sub-screens which allow the programmer to select the week of the month that daylight savings time will begin. In the first sub-screen, pressing 1 will select the first week, 2 will select the second week and 3 will select the third week, while in the second sub-screen, pressing 1 will select the fourth week and 2 will select the last week of the selected month.

Pressing 1 while viewing Daylight Savings Screen #2 will display another screen which allows the programmer to select the month that daylight savings time will end. In this sub-screen, pressing 1 will select September, 2 will select October and 3 will select November.

Pressing 2 while viewing Daylight Savings Screen #2 will display two sub-screens which allow the programmer to select the week of the month that daylight savings time will end. In the first sub-screen, pressing 1 will select the first week, 2 will select the second week and 3 will select the third week, while in the second sub-screen, pressing 4 will select the fourth week and 5 will select the last week of the selected month.

```

SYSTEM SETUP
1=TIMERS
2=NAC
3=RELAYS
    
```

System Setup Screen #2

3.6.4.4 Timers

Timer delays for PAS, Pre-signal and waterflow activation can be programmed by pressing 1 while viewing System Setup Screen #2. The following screen will be displayed:

```

          TIMERS
1=PAS DELAY      000
2=PRE SIGNAL     000
3=WATERFLOW     000
    
```

Timer Screen #1

```

          TIMERS
1=AC LOSS DELAY  000
    
```

Timer Screen #2

```

TIMERS
1=PAS DELAY      000
2=PRE SIGNAL     000
3=WATERFLOW     000
    
```

Timer Screen #1

3.6.4.4.1 PAS (Positive Alarm Sequence) Delay

The factory default setting for PAS is 000 for no delay. To select a PAS delay of 001 to 180 seconds for all devices programmed for PAS, press 1 while viewing Timer Screen #1. The following display will appear:

```

          PAS DELAY
RANGE 0-180 SECONDS
    
```

PAS Delay Screen

A flashing cursor is positioned in the lower left corner of the display. Enter a delay time consisting of three digits, such as 005 for five seconds. Upon entering the third digit, the time delay will be stored in the control panel memory and the display will return to the Delay Screen which will indicate the new delay time.

3.6.4.4.2 Pre-signal Delay

The factory default setting for Pre-signal delay is 000 for no delay. To select a Pre-signal delay of 001 to 180 seconds for all devices programmed for Pre-signal, press 2 while viewing Timer Screen #1. The following screen will be displayed:



Pre-signal Delay Screen

A flashing cursor is positioned in the lower left corner of the display. Enter a delay time consisting of three digits, such as 009 for nine seconds. Upon entering the third digit, the time delay will be stored in the control panel memory and the display will return to the Delay Screen which will indicate the new delay time.

Note that the FACP can be programmed for either PAS or Pre-signal operation, not both. For this reason, if the PAS Delay timer is set with a value greater than 000 and then the Pre-Signal Delay timer is set with a value greater than 000, the PAS Delay timer will be automatically reset to 000. Only one of the two timers can have a delay time set for it.

TIMER	
1=	PAS DELAY 000
2=	PRE SIGNAL 000
3=	WATERFLOW 000

Timer Screen #1

3.6.4.4.3 Waterflow Delay

A delay can be added prior to declaring a waterflow type of alarm. Be careful to include any built-in delays of the waterflow device. The factory default setting for Waterflow delay is 000 for no delay. To select a Waterflow delay of 01 to 90 seconds for all devices programmed for Waterflow delay, press 3 while viewing Timer Screen #1. The following screen will be displayed:



Waterflow Delay Screen

A flashing cursor is positioned in the lower left corner of the display. Enter a delay time consisting of two digits, such as 25 for twenty-five seconds. Upon entering the second digit, the time delay will be stored in the control panel memory and the display will return to the Delay Screen which will indicate the new delay time.



Timer Screen #2

3.6.4.4 AC Loss Delay

The reporting of a loss of AC power to a central station can be delayed by programming the length of the desired delay. Press 1 while viewing Timer Screen #2 to display the following:

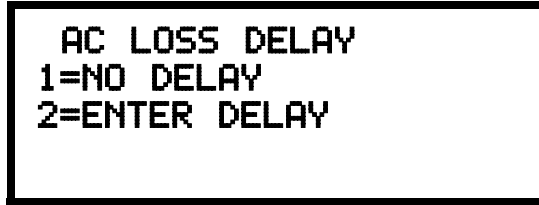

AC Loss Delay Screen #1

Pressing 1 while viewing AC Loss Delay Screen #1 will program the FACP to transmit an AC Loss report immediately to the central station.

Pressing 2 while viewing AC Loss Delay Screen #1 will display the following screen:



AC Loss Delay Screen #2

A flashing cursor will appear in the lower left corner of the display. Type the two digit AC loss reporting delay in hours (00 to 23 hour delay). When the second digit is entered, the display will return to AC Loss Delay Screen #1.

Note: For Central Station applications, AC Loss Reporting Delay must be set to a delay value ranging from 06 to 12 hours. For Remote Station applications, AC Loss Reporting Delay must be set to a delay value ranging from 15 to 23 hours.

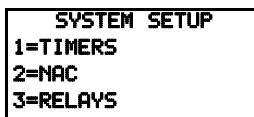

System Setup Screen #2

3.6.4.5 NAC (Notification Appliance Circuit)

The options for the two NACs on the control panel main circuit board can be configure by pressing 2 while viewing System Setup Screen #2. The following screens will be displayed:

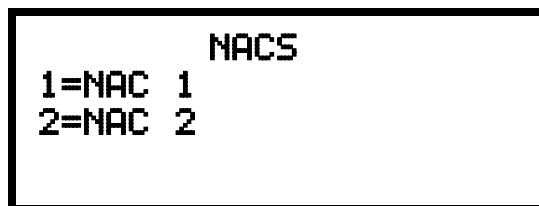

NAC Selection Screen

The Notification Appliance Circuits can be configured independently by pressing 1 for NAC 1 or 2 for NAC 2.

The following screens will be displayed for either selection:

```

                NAC #
1=ENABLED      YES
2=TYPE         BELL
3=SILENCEABLE YES
    
```

NAC Screen #1

```

                NAC #
1=AUTO SILENCE 00
2=CODING
                TEMPORAL
    
```

NAC Screen #2

```

                NAC #
1=ZONE
   00 00 00 00 00
2=SIL INHIBITED NO
    
```

NAC Screen #3

```

                NAC #
1=SYNC TYPE    S
    
```

NAC Screen #4

3.6.4.5.1 Enabled

Pressing *I* while viewing NAC Screen #1 will cause the display to change to *Enabled No*. This will prevent the selected main circuit board NAC from activating its devices. Each press of the *I* key will cause the display to toggle between *Enabled Yes* and *Enabled No*.

NAC #
 1=ENABLED
 2=TYPE
 3=SILENCEABLE
 NAC Screen #1

3.6.4.5.2 Type

The main circuit board NAC type can be programmed by pressing 2 while viewing NAC Screen #1. The following screens will be displayed:

NAC TYPE ↓
 1=BELL
 2=HORN
 3=STROBE

Type Screen #1

NAC TYPE ⇕
 1=SYNCED STROBE
 2=FUTURE
 3=AUDIBLE

Type Screen #2

NAC TYPE ↑
 1=FUTURE
 2=SIREN CIRCUIT
 3=BLANK

Type Screen #3

Select the NAC device type by pressing the number corresponding to the type in the appropriate screen as shown above. When the selection is made, the display will return to NAC Screen #1.

The following table contains NAC type codes and their functions:

NAC Type Code	Special Function
Bell	None
Horn	None
Strobe	None
Synced Strobe	Synchronized to manufacturer
Audible	None
Siren Circuit	None
Blank	None

3.6.4.5.3 Silenceable

Pressing 3 while viewing NAC Screen #1 will cause the display to change to *Silenceable No*. This will prevent the selected main circuit board NAC from being silenced by pressing the Alarm Silence key or by the Auto Silence feature. Each press of the 3 key will cause the display to toggle between *Silenceable Yes* and *Silenceable No*.

Important: When a Notification Appliance Circuit with a mix of audible and visual devices is programmed for silenceable and the synchronization feature is selected, only the audible devices will be turned off if the Silence key is pressed. The visual devices (strobes, etc.) will continue to operate.

```

NAC #
1=AUTO SILENCE
2=CODING
TEMPORAL
    
```

NAC Screen #2

3.6.4.5.4 Auto Silence

The Auto Silence feature, when enabled, automatically silences all main circuit board silenceable notification appliances after a programmed length of time. To enable this feature and program the time delay before Auto Silence activation, press *1* while viewing NAC Screen #2. The following screens will be displayed:

```

AUTO SILENCE
1=NO
2=5 MINUTES
3=10 MINUTES
    
```

Auto Silence Screen #1

```

AUTO SILENCE
1=15 MINUTES
2=20 MINUTES
3=25 MINUTES
    
```

Auto Silence Screen #2

```

AUTO SILENCE
1=30 MINUTES
    
```

Auto Silence Screen #3

To disable the Auto Silence feature, press *1* for *No* while viewing Auto Silence Screen #1. To enable the Auto Silence feature, press the number corresponding to the time delay which will elapse before Auto Silence activates. When a time delay is selected, the information will be stored in memory and the display will return to NAC Screen #2.

3.6.4.5.5 Coding

The Coding feature allows the programmer to select the type of output that the main circuit board notification appliances will generate when activated. Pressing *2* while viewing NAC Screen #2 will cause the following displays to appear:

```

CODING
1=STEADY
2=MARCH TIME
3=CALIFORNIA
    
```

Coding Screen #1

```

CODING
1=TEMPORAL
2=TWO STAGE
    
```

Coding Screen #2

The programmer can select the notification appliance output by pressing the number corresponding to the desired output. The coding selections are:

- Steady - a continuous output with no coding
- March Time - 120 ppm (pulse-per-minute) output
- California - 10 seconds on and 5 seconds off
- Temporal - 1/2 second on, 1/2 second off, 1/2 second on, 1/2 second off, 1/2 second on, 1 1/2 second off
- Two Stage - 20 ppm (pulse-per-minute) for five minutes followed by on steady

Selection of one of the above options will cause the control panel to store the information in memory and return the display to NAC Screen #2, which will display the new coding choice.

```

NAC #
1=ZONE
   00 00 00 00 00
2=SIL INHIBITED NO
    
```

NAC Screen #3

3.6.4.5.6 Zone

A maximum of five zones can be programmed to each main circuit board NAC. Pressing 1 while viewing NAC Screen #3 displays the following screen:

```

      ZONE ASSIGNMENT
Z00 Z** Z** Z** Z**
    
```

Zone Screen

Note that Z** represents the Zone Number(s) corresponding to the selected NAC. The factory default for an unprogrammed device is Z00 for general alarm zone. A flashing cursor will appear on the first 0 to the left. Enter the two digit number corresponding to the zone that is to be assigned to this NAC. The cursor moves to the next Z** designation. Continue entering zone assignments or the remaining zones can be left blank or programmed as general alarm zone Z00. When all desired changes have been made, press the Enter key to store the zone assignments. The display will return to the NAC Screen #3 which will show the zone assignments just entered.

3.6.4.5.7 Silence Inhibited

The Silence Inhibit feature, when enabled, prevents the silencing of the selected main circuit board NAC for a period of one minute. Pressing 2 while viewing NAC Screen #3 will cause the display to change from the factory default of *Silence Inhibit No* to *Silence Inhibit Yes*. Each press of the 2 key will cause the display to toggle between the two options.

```

NAC #
1=SYNC TYPE
    
```

NAC Screen #4

3.6.4.5.8 Synced Type

If synchronized strobes were selected as the Type of device installed, the type of synchronization must be selected in this option. Pressing 1 while viewing NAC Screen #4 will cause the following screen to be displayed:

```

      NAC SYNC TYPE
1=SYSTEM SENSOR
2=WHEELOCK
3=GENTEX
    
```

Pressing 1 while viewing this screen will select System Sensor synchronization, 2 will select Wheelock and 3 will select Gentex.

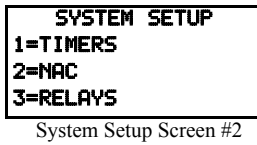

3.6.4.6 Relays

Pressing 3 while viewing System Setup Screen #2 will allow the programmer to configure two of the three main circuit board Form-C relays. The following screen will be displayed:

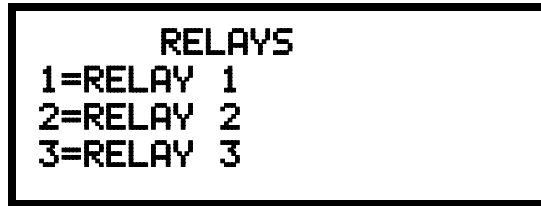

Relays Selection Screen

To program Relay 1 or Relay 3, press the number corresponding to the selected relay. Note that Relay 2 is fixed as a Trouble relay. Selecting Relay 2 will have no effect on its programming. The following screen will appear for each relay to be programmed:



Relay Type Screen

Pressing 1 for Type while viewing the Relay Screen will cause the following screens to be displayed:

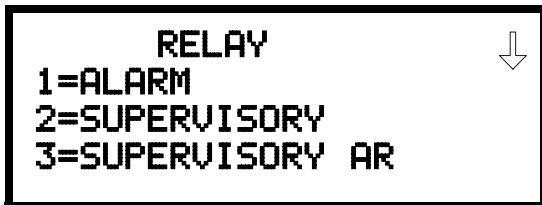

Relay Screen #1



Relay Screen #3



Relay Screen #2



Relay Screen #4

While viewing the selected screen, press the number corresponding to the desired relay type to program the main circuit board relay. The choice will be stored in memory and the display will return to the Relay Type Screen which will show the programmed type choice. Press the Escape key to return to the Relays Selection Screen and repeat the preceding procedure for the remaining relays.

Note: *AR* in *SUPERVISORY AR* and *PROCMON AR* indicates AutoResettable which means that the relay will not latch when either of these conditions occur. If the corresponding condition is cleared, the relay will return to its normal state without the necessity of resetting the control panel.

```

PROGRAMMING
1=SYSTEM SETUP
2=AUTOPROGRAM
3=VERIFY LOOPS
    
```

Programming Screen #2

3.6.5 Autoprogram

Pressing 2 while viewing Programming Screen #2, will select the Autoprogram option, which prompts the control panel to poll all devices installed on one or both SLC loops. The primary purpose of autoprogramming is to allow the installer a fast and easy way to bring the system on-line as quickly as possible. The first time the system is powered-up, it should be autoprogrammed.

If the system is already programmed and Autoprogram is initiated, the system will only add default values for newly installed devices.

When Autoprogram is selected, the programmer is given the option of autoprogramming all loops, only loop 1 or only loop 2. The following will be displayed on the LCD:

```

AUTOPROGRAM
1=LOOP 1
2=LOOP 2
3=ALL LOOPS
    
```

Autoprogram Loop Select Screen

After selecting one of the Autoprogram options, the control panel will begin autoprogramming the system by communicating with each addressable device installed on one or both loops. While autoprogramming, the panel will display the following:

```

AUTOPROGRAM
AUTOPROGRAMMING!
PLEASE WAIT
    
```

Autoprogram Progress Screen

When Autoprogramming is completed, the control panel will display the type and quantity of each device installed on the SLC loop(s) similar to the following display:

```

# OF DET LOOP1 055
# OF MON LOOP1 035
# OF CON LOOP1 030
    
```

Autoprogram Result Screen #1

```

# OF DET LOOP2 000
# OF MON LOOP2 000
# OF CON LOOP2 000
    
```

Autoprogram Result Screen #2

In the preceding example, the first display indicates that Loop 1 has 55 addressable detectors, 35 monitor modules and 30 control modules installed. The second display indicates that Loop 2 has no devices installed.

3.6.6 Verify Loops

```

PROGRAMMING
1=SYSTEM SETUP
2=AUTOPROGRAM
3=VERIFY LOOPS

```

Programming Screen #2

Pressing 3 while viewing Programming Screen #2, will select the Verify Loops option and display the following screen:

```

          VERIFY LOOPS
1=LOOP 1
2=LOOP 2
3=BOTH LOOPS

```

Verify Loop Select Screen

During loop verification, the FACP polls each device on the selected SLC to determine if the device is communicating and whether or not it responds with the proper type identification. The programmer can choose to verify one or both loops by pressing the number corresponding to the choices shown above. When the selection is made, the following screen will be displayed while verification is in progress:

```

          VERIFYING LOOPS
          PLEASE WAIT

```

Verification Progress Screen

When Loop verification has been completed, the display will indicate that the system is OK or, if problems have been detected, any device type programming errors. Use the up and down arrow keys to view all detected errors.

3.6.7 History

```

PROGRAMMING
1=HISTORY
2=WALKTEST
3=OPTION MODULES

```

Programming Screen #3

The History option allows an authorized user to view or erase events which have occurred in the control panel. Pressing 1 while viewing Programming Screen #3 will display the History options as shown in the following display:

```

          HISTORY
1=VIEW EVENTS
2=ERASE HISTORY

```

History Screen

```

HISTORY
1=VIEW EVENTS
2=ERASE HISTORY

```

History Screen

3.6.7.1 View Events

Pressing *1* while viewing the History Screen will allow the user to select the events to be viewed as illustrated in the following:

```

HISTORY
1=VIEW ALL
2=VIEW ALARMS
3=VIEW OTHER EVENTS

```

View Events Screen

While displaying the View Events screen, press *1* to view all events, *2* to view only alarms or *3* to view other events. Use the up and down arrow keys to scroll through all of the displayed events.

3.6.7.2 Erase History

The Erase History option allows a user to erase all events from the history file. This will provide a clean slate in order to use the history file to track future events.

Pressing *2* while viewing the History Screen will cause the following screen to be displayed:

```

ERASE HISTORY
PROCEED ?
1=YES 2=NO

```

Erase History Screen

Pressing *1* while viewing the Erase History Screen will erase all events from the History file. During this process, the display will read as follows:

```

ERASING HISTORY
PLEASE WAIT

```

Erase History Wait Screen

After the History file has been erased, the display will return to the History Screen.

3.6.8 Walktest

PROGRAMMING
1=HISTORY
2=WALKTEST
3=OPTION MODULES

Programming Screen #3

Walktest allows an individual to test the fire alarm system without the necessity to reset the control panel after each device activation. Pressing 2 while viewing the Programming Screen #3 will cause the following Walktest options to be displayed:

```

WALKTEST
1=SILENT
2=AUDIBLE
3=VIEW RESULT

```

Walktest Screen

To perform a silent walktest which will not sound the NACs, press 1 while viewing the Walktest Screen. To perform an audible walktest, which will sound the NACs, press 2 while viewing the Walktest Screen. When either option is chosen, the panel will enter Walktest Mode and the following screen will be displayed:

```

UNIT IN WALKTEST

```

Walktest Active Screen

The user can now perform a one-person walktest by activating devices throughout the system. As each device is activated, the screen will display the information about the activated device as shown below. Note that the colon in the time is replaced with an asterisk to distinguish the walktest screen from an actual alarm screen.

```

ALARM  PULL STATION
      <ADJ> <NOUN>
                Z000
10*00A 010801 1M001

```

After completion of the Walktest, press the *Esc* (Escape) key to exit Walktest Mode and return to the Walktest Screen. The results of the Walktest can now be viewed by pressing 3 while viewing the Walktest Screen. The following screen will be displayed:

```

WALKTEST RESULTS

```

View Result Screen

Use the up and down arrow keys to view all of the walktest results which will be displayed as illustrated in the preceding screen. Note that the Walktest log is stored in RAM. If all power (AC and DC) is removed from the FACP, the Walktest log information will be lost. This information is also overwritten when subsequent walktests are performed.

3.6.9 Option Modules

```

PROGRAMMING
1=HISTORY
2=WALKTEST
3=OPTION MODULES
    
```

Programming Screen #3

Options available for the MS-9600 include ACM Series, Graphic and LCD annunciators, UDACT-F Digital Alarm Communicator/Transmitter, printer connection for acquiring hardcopy printouts of panel data and PC (Personal Computer) connection for uploading and downloading panel data.

Pressing 3 while viewing Programming Screen #3 will display the following screen:

```

OPTION MODULES
1=ANNUNCIATORS/UDACT
2=(NOT USED)
3=PRINTER/PC   PR4800
    
```

Options Screen

Note that *PR4800* in the display indicates that a supervised printer, configured for 4800 baud, has been previously programmed into the system.

3.6.9.1 Annunciators/UDACT

Pressing 1 while viewing the Options Screen will cause the control panel to display the following screens:

```

ANNUNCIATOR
1=TERM ENABLED   YES
2=ACS ENABLED   YES
3=UDACT         YES
    
```

Annunciator Screen #1

```

ANNUNCIATOR
1=ACS INSTALLED
    
```

Annunciator Screen #2

A Terminal Mode annunciator*, ACS Mode annunciator and remote UDACT can be installed in the MS-9600 system. To enable any of these devices, press the number corresponding to the selected device shown in Annunciator Screen #1 so that *Yes* appears in the display to the right of the device. Each press of the corresponding number key will cause the display to toggle between *Enabled Yes* and *Enabled No*.

*Note: The LCD-80F is a Terminal Mode annunciator. To enable the MS-9600 for LCD-80F operation, program *Term Enabled* to *Yes*.

If an ACS annunciator is installed, press *1* while viewing Annunciator Screen #2 to select addresses for the ACS annunciators. The following screen will be displayed:

ANNUNCIATOR		
1=ADDRESS 1		YES
2=ADDRESS 2		NO
3=ADDRESS 3		NO

ACS Installed Screen

Pressing the down arrow key will allow the programmer to view additional screens displaying Addresses 1 -31. To select one or more addresses for the installed ACS annunciator(s), press the number key corresponding to the address in each screen. The display for the selected address will change from *No* to *Yes*. Each press of the number key will cause the display to toggle between *No* and *Yes*.

3.6.9.2 Printer/PC

A Printer or a PC can be connected to the control panel. Pressing *3* while viewing the Option Module Screen will cause the following screen to appear:

OPTION MODULES	
1=ANNUNCIATORS/UDACT	
2=ON BOARD DACT	
3=PRINTER/PC	NO

Option Module Screen

PRINTER-PC		
1=PRINTER NO SU		NO
2=PRINTER SU		YES
3=PC		NO

Printer-PC Screen

Pressing *1* while viewing the Printer-PC Screen will program the control panel for an unsupervised (*NO SU*) printer. The display will change to the Printer Baud Rate Screen as shown below.

Pressing *2* while viewing the Printer-PC Screen will program the control panel for a supervised (*SU*) printer. Printer supervision, when enabled, will typically detect the removal of the printer cable and will detect when the printer power has been turned off. Depending upon the brand of printer, other errors such as paper empty or printer off-line may be detected.

The following screen will appear, which allows the programmer to select the baud rate for the printer communication:

PRINTER BAUD RATE	
1=2400 BAUD	
2=4800 BAUD	
3=9600 BAUD	

Printer Baud Rate Screen

Pressing the number key corresponding to the desired baud rate (*2* for 4800 Baud for example) will program the control panel for the selected baud rate and return the display to the Option Module Screen which will indicate *Printer/PC PR4800* for a supervised printer installed at 4800 baud rate.

Pressing *3* while viewing the Printer-PC Screen will program the control panel for a PC connection. The display will return to the Option Module Screen which will indicate *Printer/PC PC* for personal computer installed.

3.6.10 Password Change

```

PROGRAMMING
1=PASSWORD CHANGE
2=CLEAR PROGRAM
3=PROGRAM CHECK

```

Programming Screen #4

The factory set passwords, which have been programmed into the control panel, can be changed by selecting the Password Change option. Pressing *1* while viewing Programming Screen #4 will cause the following screen to be displayed:

```

PASSWORD CHANGE
1=MASTER
2=MAINTENANCE

```

Password Change Screen

Press *1* to change the Master Programming Level password or *2* to change the Maintenance Level password. *Note that the passwords will not be displayed on LCD-80F annunciators.*

The following screen will appear when either change option is selected:

```

ENTER NEW FIVE DIGIT
PASSWORD

```

Enter Password Screen

A flashing cursor will appear in the center of the display. Enter a new five digit password (such as 10101 for the Master Level). After the fifth digit is entered, the following screen will be displayed:

```

NEW MASTER
PASSWORD IS 10101
PRESS ENTER IF OK

```

Password Change Screen

Pressing the *Enter* key will program the new password into the control panel and return the display to the Password Change Screen.

3.6.11 Clear Program

```

PROGRAMMING
1=PASSWORD CHANGE
2=CLEAR PROGRAM
3=PROGRAM CHECK

```

Programming Screen #4

Pressing 2 while viewing Programming Screen #4, will select the Clear Program option. This will cause the LCD to display the following screens:

```

CLEAR PROGRAM
1=WHOLE SYSTEM
2=ALL LOOPS
3=LOOP1

```

Clear Program Screen #1

```

CLEAR PROGRAM
1=LOOP2

```

Clear Program Screen #2

Pressing 1, for Whole System while viewing the Clear Program Screen #1, will clear all general system programming options and all programmed addressable devices from the nonvolatile memory of the FACP. *This function is useful when the control panel is first installed, prior to autoprogramming. Note that it is necessary to autoprogram after using the Clear Whole System function.*



See Page

Pressing 2, for All Loops while viewing the Clear Program Screen #1, will clear all programming related to all SLC loops and connected addressable devices.

Pressing 3, for Loop 1 while viewing the Clear Program Screen #1, will clear only the programming related to SLC Loop 1 and the connected addressable devices.

Pressing 1, for Loop 2 while viewing the Clear Program Screen #2, will clear only the programming related to SLC Loop 2 and the connected addressable devices.

Before executing any of the Clear commands listed above, the control panel will provide a warning to the user by prompting with the following display:

```

WARNING!
SYSTEM CHANGE
PROCEED?
1=YES                2=NO

```

Pressing 1 will cause the control panel to carry out the selected clear option. Pressing 2 will prevent programming from being cleared.

3.6.12 Program Check

```

PROGRAMMING
1=PASSWORD CHANGE
2=CLEAR PROGRAM
3=PROGRAM CHECK

```

Programming Screen #4

The Program Check feature allows the programmer to view the zones which have been programmed to the Notification Appliance Circuits on the control panel but have not been programmed to Initiating Devices as well as other circuits with no input or output correlations. Pressing 3 while viewing Programming Screen #4 will cause the following screen to be displayed:

```

PROGRAMCHECK
1=NACS NO INPUT
2=ZONES NO INPUT
3=ZONES NO OUTPUT

```

```

PROGRAMCHECK
1=NACS NO INPUT
2=ZONES NO INPUT
3=ZONES NO OUTPUT

```

Program Check Screen

Pressing 1 while viewing the Program Check screen will display an NAC screen similar to the following.

```

NACS NO INPUT
NAC 1
    25 31 44 55 67

```

The example above indicates that NAC 1 has been programmed to Zones 25, 31, 44, 55 and 67 but no input devices have been programmed to any of these zones. Use the up and down arrow keys to view all the NAC zones without input assignments for both NAC 1 and NAC2.

Pressing 2 while viewing the Program Check screen will display a screen similar to the following:

```
ZONES NO INPUT
05 07 09 10 11 1M001
```

The Zone No Input screen allows the programmer to view the zones which have not been programmed to at least one input device (not including general alarm Zone 00). The example in the preceding screen indicates that Zones 05, 07, 09, 10 and 11 have been programmed to an addressable module (control module in this example) with an address of 001 on loop 1 but have not been programmed to any input devices. Use the up and down arrow keys to view all the zones without input assignments.

Pressing 3 while viewing Program Check screen will cause a screen similar to the following to be displayed:

```
ZONES NO OUTPUT
05 07 09 10 11 1D001
```

The Zone No Output feature allows the programmer to view the zones which have not been programmed to at least one output device (not including general alarm Zone 00). The example in the preceding screen indicates that Zones 05, 07, 09, 10 and 11 have been programmed to an addressable detector with an address of 001 on loop 1 but have not been programmed to any output devices. Use the up and down arrow keys to view all the zones without output assignments.

3.7 Maintenance Programming Level

To access Maintenance Programming mode, press the *Enter* key. The LCD will display the following:

```
1=READ STATUS
2=PROGRAMMING
```

To enter the Maintenance Programming mode, press 2. The display will read as follows:

```
PROGRAMMING
ENTER PASSWORD
```

When the *Maintenance* level password (default *1111*) is entered, the following screen will appear:

```
PROGRAMMING
1=POINT PROGRAM
2=HISTORY
3=PROGRAM CHECK
```



Note that in the preceding screens, an arrow appears to inform the programmer that additional options can be viewed by pressing the keypad *down* arrow key, as shown in the following screen.

```
PROGRAMMING
1=WALKTEST
2=SYSTEM
3=ZONE SETUP
```



3.7.1 Disable Point

```

PROGRAMMING
1=POINT PROGRAM
2=HISTORY
3=PROGRAM CHECK

```

Maintenance Screen #1

Pressing *1* for Point Program, while viewing Maintenance Screen #1 will cause the following screens to be displayed:

```

POINT PROGRAM
1=LOOP 1
2=LOOP 2

```

Loop Select Screen

Select the Loop, containing the device to be disabled, by pressing *1* for Loop 1 or *2* for Loop 2. A screen will then be displayed, allowing the operator to select the type of addressable device to be disabled as shown in the following display:

```

POINT PROGRAM
1=DETECTOR
2=MODULE

```

Device Select Screen

Select the device type by pressing *1* for an addressable detector or *2* for an addressable module. The operator will be prompted to enter the three digit device address as shown in the following example for a detector:

```

EDIT DETECTOR
ENTER POINT ADDRESS
**

```

Address Select Screen

A flashing cursor will appear in the bottom left corner of the display, prompting for the three digit device address. When the third digit is enter, *001* for example, a screen will appear which will allow enabling or disabling of the selected point, as illustrated in the following example:

```

EDIT DETECTOR 10001
1=ENABLED YES

```

Enable/Disable Select Screen

Pressing *1* repeatedly will cause the display to toggle between *Enabled Yes* and *Enabled No*.

3.7.2 History

```

PROGRAMMING
1=POINT PROGRAM
2=HISTORY
3=PROGRAM CHECK

```

Maintenance Screen #1

Pressing 2 while viewing Maintenance Screen #1 will cause the following screen to be displayed:

```

HISTORY
1=VIEW EVENTS
2=ERASE HISTORY

```

History Screen

The History feature allows the operator to view control panel events which have been stored in a history file in memory and erase the contents of the history file

Pressing 1 while viewing the History screen will cause the following screen to be displayed:

```

HISTORY
1=VIEW ALL
2=VIEW ALARMS
3=VIEW OTHER EVENTS

```

Events Screen

To view all the events which have occurred in the control panel since the history file was last erased, press 1 while viewing the Events screen. To view only alarms which have occurred, press 2 while viewing the Events screen. To view events other than alarms, press 3. The most recent event will be displayed on the screen. To view all of the selected events, press the up or down arrow keys to scroll through the list of events. If no events have occurred, the display will read *NO EVENTS IN HISTORY*.

Pressing 2 while viewing the History Screen will cause the following screen to be displayed:

```

ERASE HISTORY
PROCEED ?
1=YES          2=NO

```

Erase History Screen

Pressing 1 while viewing the Erase History Screen will cause the message *ERASING HISTORY, PLEASE WAIT* to be displayed. The display will then return to the History Screen. Pressing 2 will cause the display to return to the History Screen without erasing the History file.

3.7.3 Program Check

```

PROGRAMMING
1=POINT PROGRAM
2=HISTORY
3=PROGRAM CHECK
    
```

Maintenance Screen #1

Pressing 3 while viewing Maintenance Screen #1 will cause the following screen to be displayed:

```

PROGRAMCHECK
1=NACS NO INPUT
2=ZONES NO INPUT
3=ZONE NO OUTPUT
    
```

Program Check Screen

The Program Check feature allows the programmer to view the zones which have been programmed to the Notification Appliance Circuits on the control panel but have not been programmed to Initiating Devices as well as other circuits with no input or output correlations. Pressing 1 while viewing Program Check screen will cause a screen similar to the following to be displayed.

```

NACS NO INPUT
NAC 1
  25 31 44 55 67
    
```

The example above indicates that NAC 1 has been programmed to Zones 25, 31, 44, 55 and 67 but no input devices have been programmed to any of these zones. Use the up and down arrow keys to view all the NAC zones without input assignments for both NAC 1 and NAC2.

Pressing 2 while viewing the Program Check screen will display a screen similar to the following:

```

ZONES NO INPUT
05 07 09 10 11 1M001
    
```

The Zone No Input screen allows the programmer to view the zones which have not been programmed to at least one input device (not including general alarm Zone 00). The example in the preceding screen indicates that Zones 05, 07, 09, 10 and 11 have been programmed to an addressable module (control module in this example) with an address of 001 on loop 1 but have not been programmed to any input devices. Use the up and down arrow keys to view all the zones without input assignments.

Pressing 3 while viewing Program Check screen will cause a screen similar to the following to be displayed:

```

      ZONES NO OUTPUT
05 07 09 10 11 1D001
  
```

The Zone No Output feature allows the programmer to view the zones which have not been programmed to at least one output device (not including general alarm Zone 00). The example in the preceding screen indicates that Zones 05, 07, 09, 10 and 11 have been programmed to an addressable detector with an address of 001 on loop 1 but have not been programmed to any output devices. Use the up and down arrow keys to view all the zones without output assignments.

3.7.4 Walktest

```

      PROGRAMMING
1=WALKTEST
2=SYSTEM
3=ZONE SETUP
  
```

Maintenance Screen #2

To perform a walktest, press 1 while viewing Maintenance Screen #2. The following screen will be displayed:

```

      WALKTEST
1=SILENT
2=AUDIBLE
3=VIEW RESULT
  
```

Walktest Screen

The operator can press 1 to perform a silent walktest or 2 to perform an audible walktest. The display will read *UNIT IN WALKTEST*. To end the Walktest, press the Esc (Escape) key.

Pressing 3 after the walktest has been completed, will allow the operator to view the results of the walktest.

3.7.5 System

To program the time and date into the control panel, press 2 while viewing Maintenance Screen #2. The following display will appear:

```

      SYSTEMS
1=TIME/DATE
  
```

System Screen

Pressing *1* while viewing the System Screen will cause the following screen to be displayed:



TIME AND DATE
1=TIME 01:00 AM
2=DATE 01-01-2001
12HR

Time and Date Screen

To change the time, press *1* to display the following screen:



ENTER TIME
01:00 AM
1=AM 2=PM

Time Screen

A flashing cursor will appear on the left side of the display. Enter the four digit number corresponding to the time (0000 - 1259). When the fourth digit is entered, the cursor will move one position to the right. Press *1* for AM or *2* for PM to complete entering the time. The display will return to the Time and Date Screen displaying the new time.

To change the date, press *2* while viewing the Time and Date Screen. The following screen will be displayed:



ENTER DATE
MONTH DAY YEAR
01-01-2001

Date Screen

A flashing cursor will appear on the left side of the display. Enter the two digit month, two digit day and four digit year. The cursor will move one position to the right after each entry. When the fourth digit of the year has been entered, the display will return to the Time and Date Screen which will show the new date.

3.7.6 Zone Setup

```
PROGRAMMING
1=WALKTEST
2=SYSTEM
3=ZONE SETUP
```

Maintenance Screen #2

Pressing 3 while viewing Maintenance Screen #2 will display the following screen:

```
ZONE SETUP
1=ENABLE
2=DISABLE
3=ZONE 97 98 99
```

Zone Setup Screen

Pressing 1 while viewing Zone Setup screen will display the following screen:

```
ZONE TO ENABLE
Z
```

Enable Screen

A flashing cursor appears to the right of the Z. To enable a zone, enter the two digit zone number (00 - 99). After the second digit is entered, the zone will be enabled and the cursor will return to the original position. The next zone to be enabled can then be entered. Press Esc (Escape) to return to the previous screen.

Pressing 2 while viewing Zone Setup screen will display the following screen:

```
ZONE TO DISABLE
Z
```

Disable Screen

A flashing cursor appears to the right of the Z. To disable a zone, enter the two digit zone number (00 - 99). After the second digit is entered, the zone will be disabled and the cursor will return to the original position. The next zone to be disabled can then be entered. Press Esc (Escape) to return to the previous screen.

Pressing 3 while viewing Zone Setup screen will display the following screen:

SPEC PURPOSE ZONE		
1=PAS	97	OFF
2=PRE-SIGNAL	98	OFF
3=FUTURE	99	OFF

Disable Screen

Zones 97, 98 and 99 can be programmed for normal zone operation or for special purpose applications. In the above illustration, the three zones are shown Off, which means they can be programmed to function in the same manner as all other zones, by assigning them to input and output devices in the Programming Zone Assignment Screen.

Pressing 1 will cause the display to change to *PAS 97 On*. Each press of the 1 key will cause the display to toggle between *PAS 97 On* and *PAS 97 Off*. When Zone 97 is programmed On, a PAS (Positive Alarm Sequence) activation of any device will cause Zone 97 to activate. By assigning Zone 97 to a control module in the Programming Zone Assignment Screen, an output device connected to the control module can be used to indicate a PAS condition in the control panel. *Do not assign Zone 97 to a Notification Appliance Circuit when using this zone to indicate a PAS condition.*

Pressing 2 will cause the display to change to *Pre-signal 98 On*. Each press of the 2 key will cause the display to toggle between *Pre-signal 98 On* and *Pre-signal 98 Off*. When Zone 98 is programmed On, a Pre-signal activation of any device will cause Zone 98 to activate. By assigning Zone 98 to a control module in the Programming Zone Assignment Screen, an output device connected to the control module can be used to indicate a Pre-signal condition in the control panel. *Do not assign Zone 98 to a Notification Appliance Circuit when using this zone to indicate a Pre-signal condition.*

Zone 99, in special purpose mode, is reserved for future use and has no effect.

SECTION 4 Operating Instructions

4.1 Panel Control Buttons

4.1.1 Acknowledge/Step

The first press of the *Acknowledge/Step* key silences the piezo sounder, changes flashing LEDs to steady and also changes the status field on the LCD display from capital letters to small letters. When the piezo is silenced, an *acknowledge* message is sent to the printer and the history file. Multiple active events are scrolled on the display at a three second rate. *Acknowledge* also sends a *silence piezo* command to the optional annunciators connected to the FACP.

When more than one event exists, the first press of the Acknowledge/Step key functions as described in the preceding paragraph. The second press of the key stops the scrolling and holds the event on the display for one minute. Subsequent pressing of the key *steps* through each active event.

4.1.2 Alarm Silence

The *Alarm Silence* key performs the same functions as Acknowledge/Step. In addition, if an alarm exists, it turns off all silenceable NACs (Notification Appliance Circuits) and causes the Alarm Silenced LED to turn on. It also sends an 'alarm silenced' message to the printer, history file and optional annunciators. A subsequent new alarm will resound the system NACs. *Note that the Alarm Silenced LED is turned off by pressing the Reset key, the Drill key or subsequent activation of the NACs.*

4.1.3 Drill/Hold 2 Sec

When the *Drill* key is held for a minimum of two seconds (time required to prevent accidental activations), the FACP turns on both main panel NAC outputs and all silenceable circuits such as control modules that are programmed as silenceable, and turns off the Alarm Silenced LED if it was previously on. The *EVAC IN SYSTEM* message is shown on the LCD display. The same message is sent to the printer and history file. The *Alarm Silence* key can be used to turn off all silenceable NAC outputs following activation by the *Drill* key.

4.1.4 Reset

Pressing and releasing the *Reset* key turns off all control modules and NACs, temporarily turns off resettable power to 4-wire detectors, causes a *RESET IN SYSTEM* message to be displayed on the LCD and sends the same message to the printer and history file. It also performs a lamp test by turning on all LEDs (except the Ground LED), piezo sounder and LCD display segments after the *Reset* key is released. Any alarm or trouble that exists after a reset will resound the system.

4.2 LED Indicators

The nine LED indicators, which are located on the front panel, operate as follows:

AC Power

This is a green LED which illuminates if AC power is applied to the FACP. A loss of AC power will turn off this LED

Fire Alarm

This red LED flashes when one or more alarms occur. It illuminates steady when the *Acknowledge/Step* or *Alarm Silence* key is pressed. The Fire Alarm LED turns off when the *Reset* key is pressed. The LED will remain off if all alarms have been cleared.

Supervisory

This is a yellow LED that flashes when one or more supervisory conditions occur, such as a sprinkler valve tamper condition. It illuminates steady when the *Acknowledge/Step* or *Alarm Silence* key is pressed. It turns off when the *Reset* key is pressed and remains off if all supervisory alarms have been cleared.

Trouble

This is a yellow LED that flashes when one or more trouble conditions occur. It stays on steady when the *Acknowledge/Step* or *Alarm Silence* key is pressed. The LED turns off when all trouble conditions are cleared. This LED will also illuminate if the microprocessor watchdog circuit is activated.

Maintenance

This is a yellow LED that flashes to indicate that a smoke detector requires cleaning or replacement due to an invalid chamber reading or excessive drift.

Alarm Silenced

This is a yellow LED that turns on after the *Alarm Silence* key is pressed while an alarm condition exists. It turns off when the *Drill* or *Reset* key is pressed.

Disabled

This is a yellow LED that flashes to indicate that a zone, NAC, detector or module has been temporarily disabled in programming by the user.

Battery

This is a yellow LED that flashes to indicate a low battery voltage condition.

Ground

This is a yellow LED that flashes to indicate a ground fault condition.

4.3 Normal Operation

With no alarms or troubles in the system, the display message is *System All Normal* along with the current time and date as shown below. To set the time and date, refer to the appropriate section in this manual.



```
FIRE-LITE ALARMS INC
SYSTEM ALL NORMAL
10:00A 010801
```

The MS-9600 performs the following functions at regular intervals while in Normal mode:

- ✓ Monitors AC input voltage and battery voltage
- ✓ Monitors and reports status of SLC loop(s), option cards and control panel
- ✓ Polls all devices on the SLC loop(s) and flashes each device LED while checking for valid replies, alarms, troubles, etc.
- ✓ Refreshes LCD display and updates time
- ✓ Scans control panel keypad for key presses
- ✓ Performs autotest for all SLC devices
- ✓ Tests memory
- ✓ Updates and reads all communications busses (EIA-485, EIA-232, etc.)

4.4 Trouble Operation

With no alarms in the system, the detection of a trouble will cause the following:

- The piezo to pulse 1 second On and 1 second Off
- The system Trouble LED to flash one second On and one second Off
- The trouble relay to activate
- *TROUBL* with device type, noun/adjective, address and trouble description will appear on the LCD display
- The same message, along with the time and date, is sent to the optional printer and the history buffer.

Note that specific troubles will initiate additional actions; for example, loss of AC power will turn off the AC Power LED, a ground fault will turn on the Ground LED, etc.

Addressable Smoke Detectors, Monitor Modules and Control Modules

For addressable devices connected to the SLC loop, the following is a typical message that could appear on the LCD display for a device trouble:

```

TROUBL SMOKE (PHOTO)
  <ADJ> <NOUN>
                INVREP
10:00A 010801 1D001
  
```

The information displayed in the above example provides the following information:

- First line in display:
 - ✓ The type of event; in this example *TROUBL* indicating a device trouble
 - ✓ Device type identifier; in this example, *SMOKE (PHOTO)* indicates a Photoelectric smoke detector. Other device type identifiers which can be displayed include *SMOKE (ION)* for Ionization Detector, *HEAT* for Heat Detector, *CONTROL* for Control Module and *MONITOR* for Monitor Module, *PULL STATION* for a manual pull box, etc. Refer to "Edit Detector" on page 44, "Edit Module Screen for Monitor Module" on page 55 and "Edit Module Screen for Control Modules" on page 63 for information on additional device types.
- Second line in display:
 - ✓ <ADJ>; refers to the user programmed adjective descriptor from library list resident in the control panel or custom entry via PC.
 - ✓ <NOUN>; refers to the user programmed noun descriptor from library list resident in the control panel or custom entry via PC.
- Third line in display: *INVREP* indicates an invalid reply from the addressable device. Other possible troubles include:
 - SHORT* - indicating a shorted circuit on an addressable device
 - OPEN* - indicating an open circuit on an addressable device
 - DIRTY1* - maintenance alert indicating that a detector is near but below the allowed alarm limit and is in need of maintenance before the performance is compromised
 - DIRTY2* - maintenance alert indicating that a detector needs immediate maintenance since it has been within 80% of its alarm threshold for 24 hours
 - INVREP* - maintenance alert indicating a hardware problem in the detector
 - TEST F* - indicating a detector has failed the automatic test operation which functionally checks its sensing chamber and electronics
 - INV ID* - indicating that an incorrect device code (Type ID) has been programmed for an installed device (for example, Photo has been programmed but an Ion detector has been installed)
 - SW TBL* - indicating a module has failed the testing of its Class A switching relay
- Fourth line in display:
 - ✓ Time; the current time in this example is *10:00A* which represents 10:00 AM
 - ✓ Date; the current month, day and year in this example is *01* for January, *08* for the 8th day of the month and *01* for the year 2001
 - ✓ Device Address; *1D001* in this example *1* represents SLC Loop1, *D* represents a detector and *001* represents device address 001

Pressing the *Acknowledge/Step* or *Alarm Silence* key will cause the pulsing piezo to silence and the system Trouble LED to change from flashing to on steady. This block acknowledgment occurs regardless of the number of troubles, alarms and supervisory events active in the system. When the *Acknowledge/Step* key is pressed and at least one new alarm or trouble exists in the system, the 'acknowledge' message is sent to the printer and history file. If the trouble clears, either before or after the *Acknowledge/Step* key is pressed, the 'clear trouble' message is sent to the printer and history file.

If all troubles clear and there are no supervisory or fire conditions active in the system, the system returns to normal mode operation and the *System All Normal* message is shown on the LCD display and sent to the history and printer files. The auto-restore feature will restore cleared troubles even if the troubles were never acknowledged. Note that pressing the *Alarm Silence* key when only troubles exist in the system will have the same effect as pressing the *Acknowledge/Step* key except the Alarm Silenced LED will light.

If multiple trouble conditions exist in the system, they will be automatically scrolled on the LCD display at a three second rate. *If a combination of alarms, troubles and/or supervisory conditions simultaneously occur in the system, only the alarms are scrolled on the display.*

4.5 Alarm Operation

Alarm operation is similar to trouble operation with the following differences:

- The piezo sounder produces a steady output as opposed to a pulsed output
- The Fire Alarm LED flashes 1 second On and 1 second Off
- The LCD displays *Alarm* along with the device name, type, address, adjective/noun, associated zones and time/date
- Alarms latch and *are not allowed to clear automatically*
- Alarms activate software zones if so programmed
- Timers for Silence Inhibit, Autosilence and Trouble Reminder are started
- Alarms activate the general alarm relay and general alarm zone Z00
- The trouble relay is not activated
- Store event in history buffer

A typical alarm display would be as illustrated below:

```

ALARM  PULL STATION
      <ADJ> <NOUN>
                Z000
10:00A 010801 1M001
  
```

Note that the device type, which in this example is *PULL STATION*, can be any other programmable alarm type.

The information displayed in the above example provides the following information:

- First line in display:
 - ✓ The type of event; in this example *ALARM* indicating an alarm condition
 - ✓ Device type identifier; in this example, *PULL STATION* indicates a manual pull box. Other device type identifiers which can be displayed include *SMOKE (ION)* for Ionization Detector, *HEAT* for Heat Detector, *CONTROL* for Control Module and *MONITOR* for Monitor Module, *PULL STATION* for a manual pull box, etc. Refer to "Edit Detector" on page 44, "Edit Module Screen for Monitor Module" on page 55 and "Edit Module Screen for Control Modules" on page 63 for information on additional device types.
- Second line in display:

- ✓ <ADJ>; refers to the user programmed adjective descriptor from library list resident in the control panel or custom entry via PC.
- ✓ <NOUN>; refers to the user programmed noun descriptor from library list resident in the control panel or custom entry via PC.
- Third line in display: *Z000* indicates the zone programmed to this device which, in this example, is general alarm Zone 000. Note that a single device can be programmed to five different zones but only the first zone will be displayed.
- Fourth line in display:
 - ✓ Time; the current time in this example is *10:00A* which represents 10:00 AM
 - ✓ Date; the current month, day and year in this example is *01* for January, *08* for the 8th day of the month and *01* for the year 2001
 - ✓ Device Address; *1M001* in this example *1* represents SLC Loop1, *M* represents a module and *001* represents device address 001

4.6 Supervisory Operation

Supervisory operation is similar to alarm operation but with the following differences:

- The piezo sounder pulses ½ second On and ½ second Off
- The Supervisory LED flashes ½ second On and ½ second Off
- The LCD displays the status label *Active Supervisory* along with the device name, type, address, adjective/noun, associated zones and time/date
- The supervisory relay is activated
- The alarm relay is not activated
- Silenced alarms are not resounded
- Timers are not started
- Store event in history buffer

A typical Supervisory event would be displayed as illustrated in the following:

```

ACTIVE SUPERVISORY
  <ADJ> <NOUN>
                                Z000
10:00A 010801 1M001
  
```

Note that, like alarms, supervisory signals latch (except when programmed for supervisory autoresettable) and can be assigned to software zones. Supervisory alarms do not cause resound as do other alarm conditions. Open circuits in supervisory wiring are processed by the control panel the same way as other trouble conditions. Refer to "Alarm Operation" on page 109, for a description of the information displayed on the control panel LCD.

4.7 Process Monitor Operation

Process Monitor operation will initiate the following events:

- The piezo sounder pulses ¼ second On and ¼ second Off
- The LCD displays a process monitor message along with the device name, type, address, adjective/noun, associated zones and time/date
- Relays programmed for process monitoring will be activated
- The alarm relay is not activated
- Silenced alarms are not resounded
- Timers are not started
- Store event in history buffer

Note that, like supervisories, process monitor signals latch (except when programmed for process monitor autoresettable) and can be assigned to software zones.

4.8 Hazard Condition Operation

Hazard Condition operation will initiate the following events:

- The piezo sounder turns on steady
- The LCD displays a hazard message along with the device name, type, address, adjective/noun, associated zones and time/date
- Relays programmed for process monitoring will be activated
- The alarm relay is not activated
- Silenced alarms are not resounded
- Timers are not started
- Store event in history buffer

Hazard conditions do not latch and will therefore clear when the hazard condition is cleared. They can be assigned to software zones.

4.9 Medical Alert Condition Operation

Medical Alert Condition operation will initiate the following events:

- The piezo sounder turns on steady
- The LCD displays a medical alert message along with the device name, type, address, adjective/noun, associated zones and time/date
- Relays programmed for medical alert will be activated
- The alarm relay is not activated
- Silenced alarms are not resounded
- Timers are not started
- Store event in history buffer

Medical alert conditions do not latch and will therefore clear when the medical alert condition is cleared. They can be assigned to software zones.

4.10 NAC Operation

There are two programmable NACs (Notification Appliance Circuits) resident on the MS-9600 main circuit board. Both NACs may be programmed as silenceable or nonsilenceable and may also be programmed for steady or coded operation. Coded operation provides a choice between March Time, Temporal or California coding.

4.11 Programmed Zone Operation

Each addressable detector and monitor module can be assigned to a maximum of five software alarm zones. A general alarm zone Z00 may be listed for output (control) points, but it is not necessary to list Z00 for input points, since this is the default zone for all alarm input devices. Zone Z00 is not activated by supervisory points.

When an input device alarms and is not disabled, it activates all software zones assigned to it. An output device that is not disabled is turned on when any of the software zones to which it is programmed become active.

4.12 Disable/Enable Operation

Input points which are disabled do not cause an alarm or any zone activation. Disabled output points are held in the off state. All disabled points are treated as if they were in trouble, with the exception being the status label that will be displayed is *DISABL*.

4.13 Waterflow Circuits Operation

If an alarm exists from a monitor module point that has a waterflow type code and its mapped NAC control module outputs are programmed for nonsilenceable operation, the Alarm Silence key will not function.

4.14 Detector Functions

Maintenance Alert

Each addressable detector is monitored by the control panel for its maintenance status. If a detector is near but below the allowed alarm limit, a 'maintenance alert' message will automatically be displayed, signaling that the detector is in need of servicing.

Automatic Test Operation

An automatic test of an addressable detector is performed each minute, resulting in a complete SLC loop test in approximately 5 hours (if the loop has the maximum number of devices installed). The detector's sensing chamber and electronics are functionally tested for normal, safe operation. A trouble message is displayed upon failure of this test. A System Reset will clear this trouble.

Type Code Supervision

The FACP monitors addressable hardware device codes at slow intervals. Mismatch of any type code, compared to the system program, will cause a device trouble.

System Alarm Verification

The control panel may be programmed to perform alarm verification to help eliminate the nuisance of false alarms. Alarm verification applies to smoke detectors only.

Smoke Detector Data

Smoke detector data is monitored by the FACP, eliminating the need to test the sensitivity of each detector at its location. A printout of each detector's data can be retrieved from the FACP using an optional printer or Windows® HyperTerminal. Detector sensing ability can decrease with age and should be monitored as part of a system's routine maintenance.

4.15 Time Functions: Real-Time Clock

The MS-9600 includes a crystal-based clock that provides time of day, date and day of week. Time is displayed as 12 or 24 hour time with month/day/year and is stored in RAM. Daylight savings time change-over is programmable and automatic. If both AC and battery are lost, the time must be reset.

4.16 Synchronized NAC Operation

Synchronization is a panel feature that controls the activation of notification appliances in such a way that all devices will turn on and off at exactly the same time. This is particularly critical when activating strobes which must be synchronized to avoid random activation and a potential hazard or confusion. The FACP can be programmed to operate with a variety of manufacturer's devices.

Important: *When a Notification Appliance Circuit with a mix of audible and visual devices is programmed for silenceable and the synchronization feature is selected, only the audible devices will be turned off if the Silence key is pressed. The visual devices (strobes, etc.) will continue to operate.*

4.17 Coded Operation

The two NAC circuits resident on the control panel main circuit board can be programmed for coded operation. The available pulse rates which can be programmed for coded operation are as follows:

- Continuous: Steady output with no pulsing
- March Time: Pulses at 120 ppm (pulses per minute)
- Temporal Code: Pulses at ½ second On, ½ second Off, ½ second On, ½ second Off, ½ second On, 1½ second Off
- California Code: 10 seconds On, 5 seconds Off
- Two-Stage: Pulses at 20 ppm (pulses per minute) for 5 minutes and then changes to on steady

4.18 Presignal

Presignal option programs an initiating device to delay the activation of NACs and/or control modules while allowing visual verification by a person. Once a detector or monitor module triggers an alarm, the onboard piezo sounds immediately, but the NACs are not activated for a user programmed time duration of up to three minutes. Note that the alarm relay and communicator will respond to the initial alarm immediately. In addition, Zone 98 will activate. This zone can be programmed to a control module which may be used to activate a sounder or indicator which the installer designates as a Presignal indication. *Do not assign Zone 98 to a Notification Appliance Circuit when using this zone to indicate a Pre-signal condition.*

After the programmed delay, the NACs will activate if the source of the alarm is not cleared. Note that if a second alarm occurs during the programmed time delay, the alarm will be processed immediately, causing activation of the appropriate output zones. The events which occur upon Presignal activation are as follows:

- ✓ onboard piezo sounds immediately
- ✓ control panel LCD display will indicate a presignal event and the active point
- ✓ control points programmed to Zone 98 will activate
- ✓ annunciators (if enabled) will sound the local piezo, and pulse the alarm LED and zone LED
- ✓ outputs (NACs and control modules) of associated zones will be inhibited from activating for a user programmed time delay of up to three minutes
- ✓ second alarm occurring anytime during the time delay will cause immediate activation of all associated outputs

Presignal does not affect monitor modules programmed as waterflow, supervisory, process monitoring or remote switches. *Presignal operation requires the approval of the local Authority Having Jurisdiction.*

4.19 Positive Alarm Sequence

PAS (Positive Alarm Sequence) option will program an initiating device to delay panel activation (including alarm relay and communicator) for a period of 15 seconds. Zone 97, however, will activate immediately and may be used to connect a signaling device to indicate PAS activation. *Do not assign Zone 97 to a Notification Appliance Circuit when using this zone to indicate a PAS condition.*

When a detector or monitor module triggers an alarm, the onboard piezo sounds immediately, but the NACs are prevented from activating for 15 seconds. This inhibit time is factory set and cannot be changed. Pressing the Alarm Silence or Acknowledge/Step key during the 15 second inhibit time will silence the piezo sounder and start a timer which prevents activation of NACs for an additional time duration which can be user programmed for up to three minutes. After the programmed delay, the NACs will activate if the source of the alarm is not cleared. Note that if a second alarm occurs during either time delay, the alarm will be processed immediately, causing activation of the appropriate output zones. The events which occur upon PAS activation are as follows:

- ✓ onboard piezo sounds immediately
- ✓ control panel LCD display will indicate a presignal event and the active point
- ✓ control points programmed to Zone 97 will activate
- ✓ annunciators (if enabled) will sound the local piezo, and pulse the alarm LED and zone LED
- ✓ outputs (NACs and control modules) of associated zones will be inhibited from activating for a factory set duration of 15 seconds
- ✓ pressing the Alarm Silence or Acknowledge/Step key will start a timer which inhibits output activation for additional time delay of up to three minutes which is user programmable
- ✓ second alarm occurring anytime during either time delay will cause immediate activation of all associated outputs

PAS does not affect monitor modules programmed as waterflow, supervisory, process monitoring or remote switches. *PAS operation requires the approval of the local Authority Having Jurisdiction.*

Note that the *PAS BYPASS* monitor type code, when activated, will inhibit the PAS capability until the *PAS BYPASS* monitor is deactivated. While PAS is inhibited, signaling devices will immediately place the control panel into alarm. This feature may be employed by wiring a normally open device, such as a switch, to a monitor module which has been programmed for *PAS BYPASS*.

4.20 Special System Timers

4.20.1 Silence Inhibit Timer

This option, if selected, prevents the *Alarm Silence* key from functioning for 60 seconds following an alarm. A new alarm during the initial 60 seconds will cause the timer to restart with a new 60 seconds. *Silence Inhibit operation requires the approval of the local Authority Having Jurisdiction.*

4.20.2 Autosilence Timer

If Autosilence is selected, the notification appliances, programmed as silenceable, will automatically be silenced after a programmable duration of from 5 to 30 minutes. Pressing the *Drill* key will restart the timer. *Autosilence operation requires the approval of the local Authority Having Jurisdiction.*

4.20.3 Trouble Reminder

If selected, this feature causes a reminding ‘beep’ every 15 seconds during an alarm (after the *Alarm Silence* key is pressed) and every two minutes during a trouble condition (after the *Acknowledge/Step* or *Alarm Silence* key is pressed). The ‘beeps’ from the onboard piezo sounder will occur until the alarm or fault is cleared.

Note that if the trouble is not cleared within 24 hours, the piezo will resound, indicating that the trouble condition still exists.

4.20.4 Waterflow Retard Timer

If selected, this option will delay the activation of a waterflow type alarm for a programmable time duration from 1 to 90 seconds. This delay is in addition to any time delay inherent in the waterflow device. *This feature requires the approval of the local Authority Having Jurisdiction.*

4.20.5 Alarm Verification (None or Two Minutes)

If alarm verification is selected, an addressable smoke detector's alarm is ignored for a retard time of 13 seconds and the detector's alarm condition is automatically reset. There will be no alarm indication at the FACP during the Retard period. A confirmation period of one minute and 47 seconds follows, during which a subsequent alarm from the same detector will cause the panel to immediately activate the appropriate outputs and indicate the alarm condition at the FACP. If a different detector alarms any time during the first detector's verification period, the panel will immediately activate all appropriate outputs and indicate the alarm condition at the FACP. If no additional detector alarms occur within two minutes of the first alarm (13 second retard plus one minute and 47 second confirmation), the timer resets and the panel is ready to verify any new detector alarms which may occur.

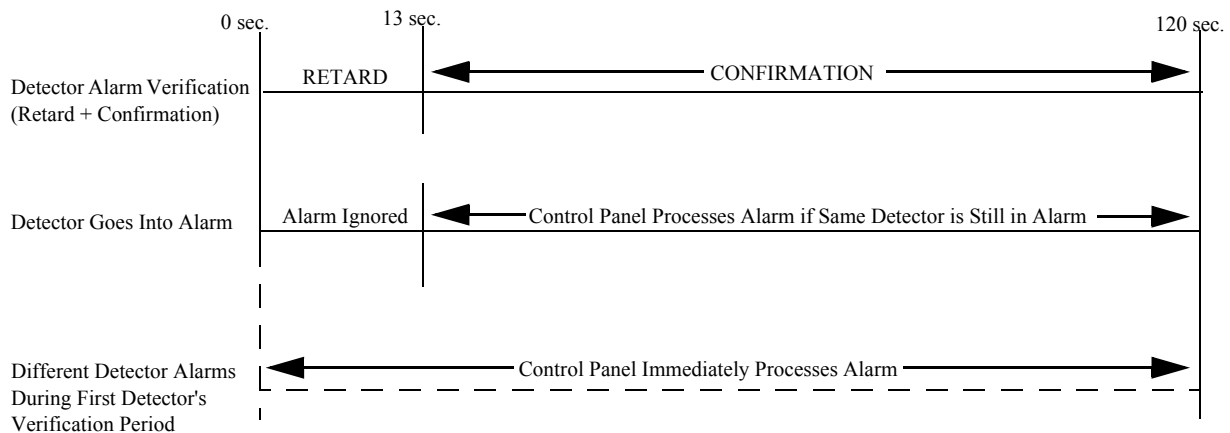

Note: Alarm Verification is available only for addressable smoke detectors, not conventional smoke detectors.

4.21 Walktest

Walktest is a feature which allows one person to test the fire alarm system. An audible walktest will momentarily sound the Notification Appliance Circuits in the building and store the walktest information in a file at the panel. A silent walktest will not sound the NACs but will store the walktest information in a file which can be viewed at the panel. Disabled NAC devices will not activate during walktest.

Alarm/Shorted Condition

When in audible Walktest, the panel responds to each new alarm and activates its programmed control outputs for four seconds, if those outputs have been programmed for silenceable activation. It also stores each alarm in the walktest history file which can be sent to an optional printer. The stored display will be the same as if the device actually activated except the colon (:) in the time stamp is replaced with an asterisk (*).

Open Condition

Addressable devices as well as both main circuit board NACs are monitored for fault conditions during Walktest mode. When a new trouble condition occurs, the FACP will activate all NACs and control modules programmed for Walktest, then shut them off after eight seconds.

While in Walktest, the trouble relay is activated and the system Trouble LED flashes (as in all of the Program and status change operations). The alarm relay is not activated.

4.22 Read Status

Read Status functions do not require a password. The control panel will continue to provide fire protection while in Read Status mode. This mode can be entered while the control panel is in alarm or trouble. If a new alarm or trouble occurs during these functions, the Read Status is exited to prevent confusion.

Read Status Entry

When the operator presses the control panel *Enter* key, the LCD will display the following:



Pressing *1*, while this screen is being displayed, will cause the control panel to enter the Read Status mode which allows the user to view and print the programmed features and status of the control panel.

The following screens will be displayed:

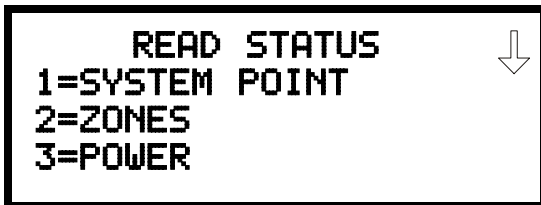

Read Status Screen #1



Read Status Screen #4

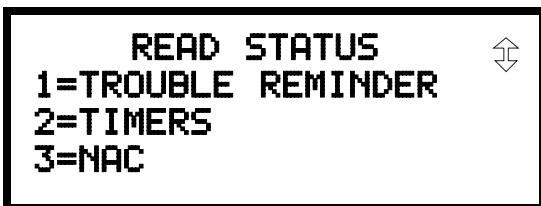

Read Status Screen #2



Read Status Screen #5

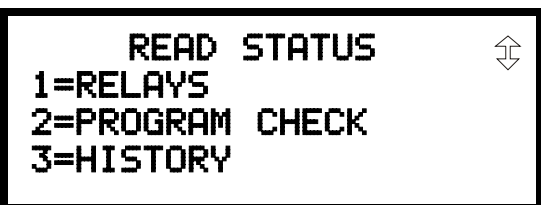

Read Status Screen #3



Read Status Screen #6

4.22.1 System Point

```

READ STATUS
1=SYSTEM POINT
2=ZONES
3=POWER

```

Read Status Screen #1

Pressing *I* while viewing Read Status Screen #1 will cause the following screen to be displayed:

```

READ SYSTEM POINT
SELECT LOOP
1=LOOP 1
2=LOOP 2

```

The operator selects the loop containing the device to be read by pressing *I* for Loop 1 or 2 for Loop 2. The following screen will then be displayed:

```

READ SYSTEM POINT
SELECT TYPE
1=DETECTOR
2=MODULE

```

The operator now selects the type of device which is to be viewed by pressing *I* for Detector or 2 for Module. If *I* is pressed, the display will change to the following screen:

```

READ SYSTEM POINT
ENTER DETECTOR#
***

```

Entering the three digit detector address will cause the control panel to display the current status of the selected device. For example, if a detector with address *001* on loop *1* is entered, a display similar to the following will appear:

```

NORMAL SMOKE(PHOTO)
NORTH CLASSROOM
                Z005
                1D001

```

The information in the preceding display includes:

- *NORMAL* - the present status (could also be ALARM, TROUBL, DISABL, etc.)
- *SMOKE (PHOTO)* - the device type which is a photoelectric smoke detector (could also be ION for ionization smoke detector)
- *NORTH CLASSROOM* - the Adjective/Noun label for this device
- *Z005* - the first of five possible assigned software zones
- *1D001* - *I* = Loop 1, *D* = Detector, *001* = Address 001

Pressing the down arrow key, while viewing the screen shown above, will allow the operator to view additional programming information about the selected device, such as:

- Enable/Disable Status
- Device Type
- Alarm Verification On/Off
- Walktest Yes/No
- PAS (Positive Alarm Sequence) Yes/No
- Pre-Signal Yes/No
- Zone Assignments (five maximum)
- Adjective/Noun descriptor

4.22.2 Zones

```

  READ STATUS
  1=SYSTEM POINT
  2=ZONES
  3=POWER

```

Read Status Screen #1

Pressing 2 while viewing Read Status Screen #1 will cause the following screens to be displayed:

```

                ZONES
  1=ZONES INSTALLED
  2=ZONES ENABLED
  3=ZONES DISABLED

```

Zones Screen #1

```

                ZONES
  1=SPECIAL PURPOSE
  2=ZONE TYPE

```

Zones Screen #2

From the preceding screens, the control panel operator can view:

- *Zones Installed* - all software zones programmed into the system (99 maximum)
- *Zones Enabled* - all software zones that are enabled
- *Zones Disabled* - all software zones that have been disabled
- *Special Purpose* - on or off programming for Special Purpose Zones 97 reserved for PAS, 98 reserved for Pre-signal and 99 reserved for future use
- *Zone Type* - the Type assigned to each installed zone (default is Alarm)

4.22.3 Power

Pressing 3 while viewing Read Status Screen #1 will cause the following screens to be displayed:

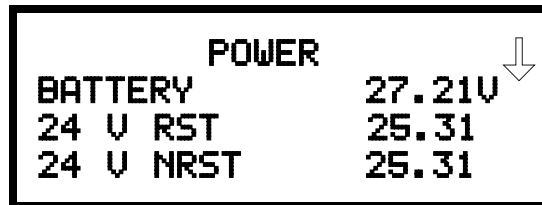

Zones Screen #1



Zones Screen #2

A real-time display of the control panel voltages can be used to determine if a problem exists in the system.

The following table lists the circuit being measured, possible conditions and their respective voltage ranges:

Circuit	Condition	Voltage Range
Battery	Normal Battery (nominal)	27.05 - 28.15 VDC
	Low Battery	20.0 - 20.8 VDC
	No Battery	0 - 18.36 VDC
24V Resettable	Normal	21.25 - 27.50 VDC
24V Nonresettable	Normal	21.25 - 27.50 VDC
Charger	Normal	27.05 - 28.15 VDC
NAC 1 or NAC 2	Normal	1.37 - 1.43 VDC
	Open Circuit	2.30 - 2.40 VDC
	Short Circuit	0 - 1.0 VDC

4.22.4 Trouble Reminder

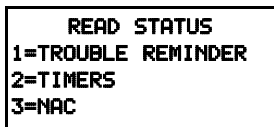

Read Status Screen #2

Pressing 1 while viewing Read Status Screen #2 will display the following screen:



The screen indicates whether the Trouble Reminder feature is On or Off.

4.22.5 Timers

Pressing 2 while viewing Read Status Screen #2 will cause the following Timer screens to be displayed:

```

          TIMERS
PAS DELAY      000
PRE SIGNAL     000
WATERFLOW     000
  
```

```

          TIMERS
AC LOSS DELAY  4
  
```

These screens will indicate the delay time, in seconds, for each of four possible delay options.

4.22.6 NAC

Pressing 3 while viewing Read Status Screen #2 will display the following screen:

```

          NAC
1=NAC 1
2=NAC 2
  
```

The operator can press 1 to view the programmed options for NAC 1 or 2 to view the programmed options for NAC 2. The resulting screens will display the following information:

- Enable/Disable Status
- Circuit Type (Bell, Strobe, etc.)
- Silenceable/Nonsilenceable
- Auto Silence Enable/Disable and time delay
- Coding Selection (Temporal, Steady, etc.)
- Zone Assignments
- Silence Inhibit Enabled/Disabled
- Synchronization Type (System Sensor, Wheelock or Gentex)

```

  READ STATUS
  1=RELAYS
  2=PROGRAM CHECK
  3=HISTORY

```

Read Status Screen #3

4.22.7 Relays

Pressing *1* while viewing Read Status Screen #3 will display the following screen:

```

          RELAY
  1=RELAY 1
  2=RELAY 2
  3=RELAY 3

```

The operator can view the programmed option for each relay by pressing the corresponding number key.

4.22.8 Program Check

Pressing *2* while viewing Read Status Screen #3 will cause a screen similar to the following to be displayed:

```

    PROGRAM CHECK
  1=NACS NO INPUT
  2=ZONES NO INPUT
  3=ZONES NO OUTPUT

```

Pressing *1* while viewing the Program Check screen will display a screen which will indicate if any input zones have not been programmed to one of the Notification Appliance Circuits. Use the up and down arrow keys to view both NACs.

Pressing *2* while viewing the Program Check screen will display a screen which will indicate if any output zones have not been programmed to at least one input zone. Use the up and down arrow keys to view all zones.

Pressing *3* while viewing the Program Check screen will display a screen which will indicate if any input zones have not been programmed to at least one output zone. Use the up and down arrow keys to view all zones.

4.22.9 History

Pressing *3* while viewing Read Status Screen #3 will display the following screen:

```

          HISTORY
  1=VIEW ALL
  2=VIEW ALARMS
  3=VIEW OTHER EVENTS

```

The operator can view all events which have been stored in the history file, only alarms or other events, such as troubles or supervisories, by pressing the corresponding number key.

4.22.10 Annunciators

```

  READ STATUS
  1=ANNUNCIATORS
  2=FUTURE USE
  3=FUTURE USE

```

Read Status Screen #4

Pressing 1 while viewing Read Status Screen #4 will display the following screens:

```

  ANNUNCIATORS
  TERM ENABLED   YES
  ACS ENABLED    YES
  UDACT ENABLED  NO

```

Annunciator Screen #1

```

  ANNUNCIATORS
  1=ACS ADDRESS

```

Annunciator Screen #2

Annunciator Screen #1 indicates if Terminal Mode, ACS Mode and UDACT options are enabled or disabled. Pressing '1' while viewing Annunciator Screen #2 allows the operator to view the ACS Mode Annunciator addresses which have been programmed into the control panel.

4.22.11 Printer/PC

```

  READ STATUS
  1=FUTURE USE
  2=PRINTER/PC
  3=PRINT

```

Read Status Screen #5

Pressing 2 while viewing Read Status Screen #5 will display the following screens:

```

  PRINTER PC
  PRINTER PC   PR4800
  START BIT
  STOP BIT

```

```

  PRINTER PC
  DATA BITS
  PARITY

```

The display will inform the operator as to whether the control panel is configured for a printer or a PC. In the example above, PR4800 indicates that the panel is configured for a printer with a baud rate of 4,800.

4.22.12 Print

```

    READ STATUS
    1=FUTURE USE
    2=PRINTER/PC
    3=PRINT
    
```

Read Status Screen #5

To print program data or control panel status, press 3 while viewing Read Status Screen #5. The following screens will be displayed:

```

                PRINT
    1=HISTORY
    2=WALKTEST LOG
    3=DETECTOR DATA
    
```

Print Screen #1

```

                PRINT
    1=EXIT PRINTING
    
```

Print Screen #2

Pressing 1 while viewing Print Screen #1 allows the user to print the History file which will detail all of the system activities since the file was last cleared from memory.

Pressing 2 while viewing Print Screen #1 allows the user to print the Walktest log which will detail all of the system activations during walktest since the log was last cleared. Refer to "Walktest" on page 90 for additional information on the display.

Pressing 3 while viewing Print Screen #1 allows the user to print the detector data for each addressable smoke detector connected to the system. A printout, similar to the following example, will be generated if an optional printer is connected to the FACP.

DEVICE#	DEVICE TYPE	%DRIFT COMP	CHAMBER	TIME/DATE
1D001	SMOKE (PHOTO)	20	1281	12:01AM 01-08-2001
1D002	SMOKE (PHOTO)	20	1281	12:01AM 01-08-2001
1D003	SMOKE (PHOTO)	21	1259	12:01AM 01-08-2001
1D004	SMOKE (PHOTO)	20	1309	12:02AM 01-08-2001
1D005	SMOKE (PHOTO)	21	1281	12:02AM 01-08-2001
1D006	SMOKE (PHOTO)	20	1322	12:02AM 01-08-2001
1D007	SMOKE (PHOTO)	20	1280	12:02AM 01-08-2001
1D008	SMOKE (PHOTO)	20	1215	12:02AM 01-08-2001
1D009	SMOKE (PHOTO)	20	1310	12:02AM 01-08-2001

Chamber Value

The Chamber value should be within the indicated range for the following smoke detectors:

- SD350(T), D350P(R) and SD300(T) Addressable Photoelectric Smoke Detectors: **405 - 2100** (obscuration of 1.00%/ft to 3.66%/ft.)
- CP350 and CP300 Addressable Ionization Smoke Detectors: **750 - 2100** (obscuration of 0.50%/ft. to 1.44%/ft.)

If the addressable smoke detector's Chamber reading is not within the acceptable range, clean the detector and check the Chamber value again. If the reading is still not within the acceptable range, immediately replace the detector.

Drift Compensation

Drift compensation uses software algorithms that identify and compensate for long-term changes in the data readings from each addressable smoke detector. These long-term changes in detector data readings are typically caused by dirt and dust accumulation inside the smoke chamber. Drift compensation performs the following functions:

- Allows a smoke detector to retain its original ability to detect actual smoke and resist false alarms, even as dirt and dust accumulate
- Reduces maintenance requirements by allowing the control panel to automatically perform the periodic sensitivity measurements required by NFPA Standard 72

The FACP software also provides filters to remove transient noise signals, usually caused by electrical interference.

Maintenance Alert

The software determines when the drift compensation for a detector reaches an unacceptable level that can compromise detector performance. When a detector reaches an unacceptable level, the control panel indicates a maintenance alert. Table 4.1 summarizes the three levels of maintenance alert:

Maintenance Level	FACP Status Displays	Indicates
Low Chamber Value	INUREP	A hardware problem in the detector
Maintenance Alert	DIRTY1	Dust accumulation that is near but below the allowed limit. <i>DIRTY 1</i> indicates the need for maintenance before the performance of the detector is compromised
Maintenance Urgent	DIRTY2	Dust accumulation above the allowed limit.

Table 4.1 Maintenance Alert Levels

Figure 4.1 illustrates a graphic representation of the maintenance levels:

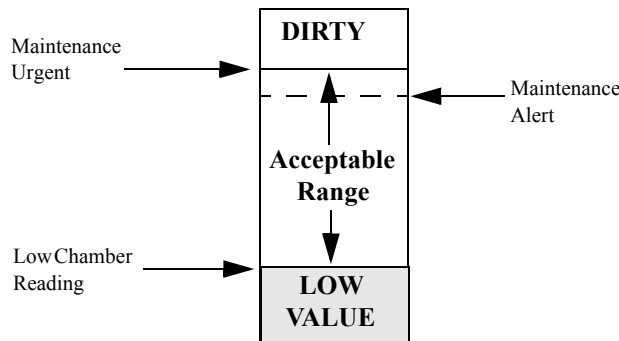

Figure 4.1 Diagram of Maintenance Levels

4.22.13 Time-Date

```

    READ STATUS
    1=TIME-DATE
    
```

Read Status Screen #6

The operator can view the daylight savings time and the month and week when daylight savings time will begin and end. Pressing 1 while viewing Read Status Screen #6 will display the following screens:

```

    DAYLIGHT SAVINGS
    ENABLED          YES
    START MONTH     APR
    START WEEK      WEEK-1
    
```

```

    DAYLIGHT SAVINGS
    END MONTH       OCT
    END WEEK        LAST-W
    
```

SECTION 5 Power Supply Calculations

5.1 Overview

This section contains instructions and tables for calculating power supply currents in alarm and standby conditions. This is a four-step process, consisting of the following:

1. Calculating the total amount of AC branch circuit current required to operate the system
2. Calculating the power supply load current for non-fire and fire alarm conditions and calculating the secondary (battery) load
3. Calculating the size of batteries required to support the system if an AC power loss occurs
4. Selecting the proper batteries for your system

5.2 Calculating the AC Branch Circuit

The control panel requires connection to a separate, dedicated AC branch circuit, which must be labeled **FIRE ALARM**. This branch circuit must connect to the line side of the main power feed of the protected premises. No other non-fire alarm equipment may be powered from the fire alarm branch circuit. The branch circuit wire must run

continuously, without any disconnect devices, from the power source to the control panel. Overcurrent protection for this circuit must comply with Article 760 of the National Electrical Codes as well as local codes. Use 14 AWG (2.00 mm²) wire with 600 volt insulation for this branch circuit.

Use Table 5.1, to determine the total amount of current, in AC amperes (A), that must be supplied to the system.

Table 5.1 AC Branch Circuit Requirements

Device Type	Number of Devices		Current Draw (AC amps)		Total Current per Device
MS-9600			3.2		
or	1	X	or	=	
MS-9600E			1.6		
CHG-120F	[]	X	2.0	=	
	[]	X	[]	=	
Sum Column for AC Branch Current Required				=	

5.3 Calculating the System Current Draw

5.3.1 Overview

The control panel must be able to power all internal and external devices continuously during the non-fire alarm condition. To calculate the non-fire alarm load on the system power supply when primary power is applied, use Calculation Column 1 in Table 5.3 on page 129. The control panel must support a larger load current during a fire alarm condition. To calculate the fire alarm load on the power supply, use Calculation Column 2 in Table 5.3 on page 129. The secondary power source (batteries) must be able to power the system during a primary power loss. To calculate the non-fire alarm load on the secondary power source, use Calculation Column 3 in Table 5.3 on page 129.

When calculating current draw and the battery size, note the following:

- ‘Primary’ refers to the main power source for the control panel
- ‘Secondary’ refers to the control panel’s backup batteries
- All currents are given in amperes (A). Table 5.2 shows how to convert milliamperes and microamperes to full amperes.

Table 5.2 Converting to Full Amperes

To convert...	Multiply	Example
Milliamperes (mA) to amperes (A)	mA x 0.001	3 mA x 0.001 = 0.003A
Microamperes (μA) to amperes (A)	μA x 0.000001	300 μA x 0.000001 = 0.0003 A

5.3.2 How to Use Table 5.3 on page 129 to Calculate System Current Draw

Use Table 5.3 on page 129 to calculate current draws as follows:

1. Enter the quantity of devices in all three columns
2. Enter the current draw where required. Refer to the Fire-Lite Device Compatibility Document for compatible devices and their current draw
3. Calculate the current draws for each in all columns
4. Sum the total current for each column
5. Copy the totals from Column 2 and Column 3 to Table 5.4 on page 130

Following are the types of current that can be entered into Table 5.3 on page 129:

- ✓ **Calculation Column 1** - The primary supply current load that the control panel must support during a non-fire alarm condition, with AC power applied.
- ✓ **Calculation Column 2** - The primary supply current load that the control panel must support during a fire alarm condition, with AC power applied.
- ✓ **Calculation Column 3** - The standby current drawn from the batteries in a non-fire alarm condition during a loss of AC power.

Table 5.3 contains columns for calculating current draws. For each column, calculate the current and enter the total (in amperes) in the bottom row. When finished, copy the totals from Calculation Column 2 and Calculation Column 3 to Table 5.4 on page 130.

Table 5.3 System Current Draw Calculations

Device Type	Calculation Column 1 Primary, Non-Fire Alarm Current (amps)			Calculation Column 2 Primary, Fire Alarm Current (amps)			Calculation Column 3 Secondary, Non-Fire Alarm Current (amps)		
	Qty	X[current draw]=	Total	Qty	X [current draw] =	Total	Qty	X[current draw]=	Total
Main Circuit Board	1	X[0.150]=	0.150	1	X[0.170]=	0.170	1	X[0.120]=	0.120
SLC-2 Expander Module	[]	X[0.085]=		[]	X[0.085]=		[]	X[0.085]=	
ACM-8RF	[]	X[0.030]=		[]	X[0.158] ¹ =		[]	X[0.030]=	
ACM-16ATF									
ACM-32AF	[]	X[0.040]		[]	X[0.056] ² =		[]	X[0.040]=	
AEM-16ATF									
AEM-32AF	[]	X[0.002]		[]	X[0.018] ² =		[]	X[0.002]=	
AFM-16ATF									
AFM-32AF	[]	X[0.040]		[]	X[0.056] ² =		[]	X[0.040]=	
AFM-16AF	[]	X[0.025]		[]	X[0.065] ² =		[]	X[0.025]=	
UDACT-F	[]	X[0.040]		[]	X[0.075] ³ =		[]	X[0.040]=	
LDM-32F	[]	X[0.040]		[]	X[0.056] ⁴ =		[]	X[0.040]=	
LDM-E32F	[]	X[0.002]		[]	X[0.018]=		[]	X[0.002]=	
LCD-80F	[]	X[0.064]		[]	X[0.064]=		[]	X[0.025]=	
4XTMF	[]	X[0.005]=		[]	X[0.011] ⁵ =		[]	X[0.005]=	
4-wire Detector Heads	[]	X[] ⁶ =		[]	X[]=		[]	X[]=	
Power Supervision Relays ⁷	[]	X[0.025]=		[]	X[0.025]=		[]	X[0.025]=	
CP350	[]	X[0.00030]=					[]	X[0.00030]=	
SD350	[]	X[0.00030]=					[]	X[0.00030]=	
SD350T	[]	X[0.00030]=					[]	X[0.00030]=	
H350	[]	X[0.00030]=					[]	X[0.00030]=	
H350R	[]	X[0.00030]=					[]	X[0.00030]=	
D350P	[]	X[0.00030]=					[]	X[0.00030]=	
D350RP	[]	X[0.00030]=					[]	X[0.00030]=	
B501BH & B501BHT ⁸	[]	X[0.001]=					[]	X[0.001]=	
B224RB Relay Base	[]	X[0.00050]=					[]	X[0.00050]=	
B224BI Isolator Base	[]	X[0.00045]=					[]	X[0.00045]=	
MMF-300	[]	X[0.00040]=					[]	X[0.00040]=	
MDF-300	[]	X[0.00075]=					[]	X[0.00075]=	
MMF-301	[]	X[0.000375]=					[]	X[0.000375]=	
MMF-302	[]	X[0.00027]=					[]	X[0.00027]=	
BG-12LX	[]	X[0.00023]=					[]	X[0.00023]=	
CMF-300	[]	X[0.00039]=					[]	X[0.00039]=	
CRF-300	[]	X[0.00027]=					[]	X[0.00027]=	
I300	[]	X[0.00040]=					[]	X[0.00040]=	
NAC #1 ⁹				[]	X[]=				
NAC #2				[]	X[]=				
Current Draw from TB3 (nonalarm) ¹⁰	[]	=		[]	[]=		[]	[]=	
Sum each column¹¹ for totals		Primary Non-Alarm =			Primary Alarm =			Secondary Alarm =	

Table Footnote

1. All eight ACM-8RF relays activated on a single module.
2. All annunciator LEDs on
3. UDACT-F actively making phone call to central station. If the normally open contact is used, current consumption increases to 100 mA.
4. LDM-32F with LEDs on
5. If using the Reverse Polarity Alarm output, add 0.005 amps; if using the Reverse Polarity Trouble output, add another 0.005 amps.
6. Refer to the Device Compatibility Document for standby current.
7. Must use compatible listed Power Supervision Relay.
8. Maximum alarm current for each sounder base is 0.015 amps which must be supplied by aux. 24VDC source.
9. Current limitation of Terminal TB4 circuits is 3.00 amps per NAC.
10. The total standby current must include both the resettable (TB3 Terminals 1 & 2) and nonresettable (TB3 Terminals 3 & 4, 5 & 6) power. Caution must be taken to ensure that current drawn from these outputs during alarm does not exceed maximum ratings specified. Current limitations of TB3 circuits is 3.0 amps per output
11. Total current draw listed above cannot exceed 7.2 amps.

5.4 Calculating the Battery Size

Use Table 5.4 to calculate the total Standby and Alarm load in ampere hours (AH). This total load determines the battery size (in AH), required to support the control panel under the loss of AC power. Complete Table 5.4 as follows:

1. Enter the totals from Table 5.3 on page 129, Calculation Columns 2 and 3 where shown
2. Enter the NFPA Standby and Alarm times (refer to ‘NFPA Requirements’ below)
3. Calculate the ampere hours for Standby and Alarm, then sum the Standby and Alarm ampere hours
4. Multiply the sum by the derating factor of 1.2 to calculate the proper battery size (in AH)
5. Write the ampere hour requirements on the Protected Premises label located inside the cabinet door

Table 5.4 Total Secondary Power Requirements at 24 VDC

Secondary Standby Load (total from Table 5.3 Calculation Column 3) []	Required Standby Time (24 or 60 hours) X[]	= AH
Primary Alarm Load (total from Table 5.3 Calculation Column 2) []	Required Alarm Time (for 5 min., enter 0.084, for 10 min., enter 0.168) X[]	= AH
Sum of Standby and Alarm Ampere Hours		= AH
Multiply by the Derating Factor		X 1.2
Battery Size, Total Ampere Hours Required		= AH

5.4.1 NFPA Battery Requirements

- NFPA 72 Local and Proprietary Fire Alarm Systems require 24 hours of standby power followed by 5 minutes in alarm
- NFPA 72 Central, Auxiliary and Remote Station Fire Alarm Systems require 60 hours of standby followed by 5 minutes in alarm. Batteries installed in a system powered by a generator need to provide at least 4 hours of standby power
- NFPA requires 24 hours of standby plus 15 minutes activation for audio systems. The total ampere hours required cannot exceed 25 AH with an internal charger

5.4.2 Selecting and Locating Batteries

Select batteries that meet or exceed the total ampere hours calculated in Table 5.4. The control panel can charge batteries in the 7 AH to 25 AH range. The control panel cabinet is capable of housing batteries up to 18 AH. Batteries larger than 18 AH require the BB-25F, BB-55F or other UL listed external battery cabinet.

APPENDIX A Software Zones

A.1 Correlations

Setup and configuration of an addressable system is different than a conventional system. In a conventional system, assignment of input devices (smoke detectors, pull stations, heat detectors, etc.) to zones is accomplished through wiring. The wiring is direct from clearly marked panel terminals to any device assigned to a particular zone. Connection of output devices (horns, bells, strobes, etc.) in a conventional system is accomplished by direct wiring of the output devices to Notification Appliance Circuit terminals.

In an addressable system, a minimum of a single pair of wires (SLC communication loop) is used to connect all addressable input and output devices. Communications between the FACP (Fire Alarm Control Panel) and all addressable devices takes place over the wire pair which originates from the FACP. Software programming is used to configure the system as opposed to direct wiring. Zone assignments are created via software means, hence the term *software zones*.

Setup of an MS-9600 software zone is accomplished by panel programming. Each addressable device can be assigned to a maximum of five software zones. Each software zone, however, may have from 1 to 99¹ addressable input devices assigned to it and from 1 to 99¹ addressable output devices assigned to it.

Monitor and control modules comprise one group of 99¹ addresses, with each module having a unique address from 1 to 99¹. Detectors comprise a separate group of 99¹ addresses, each detector having a unique address from 1 to 99¹ in its group. Be careful not to duplicate addresses within any one group (modules and detectors). Refer to the following page for an example of zoning.

In the example on the following page:

- Zone 01 has the following addressable devices assigned to it:
 - ✓ SD350 smoke detectors with addresses 01 and 02
 - ✓ MMF-300 monitor module with address 01
 - ✓ MMF-302 monitor module with address 02 and 03
 - ✓ CMF-300 control modules with addresses 05, 06, 07, 09 and 13
- Zone 02 has the following addressable devices assigned to it:
 - ✓ MMF-302 monitor module with addresses 02 and 03
 - ✓ CP350 smoke detectors with addresses 03 and 04
 - ✓ CMF-300 control modules with addresses 08, 09 and 10
- Zone 03 has the following addressable devices assigned to it:
 - ✓ SD350 smoke detectors with addresses 05, 06 and 07
 - ✓ MMF-302 control module with address 04
 - ✓ CMF-300 control modules with addresses 09, 11 and 12

The example points out some of the key assignment features of the MS-9600. Addresses of detectors are not duplicated. Addresses of monitor and control modules are not duplicated. The control module with address 09 is assigned to three software zones (providing floor above and floor below). Be careful to properly plan the installation prior to installing any devices.

¹*CLIP or Classic Loop Interface Protocol devices (modules and detectors) can only have unique addresses of 1 to 99. Newer modules can have unique addresses of 1 to 159 which means each zone can have up to 159 input and output devices assigned to it.*

Correlation of Input and Output Zones

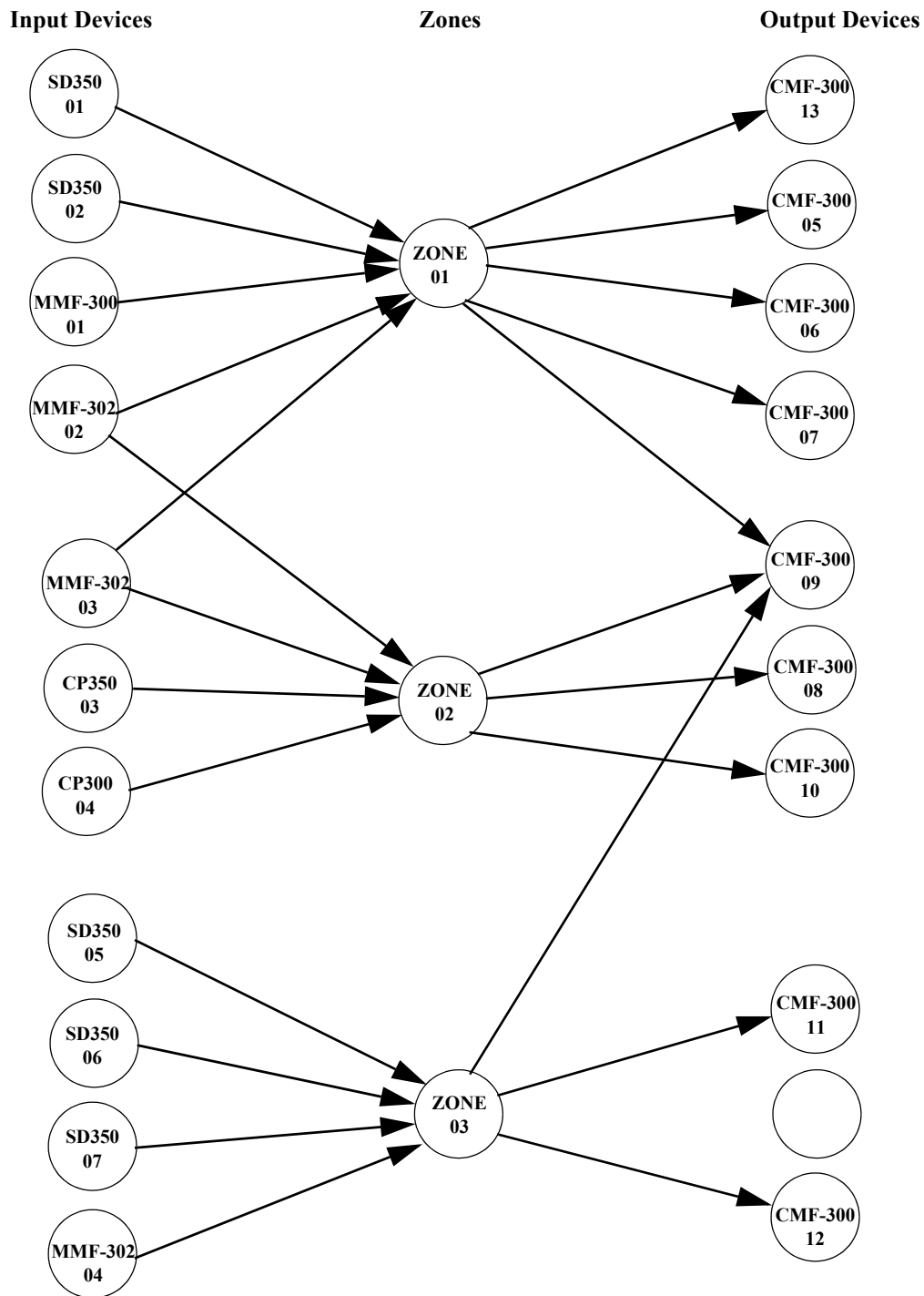

The zone correlations which are shown graphically above are also presented in Table A.1 on page 133 and Table A.2 on page 134.

Table A.1 Detector Programming Sheet Example

DETECTOR ZONE ASSIGNMENT							
Address	Device Type	Zone Number	ADJ/NOUN	Address	Device Type	Zone Number	ADJ/NOUN
01	SD350	1	FIRST HALL	51			
02	SD350	1	ELEV. LOBBY	52			
03	CP350	2	2ND FLOOR	53			
04	CP350	2	ROOM 210	54			
05	SD350	3	3RD FLOOR	55			
06	SD350	3	MEZZANINE	56			
07	SD350	3	MECH. ROOM	57			
08				58			
09				59			
10				60			
11				61			
12				62			
13				63			
14				64			
15				65			
16				66			
17				67			
18				68			
19				69			
20				70			
21				71			
22				72			
23				73			
24				74			
25				75			
26				76			
27				77			
28				78			
29				79			
30				80			
31				81			
32				82			
33				83			
34				84			
35				85			
36				86			
37				87			
38				88			
39				89			
40				90			
41				91			
42				92			
43				93			
44				94			
45				95			
46				96			
47				97			
48				98			
49				99			
50				100			

Table A.2 Module Programming Sheet Example

MONITOR/CONTROL MODULE ZONE ASSIGNMENT							
Address	Device Type	Zone Number	ADJ/NOUN	Address	Device Type	Zone Number	ADJ/NOUN
01	MMF-300	1		51			
02	MMF-302	1, 2		52			
03	MMF-302	1, 2		53			
04	MMF-302	3		54			
05	CMF-300	1		55			
06	CMF-300	1		56			
07	CMF-300	1		57			
08	CMF-300	2		58			
09	CMF-300	1, 2, 3		59			
10	CMF-300	2		60			
11	CMF-300	3		61			
12	CMF-300	3		62			
13	CMF-300	1		63			
14				64			
15				65			
16				66			
17				67			
18				68			
19				69			
20				70			
21				71			
22				72			
23				73			
24				74			
25				75			
26				76			
27				77			
28				78			
29				79			
30				80			
31				81			
32				82			
33				83			
34				84			
35				85			
36				86			
37				87			
38				88			
39				89			
40				90			
41				91			
42				92			
43				93			
44				94			
45				95			
46				96			
47				97			
48				98			
49				99			
50				100			

Table A.3 Blank Detector Programming Sheet - 1 of 2

DETECTOR ZONE ASSIGNMENT							
Address	Device Type	Zone Number	ADJ/NOUN	Address	Device Type	Zone Number	ADJ/NOUN
01				51			
02				52			
03				53			
04				54			
05				55			
06				56			
07				57			
08				58			
09				59			
10				60			
11				61			
12				62			
13				63			
14				64			
15				65			
16				66			
17				67			
18				68			
19				69			
20				70			
21				71			
22				72			
23				73			
24				74			
25				75			
26				76			
27				77			
28				78			
29				79			
30				80			
31				81			
32				82			
33				83			
34				84			
35				85			
36				86			
37				87			
38				88			
39				89			
40				90			
41				91			
42				92			
43				93			
44				94			
45				95			
46				96			
47				97			
48				98			
49				99			
50				100			

Table A.4 Blank Detector Programming Sheet - 2 of 2

DETECTOR ZONE ASSIGNMENT							
Address	Device Type	Zone Number	ADJ/NOUN	Address	Device Type	Zone Number	ADJ/NOUN
101				151			
102				152			
103				153			
104				154			
105				155			
106				156			
107				157			
108				158			
109				159			
110							
111							
112							
113							
114							
115							
116							
117							
118							
119							
120							
121							
122							
123							
124							
125							
126							
127							
128							
129							
130							
131							
132							
133							
134							
135							
136							
137							
138							
139							
140							
141							
142							
143							
144							
145							
146							
147							
148							
149							
150							

Table A.5 Blank Module Programming Sheet - 1 of 2

MONITOR/CONTROL MODULE ZONE ASSIGNMENT							
Address	Device Type	Zone Number	ADJ/NOUN	Address	Device Type	Zone Number	ADJ/NOUN
01				51			
02				52			
03				53			
04				54			
05				55			
06				56			
07				57			
08				58			
09				59			
10				60			
11				61			
12				62			
13				63			
14				64			
15				65			
16				66			
17				67			
18				68			
19				69			
20				70			
21				71			
22				72			
23				73			
24				74			
25				75			
26				76			
27				77			
28				78			
29				79			
30				80			
31				81			
32				82			
33				83			
34				84			
35				85			
36				86			
37				87			
38				88			
39				89			
40				90			
41				91			
42				92			
43				93			
44				94			
45				95			
46				96			
47				97			
48				98			
49				99			
50				100			

Table A.6 Blank Module Programming Sheet - 2 of 2

MONITOR/CONTROL MODULE ZONE ASSIGNMENT							
Address	Device Type	Zone Number	ADJ/NOUN	Address	Device Type	Zone Number	ADJ/NOUN
101				151			
102				152			
103				153			
104				154			
105				155			
106				156			
107				157			
108				158			
109				159			
110							
111							
112							
113							
114							
115							
116							
117							
118							
119							
120							
121							
122							
123							
124							
125							
126							
127							
128							
129							
130							
131							
132							
133							
134							
135							
136							
137							
138							
139							
140							
141							
142							
143							
144							
145							
146							
147							
148							
149							
150							

APPENDIX B Default Programming

The following table provides a list of the programming options and their factory default settings.

Program Option	Factory Default	Program Option	Factory Default
Detector Programming	Not Installed	Daylight Savings	Yes
Detector Type	Smoke-Photo	Month Start Daylight Savings	April
Detector Verification	Off	Week Start Daylight Savings	1st Week
Detector Walktest	Yes	Month End Daylight Savings	October
Detector PAS	No	Week End Daylight	Last Week
Detector Presignal	No	Verification	No
Detector Zone Assign.	000 only	(future)	
Detector Adj/Noun	none	PAS Timer	0
Module Programming	Not Installed	Presignal Timer	0
Module Type	Monitor	Waterflow Retard Timer	0
Module Walktest	Yes	NAC 1 & 2 Enable	Enabled
Module PAS	No	NAC 1 & 2 Silenceable	Yes
Module Presignal	No	NAC 1 & 2 Type	Bell
Module Zone Assign.	000 only	NAC 1 & 2 Sync Type	System Sensor
Module Adj/Noun	none	NAC 1 & 2 Autosilence	0
Zone 0 Enable	Enabled	NAC 1 & 2 Coding	Steady
Zone 1 Enable	Enabled	NAC 1 & 2 Zones	Zone 000 only
Zone 2 Enable	Enabled	NAC 1 & 2 Silence Inhibit	0
Zone 3 Enable	Enabled	Relay 1	Alarm
.....through.....	Relay 2	Trouble
Zone 96 Enable	Enabled	Relay 3	Supervisory
Zones 97, 98 & 99	Enabled	(future)	No
(future)		Annunciator Terminal Mode	No
Loop 1 & 2 Style	Style 4	Annunciator ACS Mode	
Loop 1 & 2 Protocol	CLIP	UDACT	No
Trouble Reminder	Off	ACS Installed	No
Banner	Fire•Lite	Printer-PC	No
Time Format	12 Hr	Printer Baud	9600
Hours Setting	12		
Minutes Setting	00		
Second Settings	00		
AM-PM Setting	AM		
Month Setting	01		
Day Setting	01		
Year Setting	00		

APPENDIX C Wire Requirements

T-tapping of the SLC loop wiring is allowed for 2-wire (Style 4) configurations. The total resistance of any branch cannot exceed 40 ohms. The total wire length of all branches cannot exceed 10,000 feet (3,000 m).

Connecting external system accessories to the MS-9600 main circuits must be carefully considered to ensure proper operation. It is important to use the correct type of wire, wire gauge and wire run length for each MS-9600 circuit. Reference the chart below to specify wire requirements and limitations for each MS-9600 circuit.

Note: If the SLC loop is to be run in conduit with Notification Appliance Circuits, the risk of encountering problems can be greatly reduced by exclusively employing electronic sounders (such as MA/SS-24D) instead of more electronically noisy notification appliances such as electromechanical bells or horns.

Table C.1 MS-9600 Wire Specifications

CIRCUIT CONNECTIONS		WIRE REQUIREMENTS		
Circuit Type	Circuit Function	Wire Type and Limitations	Recommended Max. Distance Feet (meters)	Wire Gauge and Compatible Brands
SLC loop (power-limited)	Connects to Addressable Devices	Twisted, shielded pair, 40 ohms maximum per length of Style 6 and 7 loops. 40 ohms per branch maximum for Style 4 loops ¹	10,000 (3,000 m) 8,000 (2,400 m) 4,875 (1,450 m) 3,225 (980 m)	12 AWG (3.25 mm ²): Genesis 4410, Signal 98230, Belden 9583, WPW999 14 AWG (2.00 mm ²): Genesis 4408 & 4608, Signal 98430, Belden 9581, WPW995 16 AWG (1.30 mm ²): Genesis 4406 & 4606, Signal 98630, Belden 9575, WPW991 <u>Direct Burial Cable</u> Isotec NP713110VNQ-S 18 AWG (0.75 mm ²): Genesis 4402 & 4602, Signal 98300, Belden 9574, WPW975 <u>Direct Burial Cable</u> Isotec NP714110VNQ-S
		Untwisted, unshielded pair	3,000 (900 m)	12-18 AWG (3.25 - 0.75 mm ²)
ACS/TERM (EIA-485) (power-limited)	Connects to annunciator modules and UDACT-F	Twisted, shielded pair with a characteristic impedance of 120 ohms	6,000 (1,800 m)	18 AWG (0.75 mm ²)
EIA-232 (power-limited)	connects to remote printer and PC computer	Twisted, shielded pair	50 (15 m)	18 AWG (0.75 mm ²) minimum
MMF-300 and MMF-301 (power-limited)	Initiating Device Circuit	Maximum loop wire resistance is 40 ohms for the MMF-300 and 20 ohms for the MMF-301	2,500 (760 m)	12-18 AWG (3.25 - 0.75 mm ²)
MMF-302 (power-limited)	Initiating Device Circuit	No more than a 2.4 volt drop allowed at end of circuit. Maximum loop wire resistance is 25 ohms	2,500 (760 m)	12-18 AWG (3.25 - 0.75 mm ²)
CMF-300 (power-limited)	Notification Appliance Circuit	In alarm, no more than a 1.2 volt drop allowed at end of circuit	Distance limitation set by 1.2 volt maximum line drop	12-18 AWG (3.25 - 0.75 mm ²)
24 VDC filtered resettable (power-limited)	Connects to 4-wire smoke detectors	No more than 1.2 volt drop allowed from supply source to end of any branch	Distance limitation set by 1.2 volt maximum line drop	12-18 AWG (3.25 - 0.75 mm ²)
24 VDC nonresettable (power-limited)	Connects to control modules, annunciators and accessories	No more than 1.2 volt drop allowed from supply source to end of any branch	Distance limitation set by 1.2 volt maximum line drop	12-18 AWG (3.25 - 0.75 mm ²)
CHG-120F	Remote secondary power source	12 AWG (3.25 mm ²) in conduit	20 (6 m)	12-18 AWG (3.25 - 0.75 mm ²)

Table Footnote

1. When using untwisted, unshielded wire, full conduit is recommended for optimum EMI/RFI protection.

Index

Numerics

- 300 Series addressable devices 20
- 4XTMF module
 - coil resistance 31
 - current 31
 - installation 31
 - installation steps 32
 - see also Transmitter Module 13, 20
 - voltage 31

A

- AC Branch Circuit
 - calculations 127
- AC Loss Delay 81
- AC Power 27
 - current 14
 - current, maximum 27
 - voltage 14
 - wiring 14, 27
- Acknowledge/Step 16, 105
- ACM 22
- ACM LED annunciator 37
- ACM Series
 - see also annunciator 22
- ACM-16ATF Annunciator 22
- ACM-32AF Annunciator 22
- ACM-8RF 13
 - contact rating 35
 - mounting to BRKT-9600 36
 - see also Relay Control Module 35
- ACS LED annunciator 13
- add Detector 43
- add Module 53
- address range 19
- addressable 12
- addressable detectors
 - see also detectors 13
- Addressable Device Accessories 20
- addressable modules 19
 - see also modules 13
- addressing
 - annunciators 37
 - see also device addressing 74
 - see also module or detector addressing 19
- Adjective
 - control module 67
 - monitor module 60
 - multiple entries 52
- Adjective list 50
- AEM-16ATF Annunciator 22
- AEM-32AF Annunciator 22
- AFM annunciator 37
- AFM-16AF Annunciator 22
- AFM-16ATF Annunciator 22
- AFM-32AF Annunciator 22

- Alarm 109
 - Alarm Silence 16, 105
 - alarm verification 13, 47, 112, 116
 - annunciator 22
 - ACM 13, 37
 - ACM-8RF 13
 - LCD-80F 13
 - LDM Graphic 13
 - annunciator addressing 37
 - annunciator, graphic
 - see also LDM Series 23
 - annunciator, remote
 - see also LCD-80F 23
 - Auto Silence
 - NAC 84
 - Automatic Test Operation 112
 - Autoprogramming 13, 39, 87
 - Autosilence 13, 115
 - auxiliary DC power 27
 - Auxiliary Trouble Input 17, 32
- ## B
- backbox 18
 - see also cabinet 26
 - Banner 75
 - Banner setting 76
 - battery 18
 - cable connection 27
 - charger 17
 - charger capacity 14
 - Charging Circuit 14
 - see also secondary power 14, 27
 - battery box 21, 22
 - battery charger 22
 - disable 14
 - external 22
 - baud rate 92
 - BB-17F
 - see also battery box 21
 - BB-55F
 - see also battery box 18, 22
 - BG-10LX
 - see also manual pull station 20
 - BG-12LX
 - see also manual pull station 19
 - BRKT-9600
 - bracket installation 35, 36
 - see also Universal Bracket 35
- ## C
- C304 Control/Relay Module 20
 - cabinet 18
 - dimensions 25, 26
 - cabinet mounting 24
 - Calculate System Current Draw 128
 - Calculating the Battery Size 130
 - CHG-120F
 - see also battery charger 22

- see also remote battery charger 14
 - Clasic Loop Interface Protocol 74
 - Class A 19, 28
 - Class B 19, 28
 - Classic Loop Interface Protocol 19
 - CLIP Mode
 - see also Classic Loop Interface Protocol 19
 - CLIP mode
 - see also Classic Loop Interface Protocol 74
 - Clock Format 78
 - CMF-300 control module 19
 - Coded Operation 113
 - Coding
 - NAC 84
 - Control Buttons 105
 - control module 19
 - description display 69
 - display 63
 - edit 63
 - enable/disable 64
 - noun 68
 - noun/adjective 66, 67
 - silenceable 65
 - type 65
 - type codes 65
 - Correlations 131
 - CP300 Ionization Detector 20
 - CP350 18
 - CRF-300 relay module 19
 - current
 - AC Power 27
 - availability 15
 - maximum 15
 - Current Draw Calculations 129
- ## D
- D350P 18
 - D350R 18
 - data
 - see also detector data and sensitivity 112
 - Data Entry
 - via computer keyboard 38
 - via keypad 38
 - data values
 - see also detector data and sensitivity 12
 - Date setting 78
 - Daylight Savings Time 78
 - DC power
 - nonresettable 27
 - resettable 27
 - see also auxiliary DC power 27
 - Default Programming 139
 - Delete Detector 44

Index

- Delete Module 54
- Description
 - control module 69
 - detector label 52
 - monitor module 62
- Detector 13
 - add 43
 - adding description 49
 - delete 44
 - edit 44
 - enable/disable 46
 - screen display 45
 - type 47
 - verification 47
- Detector Annunciator 19
- detector data 112, 124, 125
 - acceptable range 124
 - printout 124
- Detector Programming 43
- device addressing 74
- Digital Alarm Communicator/
Transmitter
 - see also UDACT-F 35
- dimensions
 - cabinet 25
- DIRTY1 125
- DIRTY2 125
- Disable 71
- Disable Point
 - Maintenance Level 98
- dress panel 18, 21
- drift compensation 12, 125
 - definition 125
- Drill 16, 105
- E**
- earth ground 27
- edit
 - control module 63
 - detector 44
 - detector screens 45
 - module, monitor 55
- EIA-232 34
 - for PC/Printer connection 15
 - see also Printer/PC interface 12
- EIA-485
 - for ACS annunciators 15
 - for LCD-80F 15
- Enable 70
- Enable/Disable
 - control module 64
 - detector 46
 - module, monitor 57
- End-of-Line Resistor Assembly 20
- Enter key 41
- Erase History 89
- exiting
 - programming 39, 40
- Read Status 39, 40
- Expander Module 33
 - see also SLC-2 20
- F**
- FACP
 - see also Fire Alarm Control Panel 12
- Features 12
- Fire Alarm Control Panel
 - see also FACP 12
- Form-C relay 17, 28, 35
- G**
- general alarm zone 59
 - see also zone Z00 49
- ground fault 34
- H**
- H350 18
- H350R 18
- Hazard Condition 111
- History 88
 - erase 89
 - Maintenance Level 99
 - view events 89
- History file 12
- I**
- I300
 - see also Isolator Module 19
- Indicators 16
- Installation 24
- intelligent 12
- Inventory 12
- INVREP 125
- Isolator Module 19
- K**
- Key Panel 16
 - function keys 16
 - service/program keys 16
- keyboard and keypad 38
- Keypad/Display
 - removal and installation 30
- L**
- lamp test 16
- LCD display 12, 16
- LCD-80F annunciator 13, 23
- LDM Series annunciator 23
- LDM-32 Graphic Annunciator 13
- LED
 - AC Power 106
 - Alarm Silenced 106
 - Battery 106
 - Disabled 106
 - Fire Alarm 106
 - Ground 106
 - Maintenance 106
 - see also Indicators 16
 - Supervisory 106
 - Trouble 106
- LED annunciator 22
- Local Energy Municipal Box Service 31
- Loop Setup 74
- M**
- M300 Monitor Module 20
- M301 Miniature Monitor Module 20
- M302 2-wire Monitor Module 20
- main circuit, mounting 24
- Maintenance Alert 12, 112
- maintenance alert 125
 - levels 125
- Maintenance Program Level 2 40, 97
- Manual programming 39
- Manual Pull Station 19
- Master Program Level 1 40, 42
- MDF-300 monitor module 19
- Medical Alert 111
- MMF-300 monitor module 19
- MMF-301 monitor module (miniature) 19
- MMF-302 monitor module 19
- Mode key 41
- Module 13
 - add 53
 - addressing 19
 - delete 54
 - edit monitor 55
 - enable/disable 57
 - see also addressable modules 19
- Module Programming 53
- Monitor module
 - adjective 60
 - enable/disable 57
 - noun 61
 - noun/adjective 59
 - type 57
 - type action 58
 - Type list 57
 - type selection 58
- monitor module 19
- Mounting
 - cabinet 24
 - main circuit board 24
- municipal box transmitter
 - see also 4XTMF module 31
- N**
- NAC 14, 17, 81, 111
 - Auto Silence 84
 - coded 113
 - coding 84
 - current 14
 - End-of-Line Resistor 14
 - power 12

Index

- see also Notification Appliance
 - Circuit 12, 28
 - silence inhibit 85
 - silenceable 83
 - synchronized 113
 - type codes 83
 - voltage drop 14
 - voltage, operating 14
 - wiring diagram 28
 - wiring Style 28
- NAC enable/disable 82
- NAC options 75
- NAC type 83
- N-ELR Mounting Plate 20
- NFPA Battery Requirements 130
- nonpower-limited
 - relay connections 28
- Nonresettable Power 17, 27
 - current 14, 27
- nonsilenceable waterflow 73
- Normal 107
- normal display 39
- Notification Appliance Circuit 14, 81
 - see also NAC 12, 28
- Noun
 - monitor module 61
 - multiple entries 52
- Noun list 51
- Noun/Adjective 49, 51
 - control module 66
 - monitor module 59
- O**
- Off-line Programming 39
- Operating Instructions 105
- Operation
 - alarm 109
 - disable/enable 112
 - hazard condition 111
 - medical alert 111
 - NAC 111
 - normal 107
 - process monitor 111
 - programmed zone 112
 - supervisory 110
 - trouble 107
 - waterflow 112
- Option Modules 20, 30, 91
 - annunciators/UDACT 91
 - Printer/PC 92
- Options 12
- Output Circuits 17
- P**
- PAS 48, 71, 114
 - see also Positive Alarm Sequence 13, 47
 - selection 59
- PAS BYPASS 114
- PAS timer 79
- Password 13, 40
 - change 93
 - Maintenance Level 2 41, 97
- password
 - Master Level 1 41
- PC (personal computer)
 - configuration 34
 - connection 34
 - ground fault 34
- Piezo
 - see also sounder 16
- PK-9600 Programming Utility 21
- Point Program 43
- Positive Alarm Sequence 47, 114
 - see also PAS 13
- power
 - NAC 12
 - nonresettable 14
 - resettable smoke 14
 - system 12
- power supply calculations 127
- power-limited
 - relay connections 28
- Power-up
 - first time 40
- Pre-signal 13, 48, 71
 - function 113
 - selection 59
- Pre-signal Delay timer 80
- Pre-signal timer 79
- primary power
 - see also AC Power 27
- printer
 - baud rate 92
 - configuration 34
 - connection 34
 - ground fault 34
 - setup 34
- Printer/PC interface 12
- Process Monitor 111
- Program
 - check 95
 - check correlations 95
 - clear 94
- Program Check
 - Maintenance Level 100
- program keys
 - see also Key Panel 16
- Programming 38, 39
 - autoprogramming 39
 - exiting 39
 - factory default 139
 - Level 1 40
 - Level 2 40
 - manual 39
 - Master Level 1 42
 - modules 53
 - off-line computer 39
 - via computer keyboard 38
 - via panel keypad 38
- Programming Levels 40
- Programming Screens 40
- Programming Sheet 133, 134, 135, 136, 138
- Programming Utility
 - see also PK-9600 21
- PRT/PK-CABLE
 - for PC/Printer connection 34
- R**
- RA400Z
 - see also detector annunciator 19
- Read Status 39, 117
 - annunciators 123
 - exiting 39
 - history 122
 - NAC 121
 - power 120
 - Print 124
 - printer/PC 123
 - program check 122
 - relay 122
 - system point 118
 - Time-Date 126
 - timers 121
 - trouble reminder 120
 - zones 119
- Real-Time Clock 112
- Recall/Increment Function 52, 62, 69
- Relay 14, 17, 28, 86
 - connections 28
 - contact rating 14, 17, 28
 - fixed 28
 - Form-C 14, 86
 - programmable 12, 17, 28
 - programming 86
 - selections 86
 - trouble 12, 17, 28
- Relay Control Module
 - see also ACM-8RF 35
- relay module 19
- Relay options 75
- Remote Station Service 31
- remote switch functions 13
- Reset 16, 105
- Resettable Power 17, 27
 - current 27
 - see also Smoke Detector Power 14
- S**
- SD300 Photoelectric Detector 20
- SD300T Photoelectric Detector 20

Index

- SD350 18
- SD350T 18
- Secondary Power Requirements 130
- sensitivity 112, 125
 - see also smoke detector sensitivity 112
- Signal rate 13
- Signaling Line Circuit 14
- Silence Inhibit 13, 85, 115
- Silenceable
 - control module 65
 - NAC 83
- silenceable circuits
 - synchronized signals 83
- silenceable waterflow 73
- SLC 13, 14, 17
 - current 14
 - reference manual 14
 - resistance 14
 - see also Signaling Line Circuit 12
 - Style 17
 - voltage 14
 - wiring length 14
- SLC Loop Protocol 74
- SLC loop selection 43
- SLC Style 74
- SLC-2 33
 - installation 33
 - wiring 33
- SLC-2 Expander Module 20
- smoke detector
 - chamber reading 124
 - data 112, 124
 - sensitivity 112
- Smoke Detector Power
 - current 14
- smoke detector sensitivity 12
- Software Zones 12, 131
- sounder 16
- Specifications 14
- strobe synchronization 13
- Style 12
- Style B 19
- Style D 19
- Style Y 19, 28
- Style Z 19, 28
- subscreen 40
- Supervisory 110
- sync
 - programming 82
 - see also synchronization 85
- synchronization 113, 121
 - by manufacturer 85
 - programming 85
 - see also strobe synchronization 13
- synchronized 113
- Synchronized Signals 113
- synchronized signals
 - and silenceable circuits 83
- System
 - Maintenance Level 101
- System Point 118
- system power 12
- System Setup 75
- T**
- Time and Date
 - Maintenance Level 102
- Time setting 77
- Time-Date setting 75, 77
- Timers 75
- Transmitter Module 31
 - see also 4XTMF module 20
- Trouble 107
- trouble display 108
- trouble relay 12
- Trouble Reminder 75, 115, 120
- trouble responses 108
- Type
 - control module 65
 - detector 47
 - monitor module 57
 - NAC 83
- type code
 - control module 65
 - supervision 112
- type-code
 - verification 12
- U**
- UDACT-F
 - mounting to BRKT-9600 36
 - programming 35
 - see also Digital Alarm Communicator/Transmitter 35
- UL power-limited wiring requirements 29
 - see also power-limited and non-power-limited 28
- Universal Bracket
 - see also BRKT-9600 35
- V**
- Verification
 - detector 47
- Verify Loops 88
- View Events 89
- voltage
 - measurements 120
 - ranges 120
- W**
- Walktest 13, 47, 66, 90
 - audible 90
 - Maintenance Level 101
 - operation 116
 - selection 59
 - silent 90
- waterflow
 - nonsilenceable 73
 - silenceable 73
- Waterflow Delay timer 79, 80
- Waterflow Retard Timer 115
- Wire Requirements 140
- wiring
 - AC Power 27
 - earth ground 27
 - SLC-2 33
 - wiring control modules
 - see also Style Y or Style Z 19
 - wiring modules
 - see also Style B or Style D 19
 - wiring Style 12
- Z**
- Z00 49, 59
- Z97
 - PAS zone 48
- Z98 48
- Zone 97 71
- Zone 98 71
- Zone Assignment 49, 59
 - control module 66
- Zone assignment 85
- Zone Setup 70
 - Maintenance Level 103
- zone type 73
 - list 73
- Zone Z97 48
- Zone Z98
 - pre-signal zone 48
- Zones 119, 131
 - see also software zones 12
- Zones Disabled 72
- Zones Enabled 72
- Zones Installed 72
- zones per device 49

Notes

Notes

Limited Warranty

The manufacturer warrants its products to be free from defects in materials and workmanship for eighteen (18) months from the date of manufacture, under normal use and service. Products are date-stamped at time of manufacture. The sole and exclusive obligation of the manufacturer is to repair or replace, at its option, free of charge for parts and labor, any part which is defective in materials or workmanship under normal use and service. For products not under the manufacturer's date-stamp control, the warranty is eighteen (18) months from date of original purchase by the manufacturer's distributor unless the installation instructions or catalog sets forth a shorter period, in which case the shorter period shall apply. This warranty is void if the product is altered, repaired, or serviced by anyone other than the manufacturer or its authorized distributors, or if there is a failure to maintain the products and systems in which they operate in a proper and workable manner. In case of defect, secure a Return Material Authorization form from our customer service department. Return product, transportation prepaid, to the manufacturer.

This writing constitutes the only warranty made by this manufacturer with respect to its products. The manufacturer does not represent that its products will prevent any loss by fire or otherwise, or that its products will in all cases provide the protection for which they are installed or intended. Buyer acknowledges that the manufacturer is not an insurer and assumes no risk for loss or damages or the cost of any inconvenience, transportation, damage, misuse, abuse, accident, or similar incident.

THE MANUFACTURER GIVES NO WARRANTY, EXPRESSED OR IMPLIED, OF MERCHANTABILITY, FITNESS FOR ANY PARTICULAR PURPOSE, OR OTHERWISE WHICH EXTEND BEYOND THE DESCRIPTION ON THE FACE HEREOF. UNDER NO CIRCUMSTANCES SHALL THE MANUFACTURER BE LIABLE FOR ANY LOSS OF OR DAMAGE TO PROPERTY, DIRECT, INCIDENTAL, OR CONSEQUENTIAL, ARISING OUT OF THE USE OF, OR INABILITY TO USE THE MANUFACTURER'S PRODUCTS. FURTHERMORE, THE MANUFACTURER SHALL NOT BE LIABLE FOR ANY PERSONAL INJURY OR DEATH WHICH MAY ARISE IN THE COURSE OF, OR AS A RESULT OF, PERSONAL, COMMERCIAL, OR INDUSTRIAL USE OF ITS PRODUCTS.

This warranty replaces all previous warranties and is the only warranty made by the manufacturer. No increase or alteration, written or verbal, of the obligation of this warranty is authorized.



World Headquarters

One Fire-Lite Place, Northford, CT 06472-1653 USA

203-484-7161 • Fax 203-484-7118

www.firelite.com

ISO 9001
CERTIFIED
ENGINEERING & MANUFACTURING