

7100 Series Control/Communicator

Advanced User's Guide

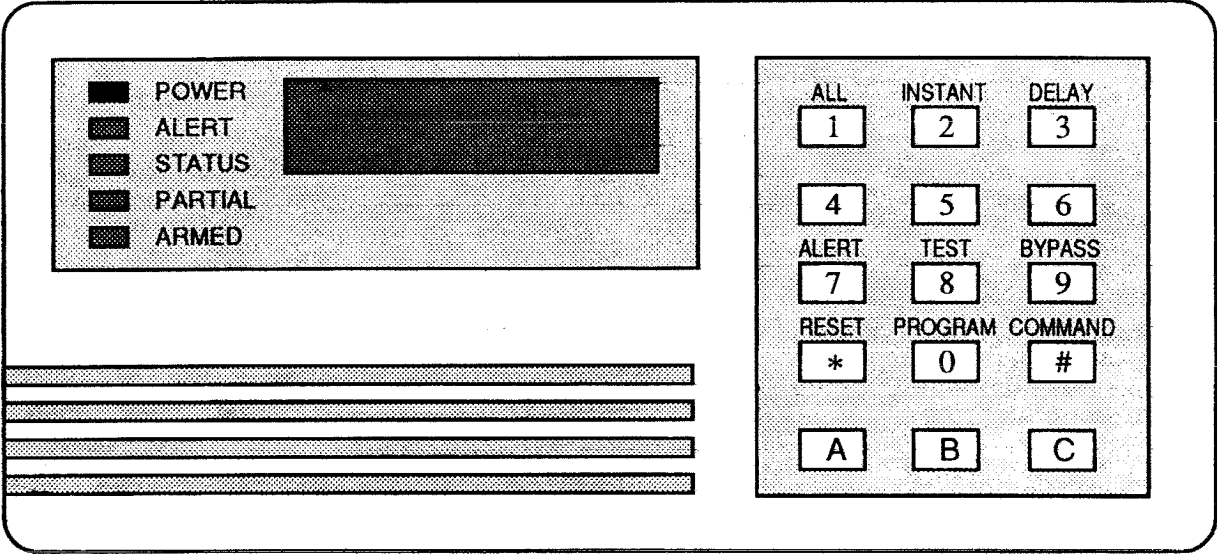

TABLE OF CONTENTS

SECTION	CONTENTS	PAGE	SECTION	CONTENTS	PAGE
A.	PRODUCT OVERVIEW	1	H.	USER CODE and PROGRAM CHANGES	
B.	REFERENCE GUIDE			General Code Information	13
	Emergency Telephone Numbers	1		Basic Format for User Code Changes	13
	Audible Alarm Sounds	1		Changing the Master Code	14
	Protected Area Information	1		Programming a Temporary User Code	14
C.	THE CONTROL STATION KEYPAD			Modifying a User Code	14
	General	2		Cancelling a User Code	14
	Keypad Information	2		General Program Information	15
	Sounder Operation	2		Basic Format for Program Changes	15
	Indicator Light Operation	3		Changing Current Time Example	15
D.	ARMING (turning on) YOUR SYSTEM			Read Back Display	16
	Default (Normal) Arming	4		Cancel the Program Mode	16
	Perimeter/Instant Arming (occupied)	4	I.	PROGRAM DETAIL GUIDE	
	Perimeter/Delay Arming (occupied)	5		I.1 Current Time	17
	Custom Arming	5		I.2 Current Day of Week	18
	Force Arming	6		I.3 Opening and Closing Window Length	19
	Auto Arming	6		I.4 Automatic Arming Time	20
				I.5 Opening and Closing Start Times	21
E.	DISARMING (turning off) YOUR SYSTEM		J.	HISTORY DISPLAY INFORMATION	
	Default (Normal)	7		General	22
	Duress (Ambush)	7		Activity Display Information	
F.	IN THE EVENT OF AN ALARM			Alarm	22
	A Cautionary Note	8		Close (Arm)	22
	Types of Alarms	8		Emergency - Keypad	22
	To Silence an Alarm	8		Fire - Keypad	23
G.	COMMANDS/OTHER SYSTEM FEATURES			Fire - Zone Alarm	23
	General Recap	9		Medical - Keypad	23
	Access Control	9		Open (Disarm)	23
	Alarm History Display	9		Program Mode - Local and Remote	24
	Alert Mode	9		Bypass	24
	Battery Test	10		Unbypass	24
	Communicator Test	10		Characters and Other Displays Used	25
	Emergency Keypad Alarms	10	K.	GLOSSARY	
	Error Display	11		AccessCode/Access Control	26
	Fire Reset	11		Automatic Arming	26
	Indicator Light and Display Test	11		Communicator Test	26
	Remote Program Dialout	11		Day Monitor	26
	Remote Programming Enable	11		Dial Tone Test / Ringback	27
	Sounder Test	12		Fire Alarm	27
	Special Area Protection	12		Fire Trouble	27
	Area Bypass	12		Force Arm	27
	Area Test	12		Invisible Area	27
				Special Area Protection	28
				Area Status Display	28
			L.	PROGRAM WORKSHEET	29
			M.	INDEX	30

A

PRODUCT OVERVIEW

The 7100 is a combination intrusion and fire alarm control unit with keypad control and alarm communication capabilities.

Your system consists of the 7100, one or more keypad control stations, and up to fifteen supervised areas of protection, one of which may be a dedicated fire protection area.

Each area can be thought of as a mini-system set up to protect a part of your building. A area can be a single door or window, or can include an entire area or floor of your building. The concept of areas, as it will be found, will allow you to be able to selectively apply protection to either a part of your building, or the entire building at once.

Connected to the areas are detection devices which may include door or window contacts; motion sensors; pressure sensitive mats; glass breakage sensors; emergency (panic, holdup or ambush) buttons; and smoke and/or heat sensors.

When a detector senses an alarm condition, the area it is assigned to will report that condition to the control through the wiring used to construct the area. If the area has not been bypassed (electronically disconnected from the control), and if the system is "armed", the control will then activate alarm signalling devices. These

devices may be part of a "local alarm system" consisting of sirens, bells and/or lights on your building, or may communicate the alarm to a remote location using an automatic telephone dialer or long-range radio.

Your system is armed (turned on) or disarmed (turned off) by entering an appropriate user's code into a keypad control station. The system is armed when the premises or part of the premises is to be protected, and disarmed when protection is not necessary. When the system is disarmed, the detectors will continue to operate, but the control will not permit the alarm signalling devices to activate. *The only exception to this are alarms from fire protection or 24 Hour areas which will cause alarm signalling devices to activate even if the control is disarmed. This is for your safety.*

The 7100 is a state-of-the-art control with advanced features that have been custom programmed by your installing company to suit your specific needs. Because of this, some of the features listed in this manual may not be available to you. *Please read this manual carefully so that you may become familiar with your system, then keep the manual in a safe place in case it is needed for future reference.*

B

REFERENCE GUIDE

Emergency Telephone Numbers

Fire _____
Police _____
Ambulance _____
Doctor _____
Monitoring Service Phone No. _____
Monitoring Service ID # or Code _____

Audible Alarm Signalling Device Sounds

Zone Alarms:

Intrusion () Pulse () Continuous
Fire () Pulse () Continuous

Keypad
Emergency () Pulse () Continuous () Silent

Zone No.	Protected Area (zone)
1	_____
2	_____
3	_____
4	_____
5	_____
6	_____
7	_____
8	_____
9	_____
10	_____
11	_____
12	_____
13	_____
14	_____

THE CONTROL STATION

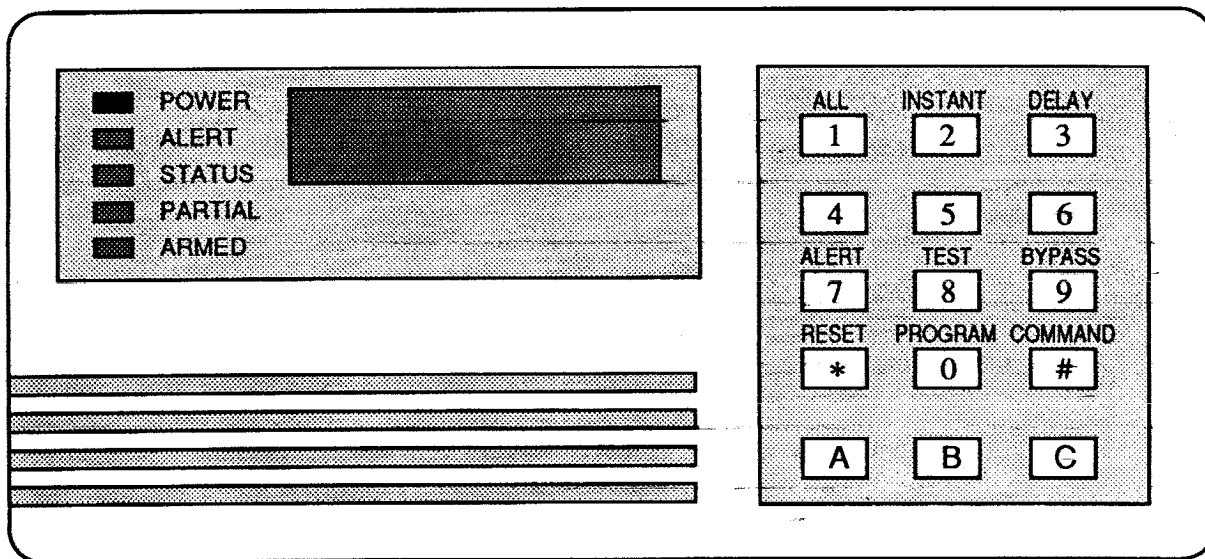

Shown is the 7135 keypad

GENERAL

System operation is accomplished using a Control Station keypad. Viewable components of the Control Station include the five indicator lights (Power, Status, Partial, Armed and Alert), a display window and telephone style keypad.

KEYPAD INFORMATION

The keypad consists of 15 keys which are numbered and arranged in a standard telephone touch-pad configuration.

In addition to the standard numbers and symbols, many keys are also defined with a word that will help you to remember some of the command sequences needed to operate your system.

- All = Arm all areas not bypassed
- Instant = Arm only Perimeter areas, making them Instant alarms
- Delay = Arm only Perimeter areas, allow delayed entry
- Alert = Perimeter Alert tone enable
- Test = Test selected system functions
- Bypass = Bypass violated areas
- Reset = Cancel present keypad sequence entries
- Program = Enter the Program mode
- Command = Pressed before the above "Commands"
- A = _____
- B = _____
- C = _____

In this manual, information within brackets [] indicates a keypad key that must be depressed. [Command/#], as an example, is the lower, right hand key of the keypad.

A train of brackets [] [] [] indicates a sequence of keys that must be depressed. [Command/#] [Test/8] [Program/0] is an example of a command sequence that will tell the control to test its internal standby battery.

SOUNDER OPERATION

The built-in sounder will emit a short beep each time a key is pressed. In addition, the sounder is used as an interior warning and audible alarm device, and will produce different beep sequences depending upon the event it is signalling.

Your building may also be equipped with any combination of bells, sirens or lights to indicate an alarm, as well as exterior devices to alert your neighbors of an emergency, and guide emergency personnel to your location. These will be referred to throughout this manual as *Alarm Sounding Devices*.

INDICATOR LIGHT OPERATION

The keypad contains five colored indicator lights used to give a visual indication of the state or condition of your system. While they usually operate independent of each other, the activity of certain combinations of lights acting together are used to indicate different modes of control operation.

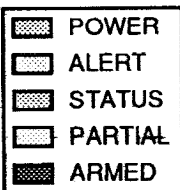

Power (green light):

OFF – The control has lost all power (no AC or battery).

FLASHING – Control problems exist. (See *Error Display*, page 11.)

ON – The control is running on AC power without problems. (Normal operation.)

Alert (yellow light):

OFF – The control is **not** in the instant mode (when armed), or in the Alert mode (when disarmed).

FLASHING - Special Area protection is activated.

ON – The control *is* in the instant mode (when armed), or in the Alert mode (when disarmed).

Status (green light):

OFF – One or more areas are violated (in alarm), or the control is armed.

FLASHING – The exit delay period is in progress.

ON – All areas are secure (not in alarm) or bypassed.

Partial (yellow light):

OFF – The control has *no* bypassed areas.

FLASHING – The control has at least one bypassed area.

ON – *All* interior areas only are bypassed.

Armed (red light):

OFF – The control is disarmed.

FLASHING – The control is still armed, and an alarm has occurred.

ON – The control is armed, and no alarms have occurred.

The green *Status*, yellow *Partial*, and red *Armed* lights **Flashing together** indicate the control is in the "Area Test" Mode.

D

ARMING YOUR SYSTEM with no one remaining on premise

If the green *Power* light is flashing call your alarm installing company listed on page 1 or see "ERROR DISPLAY" on page 11.

To arm the system from a Control Station, the green *Status* light must be ON indicating all areas are secured and/or bypassed. If the green *Status* light is not on, see AREA BYPASS on page 12 or FORCE ARMING on page 6.

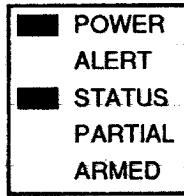

- () This system requires a User Code be entered before entering an Arming Command.
- () Entering a User Code is not required before entering an Arming Command.

Enter the command sequence at the right if you are leaving the premises and no one will remain. If someone will remain on the premises see Perimeter/Instant Arming page 4, Perimeter/Delay Arming page 5 or Custom Arming page 5.

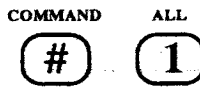

After entering the proper code sequence, the red *Armed* light will turn ON indicating the control is armed.

The green *Status* light will pulse on and off during the exit delay interval, then turn OFF when the delay expires. You should leave the premises *before* the delay period ends but only after the following sound is heard.

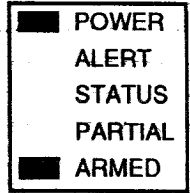

- () Bell for 2 seconds.
- () Siren for 2 seconds.
- () Control Station sounds a single beep for 1 second.
- () _____

This sound may be delayed while the control verifies the phone line connection. If the above sound is not heard or the control station sounds a three beep tone and displays "Err" disarm the control and call your Monitoring Service listed on page 1 of this manual.

Note: The control battery is automatically tested every 24 hours, however it is possible to arm the control in a residential application with a depleted battery. See BATTERY TEST page 10.

ARMING YOUR SYSTEM with someone remaining on premise, no entry

If the green *Power* light is flashing call your alarm installing company listed on page 1 or see "ERROR DISPLAY" on page 11.

To arm the system from a Control Station, the green *Status* light must be ON indicating all areas are secured and/or bypassed. If the green *Status* light is not on, see AREA BYPASS on page 12 or FORCE ARMING on page 6.

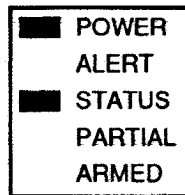

- () This system requires a User Code be entered before entering an Arming Command.
- () Entering a User Code is not required before entering an Arming Command.

Enter the command sequence at the right if someone will remain on the premises and you want to prevent any entry during the armed period.



If this is not what you desire see Arm All page 4, Perimeter/Delay Arming page 5 or Custom Arming page 5.

After entering the proper code sequence, the red *Armed* light will turn ON indicating the control is armed.

The green *Status* light will pulse on and off during the exit delay interval, then turn OFF when the delay expires. You should leave the premises *before* the delay period ends if you desire to leave. Remember that if you re-enter after arming the control with this command an alarm will result.

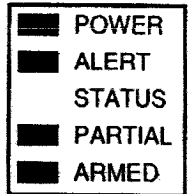

The control will acknowledge that all protection is in place by sounding a single Control Station beep.

Arming the system with this command will cause the yellow *Partial* light to turn ON constant. The control will arm only Perimeter protection areas (including entry/exit). Areas programmed as Interior protection will not be armed (that is, interior protection remains off, and movement in the premise is allowed). The yellow *Alert* light will also light indicating instant alarm.

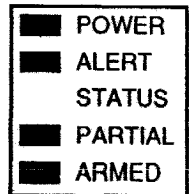

ARMING YOUR SYSTEM with someone remaining on premise, allow entry

If the green *Power* light is flashing, call your alarm installing company listed on page 1 or see "ERROR DISPLAY" on page 11.

To arm the system from a Control Station, the green *Status* light must be ON indicating all areas are secured and/or bypassed. If the green *Status* light is not on, see AREA BYPASS on page 12 or FORCE ARMING on page 6.

■	POWER
■	ALERT
■	STATUS
■	PARTIAL
■	ARMED

() This system requires a User Code be entered before entering an Arming Command.

() Entering a User Code is **not** required before entering an Arming Command.

Enter the command sequence at the right if someone will remain on the premises and you want to allow entry during the armed period.

COMMAND	DELAY
#	3

If this is not what you desire, see Arm All on page 4, Perimeter/Instant Arming on page 4, or Custom Arming on page 5.

After entering the proper code sequence, the red *Armed* light will turn ON indicating the control is armed. The green *Status* light will pulse on and off during the exit delay interval, then turn OFF when the delay expires. You should leave the premises **before** the delay period ends if you desire to leave.

■	POWER
■	ALERT
■	STATUS
■	PARTIAL
■	ARMED

The control will acknowledge that all protection is in place by sounding a Control Station beep.

Arming the system with this command will cause the yellow *Partial* light to turn ON constant. The control will arm only Perimeter protection areas (including entry/exit). Areas programmed as Interior protection will **not** be armed (that is, interior protection remains off, and movement in the premise is allowed).

■	POWER
■	ALERT
■	STATUS
■	PARTIAL
■	ARMED

CUSTOM ARMING YOUR SYSTEM

If the green *Power* light is flashing call your alarm installing company listed on page 1 or see "ERROR DISPLAY" on page 11.

To arm the system from a Control Station, the green *Status* light must be ON indicating all areas are secured and/or bypassed. If the green *Status* light is not on, see AREA BYPASS on page 12 or FORCE ARMING on page 6.

■	POWER
■	ALERT
■	STATUS
■	PARTIAL
■	ARMED

() This system requires a User Code be entered before entering an Arming Command.

() Entering a User Code is **not** required before entering an Arming Command.

Enter one of the command sequences at the right to arm in one of the custom modes.

COMMAND	
#	4

COMMAND	
#	5

COMMAND	
#	6

If this is not what you desire, see Arm All on page 4, Perimeter/Instant Arming on page 4, or Perimeter/Delay Arming on page 5.

After entering the proper code sequence, the red *Armed* light will turn ON indicating the control is armed. The green *Status* light will pulse on and off during the exit delay interval, then turn OFF when the delay expires. You should leave the premises **before** the delay period ends if you desire to leave.

■	POWER
■	ALERT
■	STATUS
■	PARTIAL
■	ARMED

The control will acknowledge that all protection is in place by sounding a Control Station beep.

This feature must be disabled on UL certificated installations.

Use [Command/#] [4] for _____

Use [Command/#] [5] for _____

Use [Command/#] [6] for _____

FORCE ARMING YOUR SYSTEM with one or more areas in alarm

When one or more areas are in alarm (green *Status* light is off), the control may still be forced to arm the system by bypassing the violated areas.



To Force arm the control, first enter any of the arming command sequences on pages 4 or 5, at which time the sounder will start sounding a 5 second long beep. Then (during the beep), press [Bypass/9]. All violated areas will be bypassed, the sounder will cease, and the control will arm.

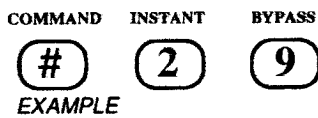

If a three beep tone is heard and an Err message displays instead of the 5 second long beep then the control may not be forced armed. Any violated areas will have to be cleared of alarms prior to attempting to arm the control. (See *Area Bypass*, Page 12, for individual area bypassing.)

This feature must be disabled on UL certificated installations.

Warning:

The user is cautioned that any area bypassing or force arming removes some of your protection. Therefore an intrusion may not be detected or that detection may be delayed. Use area bypassing and force arming with caution and always attempt to correct any area problems (open doors and windows etc.) before using these features. If the problem can't be corrected contact your alarm service company.

AUTOMATIC ARMING

Your system may be automatically armed at a specific time each day. See section 1.4 "Automatic Arming Time".

- () This system will Automatically Arm at _____.
- () This system does not have Automatic Arming.

DISARMING YOUR SYSTEM

CAUTION: IF THE RED ARMED LIGHT IS FLASHING, AND/OR THE CONTROL STATION IS SOUNDING A PULSING TONE, THE CONTROL IS SIGNALLING THAT AN ALARM HAS OCCURRED. IF THE ALARM HAS NOT BEEN PREVIOUSLY INVESTIGATED, DO NOT ENTER THE BUILDING UNLESS IN THE COMPANY OF THE APPROPRIATE EMERGENCY SERVICES' PERSONNEL.

DEFAULT (NORMAL) DISARMING

 To disarm the control first enter a User Code having disarm privileges, then press [Command/#]. This sequence must be completed before the Entry Delay period ends. If successfully entered, the red *Armed* light will turn OFF.

This system is programmed for _____ seconds of Entry Delay before sounding the alarm if the Entry/Exit area is the first one violated when entering the building.

DURESS (AMBUSH) DISARMING

 Entering a code one digit higher than your User Code is a Duress code. A Duress code is used when someone demands, by threatening your life or well-being, that the system be disarmed. When used, the code will both disarm the system and report a silent duress alarm if connected to a monitoring service. Extreme care should be used when entering your users code to turn off the system, so the duress code is not inadvertently entered.

Example; if your User Code = 222, then 223 is a Duress code. The control will give no indication that the Duress code was used, and will outwardly respond the same as if the Default Disarming code was used. **NOTE: Be careful of User Codes that end in a 9.** Example; if your User Code is 229, then the Duress Code is 220, **and not 230.**

- () This system has the Duress Alarm feature.
- () This system **does not** have the Duress Alarm feature.

IN THE EVENT OF AN ALARM



A CAUTIONARY NOTE

How you respond in the event of an alarm will depend, for the most part, on the type of alarm and the time the alarm occurs. You should seek the advice of your installing company in developing your response plan during the installation phase of your system and not later, after an alarm has occurred.

Above all else, common sense should prevail. If there is any threat or hint of danger to yourself or others on the premises, such as in the event of a fire alarm, everyone should be instructed to leave the premises immediately. Do not enter the premises unless in company with the appropriate Emergency Services' personnel, or after they have given the OK to do so.

TYPES OF ALARMS

Intrusion (Burglary) - In order for this type of alarm to occur, the control must be armed. An intrusion alarm results when any armed intrusion detection area has been violated, and will result in the activation of alarm sounding devices.

24 Hour - Similar to an Intrusion alarm except areas programmed for 24 Hour will cause an alarm *even if the system is disarmed*. (24 Hour areas are usually assigned to Emergency/Panic buttons and/or high-security entrances or areas that are **not normally** used even during non-protected hours. Example: Tobacco and drug rooms.)

Emergency Keys - Entering a Special Key command sequence programmed for fire [A], emergency (police) [B] or silent [C] response will produce an emergency key-input alarm if so programmed. The control may be armed or disarmed. These alarms will result in the activation of alarm sounding devices.

Fire - Usually programmed so that audible alarm sounds are different from intrusion alarm sounds. These alarms are generated from the fire zone, or the use of one of the Special Key commands if programmed for fire. The control may be armed or disarmed. If an alarm other than a fire alarm is sounding, the fire alarm will override the other alarm.

TO SILENCE AN ALARM

Your system should be programmed to turn off activated alarm sounding devices after a specific period of time.



However, if you wish to manually turn off these devices before the programmed time period ends, enter any User Code that has Disarm privileges. This will also disarm the control as well as silence the alarm sounding devices.

In the event of a *Fire* alarm, entering a User Code and [Command/#] will silence the sounders and disarm the control (if armed), but will *not* reset the smoke detectors. **AFTER** the detectors causing the alarm have been identified, use the Fire Reset command sequence [Command/#] [Test/8] [Program/0] to then reset the detectors. See page 11.

The automatic cut-off times for each alarm:

Intrusion (includes 24 Hour) _____ minutes.

Fire Alarm _____ minutes.

Keypad Emergency _____ minutes.

G

COMMANDS FOR OTHER SYSTEM FEATURES

GENERAL RECAP

System features are activated by entering Program Commands into any Control Station keypad.

Each press of a key will sound a short beep. If an alarm or entry prealert is currently sounding, a short quiet period will indicate the key press was accepted.

Each time a keypad command turns a function *on*, the sounder will give a long beep. When a function is turned *off*, a short beep is sounded.

Keypad entry errors will result in three (3) short beeps, and the message **Err** will show in the display. If an alarm or entry prealert is currently sounding, three short quiet periods will indicate the entry error.

Pressing a key not recognized as part of the current input sequence will cancel the sequence, and the three beep error tone will sound.

For all key input sequences, the [Reset/*] key is used to reset the keypad to the start of a new sequence. When the [Reset/*] key is pressed, the three beep error tone will sound and the keypad will be immediately ready for a new sequence.



ACCESS CONTROL



Your system may feature electric locking control of a door: usually the main entrance door or a door into a restricted area. If so, then one or more User Codes may be programmed as Access Control Codes allowing the door to be electrically unlocked by entering the code at any installed Control Station

To operate the locking mechanism, first enter the access control code, then [Command/#]. The door will then remain unlocked for the programmed time period.

() This system does **not** feature Access Control. *This feature must be disabled on UL certified installations.*

() This system features Access Control of the _____

ALARM HISTORY DISPLAY

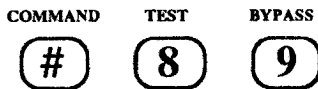

Various commands and control unit responses are recorded in the control unit's memory for later playback.

This activity history playback should be activated only when the control is *disarmed*. When activated, the display can be commanded by depressing the [Command/#] key to show control activity events in reverse chronological order (starts with most recent). These events are kept in a "history buffer", which will maintain a total of 96 events. As a new event is entered, it becomes the most recent, and causes the oldest event to be erased.

The history display may be cancelled by pressing the [Reset/*] key, or if the [Command/#] key is not depressed for 40 seconds. (See Section J, *History Display Information*, for details.)

ALERT MODE

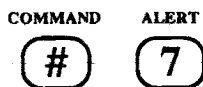

Activate the Alert mode only when the control is disarmed. This mode causes the control station sounders to beep each time a Perimeter or Entry/Exit area is violated while the control is disarmed. The Alert mode will remain active until the next time the Alert command is entered.

When the control is disarmed, the Alert mode will light the yellow *Alert* light on all control stations. Arming and disarming the control does not affect the Alert mode, although the *Alert* light will turn off during armed periods.

BATTERY TEST

COMMAND TEST PROGRAM
8 0

In the event there is a power failure, your control should have a built-in rechargeable standby battery that will continue to power the control for many hours. The control will then automatically recharge the battery when building power is restored.

In addition to an automatic battery test performed every 24 hours, the battery may also be tested with the above key-command. However, as the Battery test uses the same key-command sequence as the Fire reset, ***the user is cautioned to understand that testing the battery will also reset any fire/heat/smoke detectors that may be in an alarm condition.***

The green *Power* light will pulse on and off during the key-command battery test. If the battery tests OK, the *Power* light will return to normal after 10 seconds. If the test fails, the light will continue to pulse. (See *Error Display*, page 11 for a display of the *Lo b* message, and a procedure to return the *Power* light to constant on.)

COMMUNICATOR TEST

COMMAND TEST INSTANT
8 2

If your control contains a digital communicator for alarm reporting, it may be manually tested by entering [Command/#] [Test/8] [Instant/2]. The green *Power* light will pulse on and off during the communicator test, and a "Test" report will be sent to the monitoring service.

A long beep will initially sound to acknowledge the start of the test. If the test is successful, the sounder will again issue one long beep, and the *Power* light will return to normal. If the test fails, the light will continue to pulse. The keypad sounder will turn ON constant until the [Reset/*] key is pressed. (See *Error Display*, page 11 for a display of the *C Er* message.)

() This system has the communicator test feature.

() This system does **not** have the communicator test.

EMERGENCY KEYPAD ALARMS

The Special Alarm Keys [A], [B] and [C] may generate Fire, Emergency and Silent alarms if programmed by the installer. The functions if any programmed for these keys are listed on page 2.

When using the Special Alarm Keys, they must be held for two seconds to generate an alarm.

Use the Disarming command sequence to cancel these emergency alarms (Page 7).

If the [C] key is programmed for an alarm, the sounder will beep once every five seconds until a User Code with disarm privileges is entered.

ERROR DISPLAY

COMMAND TEST ALERT
(#) (8) (7)

Control problems are indicated and displayed only in the disarmed mode. A pulsing green *Power* light indicates that one or more control problems exist.

To display the problems, enter [Command/#] [Test/8] [Alert/7], and observe the display. The error codes will be displayed one at a time and will scan through twice.

- C Er** = Communicator failed to communicate. (Contact your installing company for help.)
- Lo b** = Battery problem. Missing or low voltage. (If system has just been through a power failure, wait at least two hours for the battery to begin recharging to full potential, then enter the **BATTERY TEST** command. Contact your installing company if code **Lo b** persists.)
- AC F** = AC power failure. *If arming press [Bypass/9] to arm without AC.*
- EE P** = Error in program memory. (Contact your installing company.)

COMMAND TEST ALERT RESET
(#) (8) (7) (*)

ERROR RESET - To reset the pulsing green *Power* light, enter the key sequence shown to the left only after displaying the errors above.

FIRE RESET

COMMAND TEST PROGRAM
(#) (8) (0)

This command will reset any fire / heat / smoke detectors after a fire alarm has occurred. Enter the Fire Reset command sequence only in the disarmed mode. This command initiates two functions: resets fire detectors, and performs a battery test. This command sequence will also cancel the *Fire Alarm* display on the Control Stations. **Before this command is used determine which smoke detector had alarmed.**

NOTE: *The fire alarm must be silenced using a User Code with disarm privileges before a fire reset can be performed.*

INDICATOR LIGHT/DISPLAY TEST

COMMAND TEST
(#) (8) (4)

To test the Control Station indicator lights to see if they are in working condition, enter the test command sequence only in the disarmed mode. When this test is run, all control station lights and display segments will turn *ON* constant for five (5) seconds. At the end of this time, the lights and display will return to their previous condition and three beeps will sound.

REMOTE PROGRAM DIALOUT

COMMAND TEST DELAY
(#) (8) (3)

Your monitoring service may have provisions to program or change some of your system commands or features from their station via telephone. If so, your 7100 control may be wired to a telephone line permitting the control to call the remote station, or vice-versa. The telephone number should have been programmed into the control by the installing company.

Use the *Remote Program Dialout* command sequence to **call the remote station**. Dialout and communications between the control and the remote station is automatic after the command sequence is entered. Disarmed mode, only. (See also *Remote Programming Enable*, below.)

REMOTE PROGRAMMING ENABLE

COMMAND TEST
(#) (8) (6)

Use the *Remote Programming Enable* command to permit the remote station to **call your control**. This command is the electronic "key" that will allow them access to your system. As a further level of security, the control will not accept remote programming unless the proper programming code is then given by the remote programmer. Enter the Remote Program Enable command sequence only in the disarmed mode. Both this command and the Remote Program Dialout command will cause the phone line to be seized, and allow the control to communicate with the remote station.

SOUNDER TEST

COMMAND TEST

(#) (8) (5)

To test (audible and lighting) alarm sounding devices, enter the Sounder Test command sequence only in the disarmed mode. This will cause the Control Station sounders and all alarm sounding devices to operate for two (2) seconds. At the end of this time, all such devices will return to their previous condition. If the alarm sounding devices do not sound or the green power indicator light starts flashing call your alarm monitoring company listed in section B of this manual. Also see "ERROR DISPLAY" page 11.

SPECIAL AREA PROTECTION

COMMAND

COMMAND

(#) (4) OR (#) (5)
OR (#) (6)

Special Areas may be armed by entering one of the Special Key Arming commands, if so programmed. When activated, the yellow *Alert* indicator light will flash on and off. Only User Code Numbers 26-30 may arm Special Areas. Special Area arming is independent of the entire system being armed.

AREA BYPASS

COMMAND BYPASS

(#) (9) [Area Nbr]

There may be occasions when it is desirable or necessary to temporarily bypass one or more areas prior to arming the system. For instance, a faulty detector causing a constant area alarm that can not be serviced until the next work day. If the green *Status* light is OFF press the [COMMAND/#] key to see which areas are alarmed and need bypassing.

Area bypassing is accomplished by entering [Command/#] [Bypass/9], then the 2-digit area number (01 through 14, the leading zero for areas 01 through 09 must be entered). Enter the command sequence only in the disarmed mode.

Only one area may be bypassed each time the command is used. If more than one area requires bypassing, repeat the command for each area that must be bypassed. (Please note that this command sequence will not affect the Fire Area.)

When one or more areas have been successfully bypassed, the yellow *Partial* light will pulse on and off to draw attention to the bypass, and will continue to pulse even when the control is armed.

If an area is already bypassed, re-entering the command will cancel the bypass for that area. Disarming the control will cancel all previously entered Area Bypass commands. To cancel all area bypasses while in the disarmed mode, enter [Command/#] [Bypass/9] [Reset/*].

NOTE: Whenever the command of [Command/#] [Bypass/9] is entered, the currently bypassed areas will be displayed in sequence as an S followed by the area number. (See Force Arming, Page 9, for another method of area bypassing.)

Warning: The user is cautioned that any area bypassing or force arming removes some of your protection. Therefore an intrusion may not be detected or that detection may be delayed. Use area bypassing and force arming with caution and always attempt to correct any area problems (open doors and windows etc.) before using these features. If the problem can't be corrected contact your alarm service company.

AREA TEST

COMMAND

TEST

ALL

(#) (8) (1)

The Area Test is used to assure detectors connected to an area will report an alarm condition back to the Control. While in Area Test, the green *Status*, yellow *Partial* and red *Armed* lights will pulse on and off together. Each detector should then be tested one at a time as instructed by the installing company.

While in Area Test, all control station sounders will turn ON continuously when any area detector is alarmed, and will remain on until all areas have been restored to a non-alarmed condition.

Area Test works on all burglary areas including those programmed Panic and 24 Hour. However, the Fire zone is not affected, and will function normally. While in Area Test, no Control alarms will occur with the exception of a fire alarm which will override the Area Test function.

Each time the Area Test sequence is entered, the display will show a U followed by the numbers (in sequence) of the untested areas. A U followed by two dashes (U - -) indicates all areas have been tested. While in the Area Test mode, any key except [Reset/*] may be pressed for a check on untested areas.

To exit the Area Test mode at any time, press [Reset/*].

CODE INFORMATION

System will support thirty (30) User codes which are assigned by you to employees and/or family members and may be any combination of Master, Temporary and Access Control codes. Each code may be from one to five digits in length.

For permanent codes, only your Master code may be deleted or changed. For temporary codes, you may delete or change other User codes, and this is done when the system is disarmed. Only one code can be assigned to a system, and of the 30 codes, the first code, or User Code Number 01, is the first code, or User Code Number 01. The factory shipped (default) Master Code is the four digit sequence of 1 2 3 4. This code should be changed to one of your personal preference, and programmed for arm and disarm with bypass privileges. Users codes should never be programmed to 1234 or 1111 as these are common defaults.

Permanent and Temporary codes may be programmed for Arm only; Arm only with bypass and Disarm only; or Arm and Disarm with bypass. While "Arm only" and "Arm only with bypass" codes cannot disarm the control, they can disarm fire alarms. All Permanent and Temporary codes should be programmed for at least three digits.

Temporary codes differ from Permanent in that Temporary codes will be disabled (cancelled) the next time a Permanent code is used to disarm the system. Temporary codes should not be programmed with bypass privileges.

The Duress code (or ambush code) will both disarm the system and report a silent duress alarm to a central station if you are subscribing to a monitoring service. The system will give no indication that a Duress code has been entered. (Review page 7, Duress Disarming for details.)

An Access Control code is used to apply operating power to access control devices such as electric door locks. (Review page 9, Access Control for details.)

NOTE: An attempt to program a user code to the same digits as an existing code, or one higher or lower than an existing code, will produce the three beep error tone, and will not change the code.

GENERAL CODE INFORMATION

Your system codes are assigned to family members, and each code may be permanent, temporary, or access control.

Of the User codes, the Master code is used to add, delete, or change codes. The Master code must be changed to a new code when the factory shipped Master code is changed to one of your personal preference. The factory shipped Master code is the four digit sequence of 1 2 3 4. This code should be changed to one of your personal preference, and programmed for arm and disarm with bypass privileges. Users codes should never be programmed to 1234 or 1111 as these are common defaults.

Both Permanent and Temporary codes may be programmed for Arm only; Arm only with bypass and Disarm only; or Arm and Disarm with bypass. While "Arm only" and "Arm only with bypass" codes cannot disarm the control, they can disarm fire alarms. All Permanent and Temporary codes should be programmed for at least three digits.

FORMAT FOR USER CODE CHANGES

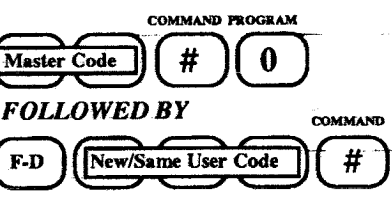

Master Code + [#] + [0] sequence is the display will remain blank. After the [0] has been depressed, however, data is prompted for entry as follows:

- 1. Enter 2-digit User Code Number (UCN) 01 thru 30
2. Enter Function Digit (F-D) 0 thru 9 shown to the right
3. Enter New/Same User Code followed by [Command/#]

F-D=8 is entered in response to the FUNC prompt, the display will show the code assigned to the User Code (UCN). If two dashes are displayed, then the User Code is 5 digits long. If the display shows "123-", then "123-45". Otherwise, the display will show "123-" with unprogrammed digits blank.

All User Code changes will follow the same basic format regardless of the change involved. First enter the present Master Code followed by [Command/#] [Program/0] [UCN] [F-D], the same or new User Code, and finally [Command/#].

[UCN] is the 2-digit User Code Number (each User Code is assigned a user code number from 01 to 30). A number may be assigned to only one code.

NOTE: User Code Number 01 is assigned to the Master Code.

The key [F-D] is the code's Function Digit defined as:

- 0 = Arm, only, with bypass privileges.
1 = Arm and disarm, with bypass privileges. (The Master Code requires F-D=1.)
2 = Temporary code; Arm, only, with bypass privileges.
3 = Temporary code; Arm and disarm, with bypass privileges.
4 = Arm, only, without bypass privileges.
5 = Arm and disarm, without bypass privileges.
6 = Temporary code; Arm, only, without bypass privileges.
7 = Temporary code; Arm and disarm, without bypass privileges.
8 = Not Used in User Codes. (See NOTE to lower, left.)
9 = Access code. Operate access control output.

Each User Code may be a new code just being programmed, or an existing code if the function of the existing code is being changed (e.g., removing bypass privileges). Attempting to assign the same User Code to two different UCNs will result in the error message display USED, it will be followed by Cdxx where xx is the User Code number that caused the conflict.

BASIC FORMATS

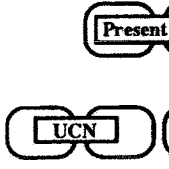

As the present code is being entered, the display will show [Program/0] key entry will be prompted for entry as follows:

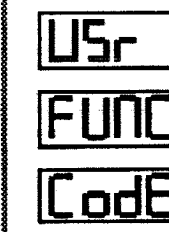

NOTE: If an F-D=8 is entered in response to the FUNC prompt, the display will show the code assigned to the User Code (UCN). If two dashes are displayed, then the User Code is 5 digits long. If the display shows "123-", then "123-45". Otherwise, the display will show "123-" with unprogrammed digits blank.

NOTE: 3 digits minimum are required for User Codes in Underwriter Laboratory (UL) Certificated installations.

TO CHANGE THE MASTER CODE

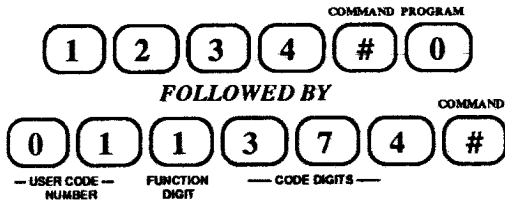

As an example, we wish to change from the 4-digit factory pre-set Master Code 1 2 3 4, to a new 3-digit Master Code 3 7 4.

As this is a master code, the User Code Number is 01 as previously defined (UCN=01).

We must also arm and disarm with bypass privileges as previously defined, so the Function Digit assigned is also 1 (F-D=1).

If entered correctly, a long beep will sound at the end of the complete sequence. Wait no longer than twenty (20) seconds between key presses when entering the new code information, or the three beep error tone will sound and the sequence will have to be restarted.

PROGRAM TEMPORARY USER CODE

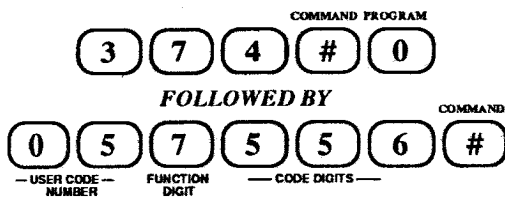

To create a temporary code (for use by the cleaners later in the evening), again start with the present Master Code followed by [Command/#] [Program/0] [UCN] [F-D], a new code for the cleaners, and finally [Command/#].

In this example, the Master Code is 3 7 4. We have previously assigned four other codes for regular use, so this will be the fifth code (UCN=05). We will allow the cleaners to arm and disarm, but not bypass (F-D=7), and they will be assigned the temporary user code of 5 5 6.

If entered correctly, a long beep will sound at the end of the complete sequence. The new temporary code may be used to arm and disarm the control any number of times, and will remain valid until the next time a permanent code is used to *disarm* the control.

MODIFYING A USER CODE

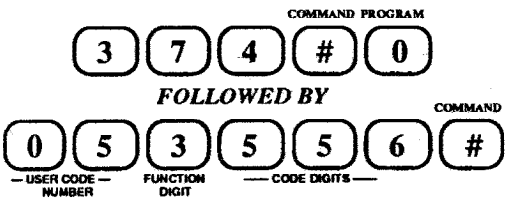

Just prior to leaving for the evening, we wish to upgrade the cleaners' temporary code to include bypass privileges. In effect, we wish to change the Function Digit from 7, to 3.

To do so, the sequence is the same as program temporary user code on the previous page, with the exception that [F-D]=3. Looked at another way, we could say we are creating a new User Code 05.

CANCELLING A USER CODE

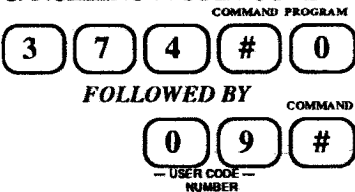

To cancel an existing code, enter the Master Code, [Command/#][Program/0] the User Code Number to be cancelled, and then [Command/#] again.

In this example, we wish to cancel user code number 09 which was a permanent code assigned to contractors doing work on the building.

NOTE: Master Codes can not be cancelled in this manner. Master Codes can be changed (as noted above) but not cancelled.

GENERAL PROGRAM INFORMATION

By use of your Master Code, you may enter and modify time-related programs to customize your system to fit your needs. These programs allow upgrading the control's internal clock to the current time, the day of the week and day of the year; opening and closing times; and automatic arming.

This is accomplished by first entering your master code at any control station when the control is disarmed. [Command/#] [Program/0] [Alert/7] are then entered to activate the Program Mode.

When the Program Mode is successfully entered, a long beep will sound, the green *Status*, yellow *Partial* and red *Arm* indicator lights will turn *on* continuous, and the display will show a colon (:).

At this time, program changes may be made.

As each completed change sequence is accepted by the control, a long beep will sound, and the program data will be recorded in memory. If an error is made (bad address, bad data value, or wrong number of data values), the three beep error tone will sound and the existing data in memory will not be changed.

After either the long acceptance beep or three beep error tone is sounded, the display will blank and the control is ready to accept the next entry.

Momentarily pressing [Reset/*] at any time in the Program Mode will cause the three beep error tone to sound, and cancels an entry sequence if not completed.

While in the Program Mode, the normal 5-second timer for keypad entries is disabled. However, if no keys are pressed for four (4) minutes, the three beep error tone will sound and the control will exit the Program Mode to the disarmed state. The 4-minute timeout is the only timer running in the Program Mode.

During the time the unit is in the Program Mode, the control will remain in an inactive state (complete disarm), **and will process no alarms including fire alarms.** When the Program Mode is exited, the control will return to the normal disarm state.

To cancel the Program Mode, simply press the [Reset/*] key for two (2) seconds, then release. The three beep error tone will sound when the key is first depressed, followed by a long acceptance beep when the key is released. When the Program Mode is successfully cancelled, the indicator lights will return to normal operation and the control will return to the disarm state.

BASIC FORMAT FOR PROGRAM CHANGES

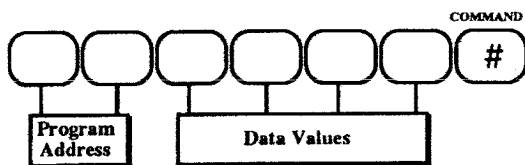

To engage the Program Mode for program changes, enter your Master Code and [Command/#] followed by [Program/0] [Alert/7]. Once in the Program Mode, all program changes will follow the same basic format for entry sequence. It may help to think of the entry sequence as consisting of three blocks of information; Program Address, Data values, and the sequence terminator.

The Program Address will always consist of the first two (2) digits of the sequence. These two digits are actually telling the control which program the changes are to affect.

The next four (4) digits are data entries necessary to provide the information for proper program execution.

The last digit of the sequence is the [Command/#] terminator which tells the control that input has ended, and to execute the change if valid. If the sequence is accepted by the control, a long beep will sound, the display will blank and the program data will be stored in memory. Errors will result in the three beep error tone, the program will not store and the entries will have to be repeated.

CHANGING CURRENT TIME

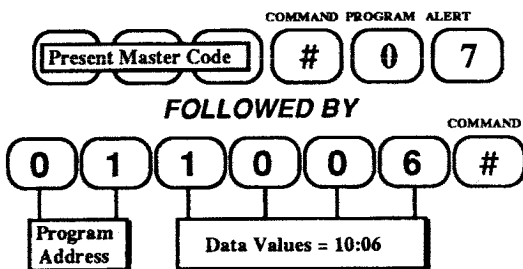

The example to the left shows the entire sequence needed to set the control's internal clock to 10:06 AM. (For detailed variations on time of day, please consult Section I.1, *Current Time Programming*.)

Master Code +

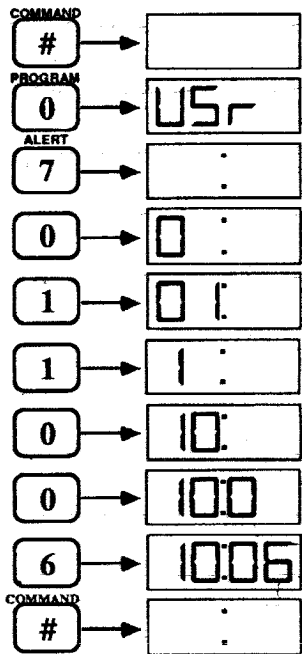

After entering your Master Code and [Command/#], the display will remain blank.

Entering [Program/0] will put the control into the Program Mode for User Code changes,

and entering [Alert/7] will then activate the Program Mode for program changes. The display will first display a colon (:).

The next two digits entered are a zero and a one [0] [1] which tells the control that program 01 is to be changed.

The next four digits are the data values that tell the control to set the internal clock to 10:06 AM (24 hour format).

The final key is the [Command/#] terminator. When entered, the clock will set to 10:06 AM, and the display will again show a colon (:). At this point, another program may be changed (without having to again enter your Master Code), the program may be "read back" on the display to verify correctness, or the Program Mode may be terminated.

READ BACK DISPLAY

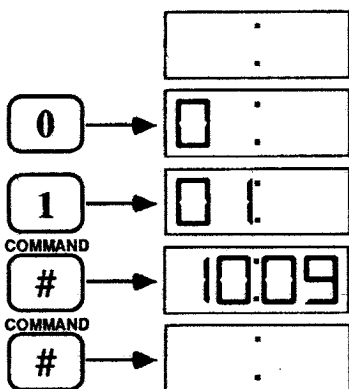

Program data information, once entered and accepted by the control, can be recalled to the display for verification at any time while in the Program Mode. Starting with the colon display (:), first enter the 2-digit program address for the program you are interested in, then immediately terminate with the [Command/#] key. The display will then indicate the present status of the program data.

(If starting from the disarmed state, enter your Master Code, then [Command/#] [Program/0] [Alert/7], the 2-digit program address you are interested in, and then [Command/#].)

The example to the left shows the read back verification for the example used on the previous page. The read back was three minutes after the clock was set (10:06 AM), and we have a display showing a verification that the clock is running as expected (10:09 AM).

Pressing the [Command/#] key one more time will return the display to the colon (:).

CANCEL THE PROGRAM MODE



To cancel the Program Mode, press and hold the [Reset/*] key for two (2) seconds, then release. A long beep after the key is released will signal cancellation of the Program Mode, and the control will return to the disarmed state.

1

PROGRAM DETAIL GUIDE - MASTER CODE ACCESS

I.1 CURRENT TIME PROGRAMMING

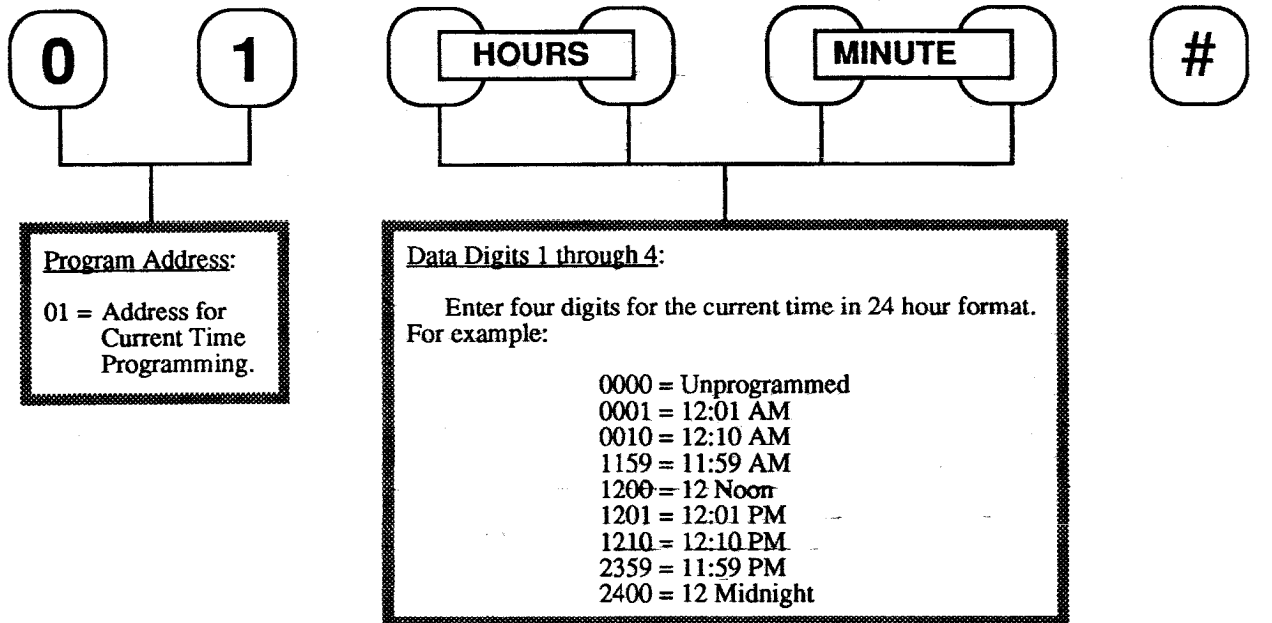

EXAMPLE

IF IN THE USER PROGRAM MODE*, ENTER

0 **1** **1** **4** **3** **8** **COMMAND #**

PROGRAM ADDRESS **1438 = 2:38 PM**

The above input sequence will program the control to the current time of day which, we hope, is 2:38 PM.

*IF NOT IN THE USER PROGRAM MODE, FIRST ACTIVATE MODE BY ENTERING

Present Master Code **COMMAND PROGRAM ALERT # 0 7**

NOTE:

On a total power failure (AC failure and battery loss) the time of day, day of the week and history buffer will be lost and they must be set either from the keypad or the remote programmer, if these functions are desired.

The control will not automatically compensate for shifts in time due to switches between Standard and Daylight Savings time. Use Program 01 or the remote programmer to reset to the new time for each change into and out of Daylight Savings.

I.2 CURRENT DAY OF WEEK PROGRAMMING

COMMAND

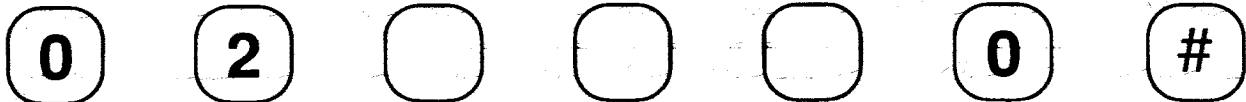

Program Address:
02 = Address for Day of Week Programming.

Data Digit 1:
Enter one digit for the current day as follows:
0 = Disabled
1 = Monday
2 = Tuesday
3 = Wednesday
4 = Thursday
5 = Friday
6 = Saturday
7 = Sunday
8, 9 = Invalid

Data Digit 4:
0 = Always enter as zero
1 = Invalid
2 = Invalid
3 = Invalid
4 = Invalid
5 = Invalid
6 = Invalid
7 = Invalid
8 = Invalid
9 = Invalid

Data Digit 3:
User Code reports:
0 = All User Codes are reported
1 = User Code 01, only, does not report
2 = User Codes 01 and 02, only, don't report
3 = User Codes 01 through 03 don't report
4 = User Codes 01 through 04 don't report
5 = User Codes 01 through 05 don't report
6 = User Codes 01 through 06 don't report
7 = User Codes 01 through 07 don't report
8 = Invalid
9 = Invalid

Data Digit 2: (See "Automatic Arming" in Section K)
"Failure to Close (Late)" 2-second tone warning
0 = Disable 15, 10 and 5 minute Warning Tones
1 = Enable 15, 10 and 5 minute Warning Tones for Failure to Close (Late)
2 = Enable 15, 10 and 5 minute Warning Tones for Automatic Arming
3 = Enable 15, 10 and 5 minute Warning Tones for Failure to Close (Late) and Automatic Arming
4, 5, 6, 7, 8, 9 = Invalid

EXAMPLE

The input sequence to the right will program the control to Tuesday (which should be the current day of the week).
The 2-second "Failure to Close (Late)" warning tones will also sound if the control is disarmed, and the Closing Window approaches 15, then 10, then 5 minutes of the end of the time period.

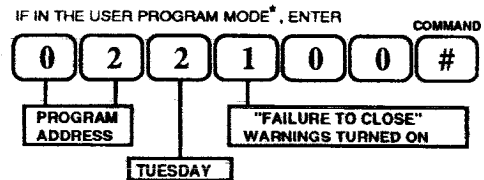

*IF NOT IN THE USER PROGRAM MODE, FIRST ACTIVATE MODE BY ENTERING
Present Master Code # 0 7

I.3 OPENING and CLOSING WINDOW LENGTH
 (0 Minutes Min., 240 Minutes Max. Allowed for each window length)

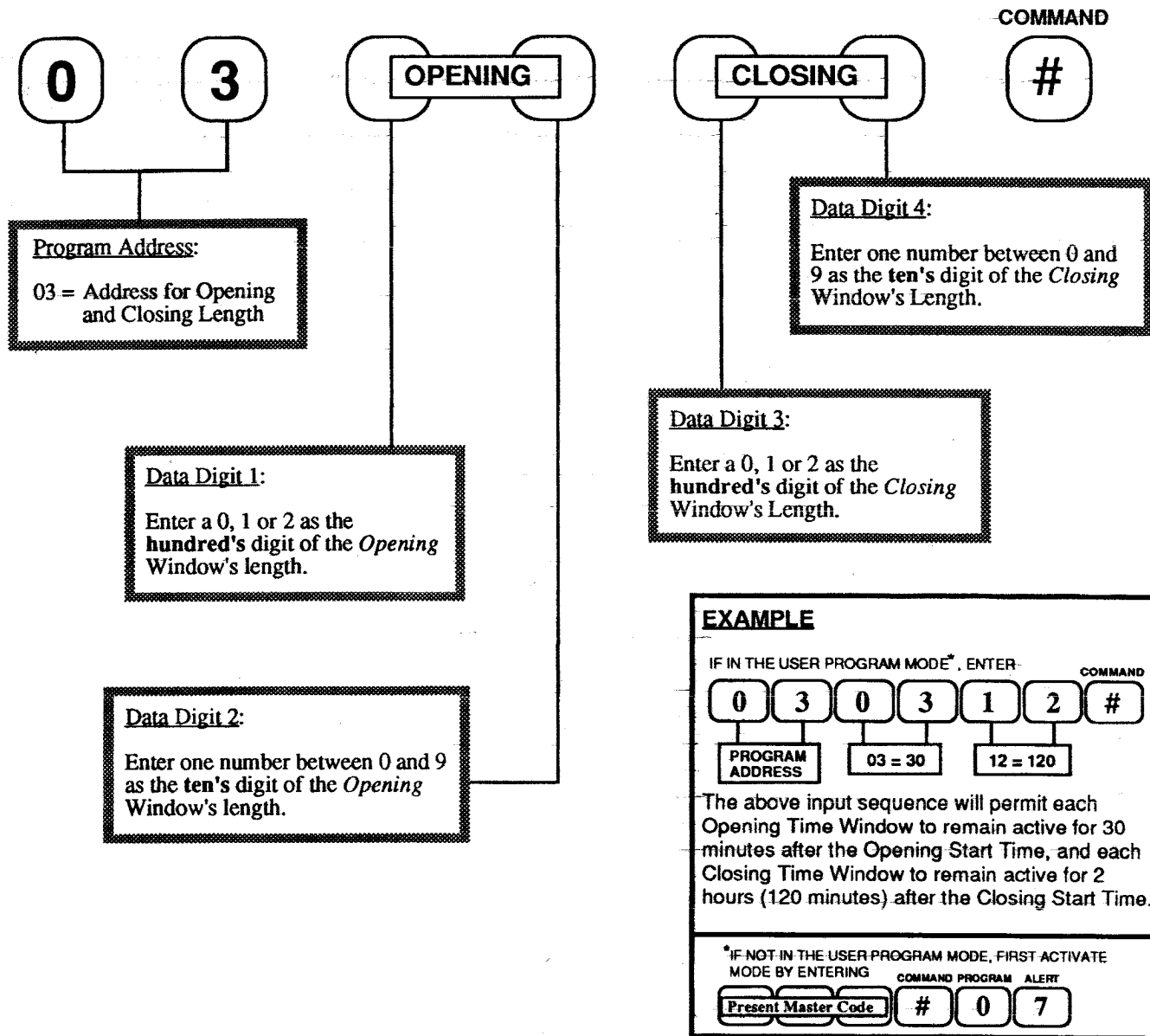

NOTE:

Openings and closings consist of time periods called "Windows", with each window composed of a start time and a length.

The start time determines the time of day the window will activate, while the length determines how long the window will remain active. Openings and closings that occur during the appropriate windows are not reported as these are normal occurrences. However, openings and closings that occur outside of these windows will be reported if such reports are programmed.

Setting the window length = 0 will cause Failure (late) open and close reports to occur at the window start time, without suppressing any open or close reports.

Failure (late) to open or close during the appropriate window may also be reported.

See Section I.5 for Start Time programming.

See Section I.2 for Failure (late) to close warning siren.

I.4 AUTOMATIC ARMING TIME

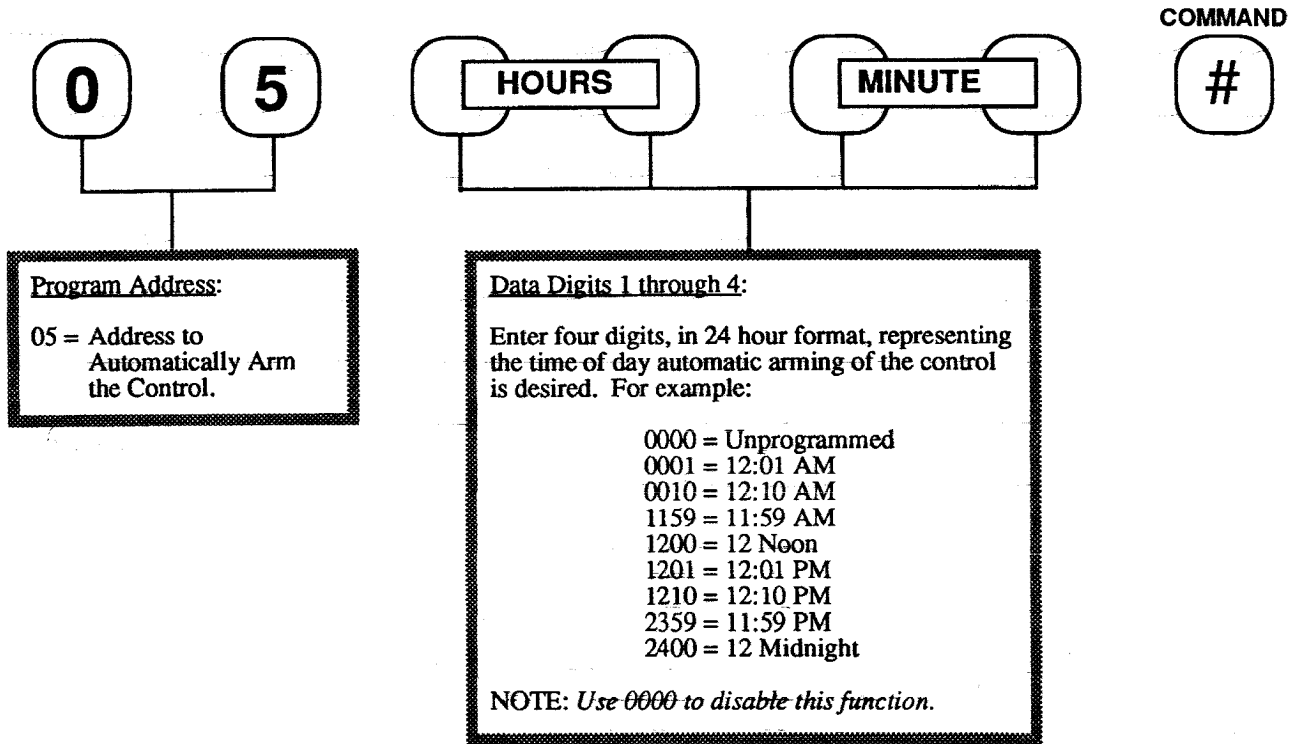

NOTE: (See, also, "Auto Arming" in Section K)

The Automatic Arm program, if employed, will not rearm an already armed control.

If one or more areas are violated at time of automatic arming, Program 05 will force arm the Control, and has precedence over the maximum number of bypassable areas.

In other words, if is programmed to only permit a maximum of two bypassed areas to allow force arming, and four areas are violated at time of automatic arming, Program 05 will force arm by bypassing the four violated areas.

Program 05 will also force arm the Control even if one or more violated areas have been programmed "Unbypassable".

Automatic Arming will show as Arming Level 8 and Users Code 98 in the history display.

EXAMPLE

IF IN THE USER PROGRAM MODE*, ENTER

0 5 2 1 3 0 #

PROGRAM ADDRESS 2130 = 9:30 PM

The above input sequence will automatically arm a ~~disarmed~~ control at 9:30 PM. Just prior to arming, a 2 second warning will sound from all system sounders and sirens. Pre-arm warnings will also sound at the 15, 10 and 5 minute time periods if so programmed by Program 02.

*IF NOT IN THE USER PROGRAM MODE, FIRST ACTIVATE MODE BY ENTERING

Present Master Code # 0 7

I.5 OPENING and CLOSING START TIMES

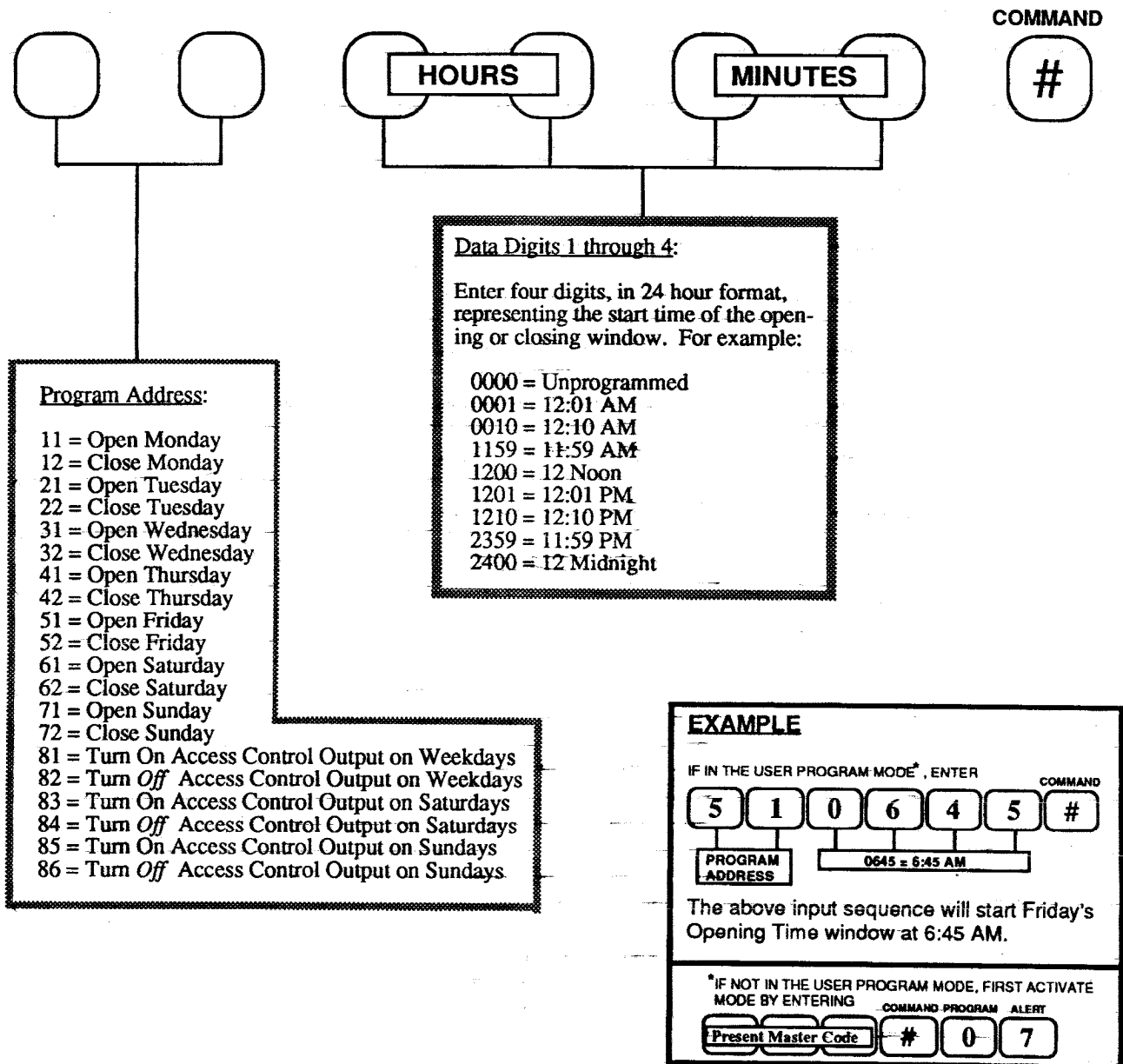

NOTE:

Openings and closings consist of time periods called "Windows", with each window composed of a start time and a length.

The start time determines the time of day the window will activate, while the length determines how long the window will remain active. Openings and closings that occur during the appropriate windows are not reported as these are normal occurrences. However, openings and closings that occur outside of these windows will be reported if such reports are programmed.

Setting the window length = 0 will cause Failure (late) open and close reports to occur at the window start time, without suppressing any open or close reports.

Failure (late) to open or close during the appropriate window may also be reported.

See Section I.3 for window length programming.

See Section I.2 for Failure (late) to close warning siren.

HISTORY DISPLAY INFORMATION

GENERAL

Control Unit activity events are kept in an electronic file called a "History Buffer", which will store a total of 96 events.

When power is first applied to the unit, the history buffer is empty. As activities occur, they are stored in the buffer until a total of 96 events are present. At that point, as each new event occurs, it is stored as the most recent causing the oldest event to be erased.

Entering [Command/#]-[Test/8]-[Bypass/9] while the control is *disarmed* will play back the contents of the history buffer starting with the most recent event.

Each stored event consists of three (3) displays which are shown in the following order by momentarily depressing the [Command/#] key after each display;

- type of event
- day of the week, with information descriptor based on the type of event
- time of the event in 24 hour format

If the delay between [Command/#] key presses is greater than 40 seconds, the display will blank, the three beep error tone will sound, and the control will return to the normal disarmed state. The history display may also be cancelled by depressing the [Reset/*] key.

Although not shown in this section the system trouble (error) displays (see Section I) will also be recorded in the history in the same format as the other displays below. They are:

- AC failure - "AC F"
- Communicator error - "C Er"
- Low battery - "Lo b"
- EEPROM error - "EE P"

ACTIVITY DISPLAY INFORMATION

ALARM

ALARM

Indicates a Zone alarm (Zones 1 through 14, but not the Fire Zone), including a Day Monitor alarm.

WE 6

Second Display = Day of the week, and violated zone.
(Shown is Wednesday, Zone 6)

2:56

Third Display = Time Event Occurred
(Shown is 2:56 AM)

CLOS

CLOSE (ARM)

Indicates a Closing (Control was armed).

TU 4

Second Display = Day of the Week, and Arming Level (the number of the key used to arm the system).
(Shown is Tuesday, and key [4])

UC 1

Commercial Mode, only

Special Display = User Code Number used to arm the system. Consists of the letters UC, and the 2-digit User Code Number where UC 98 = Auto Arm or remote arm, and UC 99 = Keyswitch Arm.

17:58

Third Display = Time Event Occurred
(Shown is 5:58 PM)

EMER

EMERGENCY

Indicates emergency alarm activated by a Special key program [B].

FR 0

Second Display = Day of the Week
(Shown is Friday, with the [B] key having been used)

12:00

Third Display = Time Event Occurred
(Shown is 12 Noon)

FIRE ALARM

Indicates fire alarm activated by a Special key program [A].

Second Display = Day of the Week.
(Shown is Monday, with the [A] key having been used)

Third Display = Time Event Occurred
(Shown is 6:10 AM)

FIRE ALARM

Indicates a zone fire alarm.

Second Display = Day of the Week, and violated zone.
(Shown is Saturday, Zone 15)

Third Display = Time Event Occurred
(Shown is 1:59 PM)

SILENT ALARM

Indicates a silent alarm activated by a Special key program [C].

Second Display = Day of the Week.
(Shown is Sunday, with the [C] key having been used)

Third Display = Time Event Occurred
(Shown is 11:59 AM)

OPEN (DISARM)

Indicates an Opening (Control was disarmed).

Second Display = Day of the Week, and User Code Number used to disarm the control, where User Code 98 = Remote Disarmed and User Code 99 = Keyswitch Disarmed.
(Shown is Thursday, and User Code Number 03.)

Third Display = Time Event Occurred
(Shown is 11:59 PM)

PrOL

PROGRAM MODE ENTERED LOCALLY

The L after Pro indicates the program mode was entered locally using a Control Station.

PrOr

PROGRAM MODE ENTERED REMOTELY

The r after Pro indicates the program mode was entered from a remote location such as a Central Station download via telephone lines.

SA 15

Second Display = Day of the Week, and type of programs changed. (shown is Saturday with Special arming, user codes and reports changed.)

The local programming code for the first digit (tens digit) of the program change is:

- 1 = Special Arming Changed
- 2 = General Control Changed
- 3 = 1 and 2 above
- 4 = System Timers Changed
- 5 = 1 and 4 above
- 6 = 2 and 4 above
- 7 = 1 and 2 and 4 above.

The local programming code for the second digit (units digit) is:

- 1 = Reports, Phone Number or Account Codes Changed
- 2 = Intrusion or Fire Zone Parameters Changed
- 3 = 1 and 2 above
- 4 = Programmer or User Codes Changed
- 5 = 1 and 4 above
- 6 = 2 and 4 above
- 7 = 1 and 2 and 4 above.

The remote programming codes are:

- 70 = Changed any parameter
- 71 = Set back to default parameters

13:59

Third Display = Time Event Occurred (Shown is 1:59 PM)

FSHU

FORCE SHUNT Indicates a zone has been force armed.

SHUN

SHUNT Indicates a zone has been bypassed.

Fr 6

Second Display = Day of the Week, and Bypassed Zone. (Shown is Friday, Zone 6)

NOTE: Bypass events are stored only when arming the control, and they display after the arming event. Force arming the control will record all bypassed zones as if they were entered individually. 24 Hour zone bypasses are stored as they occur.

12:01

Third Display = Time Event Occurred (Shown is 12:01 PM)

UNSH

UNSHUNTED

Indicates a 24 Hour zone has been unbypassed.

Fr 5

Second Display = Day of the Week, and unshunted Zone. (Shown is Friday, Zone 5)

NOTE: Zone unshunting is stored only when a 24 Hour zone is involved.

12:01

Third Display = Time Event Occurred (Shown is 12:01 PM)

CHARACTERS and OTHER DISPLAYS USED

some keypad models do not have this 4 character display

SA = Saturday
 SU = Sunday
 MO = Monday
 TU = Tuesday
 WE = Wednesday
 TH = Thursday
 FR = Friday

ALAr = Alarm
 CHEC = Check
 CODE = Code
 Er r = Error
 FAUL = Fault
 FUNC = Function
 FirE = Fire
 OFF = Off
 ON = On
 Prob = Problem
 USED = Used
 USr = User

A = A
 C = C
 D = D
 E = E
 F = F
 H = H
 I = I
 L = L
 M or N = M or N
 O = O
 P = P
 R = R
 S = S
 T = T
 U or W = U or W
 0 = 0
 1 = 1
 2 = 2
 3 = 3
 4 = 4
 5 = 5
 6 = 6
 7 = 7
 8 = 8
 9 = 9

AC F = AC power Failure.
 ALAr = Alarm.
 Cd = Code conflict (followed by user code number).
 C Er = Communicator Failure.
 CHEC = Check. Indicates which zones must be violated, before the system is armed, as a check to assure that zones are in operating order.
 CODE = Code. A prompt to enter the new User's Code.
 EE P = Error. Indicates that an error exists in the control's program memory.
 Err = Error. Indicates a time-out or an error in the User's operation of the Control, and is accompanied with the 3 beep error tone.
 FAUL = Fault. Indicates that a zone, programmed for a trouble indication, is shorted, or a zone *not* programmed for a trouble indication, is open or shorted.
 FirE ALAr = Fire Alarm (see fire reset).
 FirE Prob = Problem in the fire circuit. May be due to an improperly connected component or detector, a missing detector (removed for cleaning?), or a broken wire. When trouble is detected, the sounder will beep every five seconds, and the words FirE followed by Prob will display. You should first determine and correct the problem, then enter your disarm code to silence the sounder.

FUNC = Function. A prompt to enter a code's Function Digit (F-D).
 HOLD = Hold the key for 2 seconds to create emergency, fire or medical keypad alarms.
 Lo b = Low Battery. Indicates a problem with the standby battery power.
 OFF = Off. Indicates that an Access Control code was entered to turn off Access Control Power.
 ON = On. Indicates that the Access Control code was entered to pulse or operate Access Control Power.
 Prob = Problem. Indicates a burglary zone, programmed for a trouble indication, is open. If preceded by FirE, then fire zone is open.
 S = Shunt (bypass). Displayed with a number to indicate a shunted (bypassed) zone.
 U = Zone Test. When displayed with a number, indicates an untested zone. When followed by two dashes, indicates all zones have been tested.
 USEd = Used. Indicates a User Code has been entered that matches an existing one. The following "Cd" display shows which user code the conflict occurred with.
 USr = User. A prompt to enter the User Code Number (UCN).

GLOSSARY

ACCESS CODE/ACCESS CONTROL:

One or more – up to 29 – User Codes can be programmed as Access Control Codes. These codes are programmed as shown in section H, and require a Function Digit of 9.

Access control requires that an optional relay be installed in your 7100. Please contact your security installation company for both installation of the relay and programming of the control necessary for the relay's operation.

The relay can be programmed to switch states (open an electric door strike, for example) for any time between 1 and 255 seconds before returning to its original state. The relay is operated by entering an Access Control code at any Control Station.

The relay can also be programmed to switch states and hold the new state until the next time the Access Control code is again used. This allows the relay to be "turned on and off" once a day, for instance, to control outside lighting, heat setback, etc..

Each time the Access Control code is entered at a control station, the state the relay is going to will be displayed (ON/OFF).

AUTOMATIC ARMING:

The control can be set to automatically arm itself at a preset time of day as shown in section I.6. This is a very useful feature for large installations where flexible work schedules require different users to arm the system at different times from day to day. In this scenario, it is possible that the last person could leave the building believing someone else is still on the premises.

If the control is disarmed at the programmed automatic arming time, the control will arm with the normal exit delay. As a warning to anyone still on the premises, the alarm sounding devices will sound for two seconds. The exit delay time, if long enough, will permit anyone remaining to disarm the control if they have a User Code with disarm privileges. As an added precaution, the control can be programmed (section I.6, data digit 2) to activate alarm sounding devices for 2 seconds at 15, 10 and 5 minutes prior to the time set for automatic arming.

If one or more areas are in alarm when the system automatically arms, they will be force armed. This will occur even if an alarmed area is programmed nonby-passable (e.g., main entrance), or the number of areas exceeds the programmed number of areas that can be force armed. This override feature permits the maximum protection possible under the circumstances. If connected to a monitoring service, your security installing company can program the control to issue trouble reports at the time of automatic arming.

COMMUNICATOR TEST:

This test is available only if your system transmits alarms and system information to a monitoring service, and has been programmed by the security installing company to permit communicator tests. If so programmed, then a [COMMAND/#] [Test/8] [Instant/2] sequence entered at a control station will generate a test report.

The green Power indicator light on the control station will pulse on and off during the test. If the report is successful, the power indicator light will return to normal and a long sounder beep will be heard.

If the communication is unsuccessful, the power indicator light will continue to pulse and the sounder will come on continuously. Pressing [RESET] will quiet the sounder, but a communication error will appear in the history buffer. Should this occur, contact your installing company as soon as possible.

DAY MONITOR ZONES:

A area, programmed for day monitor by your installing company, will remain "active" even when the control is disarmed. This feature can be used to monitor areas requiring high security such as tobacco or drug store rooms, gun and liquor cabinets, classified document rooms, and other such areas that would not be entered during the normal course of business.

If an area is programmed for day monitor protection, any violation of that area while the control is disarmed will cause the control station sounders to sound continuously. An indication of an alarm will also appear in the history buffer.

In the event there are more than one day monitor area in your system, pressing the [COMMAND/#] key will display ALAr followed by the violated area number. The sounders may be silenced by entering a valid disarm users code.

No central station report will be made for a day monitor area violation.

DIAL TONE TEST (RINGBACK):

If connected to a monitoring service via telephone lines, your control may be programmed to test for the presence of the phone line each time you arm the system. When so programmed, a beep will occur only after the closing report is received at the central station (called, "Ringback"). The exit delay timer will not start until the beep is heard or a communicator failure is detected. Although the control may not be able to communicate with the monitoring service, local alarm annunciation is still afforded.

The control may also be programmed to operate the alarm sounding devices for two seconds at the same time that the sounder beeps a ringback. If the ringback test fails, no beep or alarm sounding device will be heard.

FIRE ALARM:

In the event of a fire alarm, the alarm sounding devices will activate and the control stations will display **FirE** followed by **ALAr**.

The alarm sounding devices must be silenced before resetting the fire circuit.

To silence the alarm sounding devices, enter a user code with disarm privileges. The **FirE ALAr** display, however, can only be cancelled by resetting the smoke detectors. Use **[COMMAND/#] [TEST/8] [PROGRAM/0]** to reset the smoke detectors and cancel the **FirE ALAr** display. **Always locate the smoke detector in alarm before resetting the fire alarm circuit.**

FIRE TROUBLE:

A fire trouble signal will sound if a break occurs in the fire loop or one or both sides of the fire loop are grounded. The "break" could be a physical break in the wiring, a loose terminal, or even a disconnected smoke head.

If a fire trouble occurs, the keypads will display **FirE** followed by **Prob**, and the control station sounders will sound a short beep every five seconds.

To silence the sounders, enter a user code with disarm privileges. The **FirE Prob** display, however, will continue until the cause of the trouble is found and corrected, and a user code with disarm privileges is entered.

FORCE ARM:

Under normal circumstances, if one or more areas are violated (in alarm), the green *Status* indicator light will be off, and the control will refuse to arm when an arming command is entered. This is to prevent an armed control from going into alarm (because of the violated area) as soon as the exit delay period expires.

Your control, however, may be programmed to allow force arming (section D). If provided, entering the Force Arming command will force the control to automatically bypass the violated areas and ignore any alarms from them. There may be a limit on the number of areas that may be bypassed during force arming. If this number is exceeded, force arming will not work.

When force arming is allowed, and an arming command is entered with the green *Status* light off, the control station sounder will beep for five seconds. If the **[BYPASS/9]** key is then pressed during the five second beep, the control will be forced armed. Otherwise, the control will not arm. If also so programmed, your control may then transmit reports to your monitoring service indicating a non-normal closing condition.

INVISIBLE AREA:

Areas programmed as invisible by your installing company will remain "active" even when the control is disarmed. These areas are intended for use with such items as money clips, silent hold-up buttons and similar applications, and for systems that are connected to a monitoring service.

When an alarm occurs in an area that is programmed invisible, there is no outward indication that the area has alarmed. The area will not activate alarm sounding devices, and even the green *Status indicator light* will continue to remain on. Alarms, however, will be transmitted to the monitoring service.

SPECIAL AREA PROTECTION:

The concept of Special Area Protection permits users having certain user codes to arm only a portion of the premises while maintaining an unarmed status in the remainder of the premises. An example of a special area could be one or more drug and/or tobacco storage rooms in a large store.

Any combination or compliment of areas may be programmed by your installing company as a special area. When one or more areas are programmed as Special Area areas, only User Codes 26 through 30 may bypass, arm or disarm the special area. Arming the Special Area areas (only) also requires use of one of the special function key [4], [5] or [6] arming commands.

In operation, any user code may arm the control using the standard [COMMAND/#] [All/1] arming command sequence, and all protection **Including the special area areas** will arm. When armed in a standard manner, all control station indicator lights will follow their normal pattern.

If a non-special area user (Codes 1 through 25) then disarms the control, the red *Armed* indicator light will turn off, the yellow *Partial* indicator light will be off and the green *Status* indicator light will follow the current area status. These indicator light responses are normally expected after disarming the control. However, the yellow *Alert* indicator light will start flashing to indicate that the special area is still armed, and any violation of the special area at this point will cause an alarm.

When a special area user (codes 26 through 30) enters the building, entering their user code will disarm the special area protection and stop the yellow *Alert* indicator light from flashing.

If special area users desire to rearm the special area without rearming the entire system, they would use the special arming key [4], [5], or [6] sequence instead of the standard [COMMAND/#] [All/1]. This will start the yellow *Alert* indicator light flashing and arm only the special area areas.

AREA STATUS DISPLAY:

One special optional feature of the 7100 allows the control station display to continuously indicate which areas are in alarm while the control is disarmed.

When programmed for this feature, the horizontal bars which are part of the four digit display will light up when the areas that they represent are in alarm. The display only appears when the control is disarmed. To save standby battery life, the Area Status Display is disabled during AC power failures.

In the display below, the numbers on the bars indicate the assigned area. The one exception is that if areas 12, 13 or 14 is faulted, only bar 12 will light.

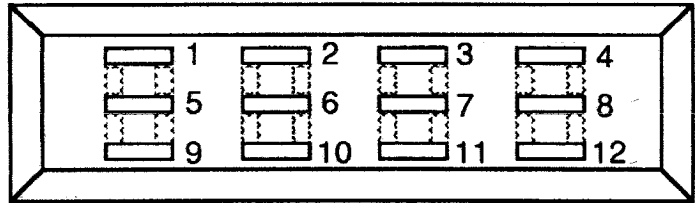

Finally, there is no real need to memorize which bar corresponds to which area, since pressing the [COMMAND/#] key at any time in the disarmed mode will show which areas are presently in alarm.

PROGRAM WORKSHEET

Use this worksheet to record final time settings.

CURRENT TIME - SECTION I.1

0 1 Cmd #

CURRENT DAY OF WEEK - SECTION I.2

0 2 Cmd #

OPENING & CLOSING RUN TIMES - SECTION I.5

0 3 Cmd #

CURRENT DAY OF YEAR - SECTION I.4

0 4 Cmd #

AUTOMATIC ARMING - SECTION I.6

0 5 Cmd #

MONDAY OPEN TIME - SECTION I.4

1 1 Cmd #

MONDAY CLOSE TIME - SECTION I.4

1 2 Cmd #

TUESDAY OPEN TIME - SECTION I.4

2 1 Cmd #

TUESDAY CLOSE TIME - SECTION I.4

2 2 Cmd #

WEDNESDAY OPEN TIME - SECTION I.4

3 1 Cmd #

WEDNESDAY CLOSE TIME - SECTION I.4

3 2 Cmd #

THURSDAY OPEN TIME - SECTION I.4

4 1 Cmd #

THURSDAY CLOSE TIME - SECTION I.4

4 2 Cmd #

FRIDAY OPEN TIME - SECTION I.4

5 1 Cmd #

FRIDAY CLOSE TIME - SECTION I.4

5 2 Cmd #

SATURDAY OPEN TIME - SECTION I.4

6 1 Cmd #

SATURDAY CLOSE TIME - SECTION I.4

6 2 Cmd #

SUNDAY OPEN TIME - SECTION I.4

7 1 Cmd #

SUNDAY CLOSE TIME - SECTION I.4

7 2 Cmd #

WEEKDAY ACCESS CONTROL ON AT - SEC. I.4

8 1 Cmd #

WEEKDAY ACCESS CONTROL OFF AT - SEC. I.4

8 2 Cmd #

SATURDAY ACCESS CONTROL ON AT - SEC. I.4

8 3 Cmd #

SATURDAY ACCESS CONTROL OFF AT - SEC. I.4

8 4 Cmd #

SUNDAY ACCESS CONTROL ON AT - SEC. I.4

8 5 Cmd #

SUNDAY ACCESS CONTROL OFF AT - SEC. I.4

8 6 Cmd #

INDEX

24 Hour Zones	1, 12, 24	History	9, 22, 23, 24
A Key	1, 10	HOLD Message	25
AC F Message	11, 25	Indicator Test	11
Access Control	9, 13, 21, 26	Instant Alarm	4
Access Control Code	9, 13	Interior Zone	4, 5
ALAr Message	22, 25, 26, 27	Invisible Zone	27
Alert	3, 7, 9	Keypad, Control Station	3, 2, 7, 9
Alert Indicator, Yellow	2, 3, 4, 9, 12, 28	Keypad Entry Errors	9, 25
Area Bypass	12	Lo b Message	10, 11, 25
Area Status Display	28	Master Code	13, 14, 15, 16
Area Test	3, 12	NEd Display	23
Arm, Armed, Arming	2, 3, 4, 5, 6	OFF Message	25, 26
Armed Indicator, Red	2, 3, 4, 5, 7, 15, 28	ON Message	25, 26
Arming, Automatic	6, 20, 22, 26	OPEN Message	23
Arming, Default	4	Opening Window Length	19
Arming, Forced	6, 24, 26, 27	Opening Start Time	21
Arming, Perimeter/Delay	5	Partial Indicator, Yellow	2, 3, 4, 5, 12, 15, 28
Arming, Perimeter/Instant	4	Perimeter	4, 5
Arming, Special Key	5	Permanent Code	13
B Key	1, 10	Power, AC Power	3, 11, 22
Battery, Standby	10, 11, 22	Power Indicator, Green	2, 3, 5, 10, 11, 26
Battery Test	10, 11	Prob Message	25, 27
Bells	1, 2	Program Address	15, 16
Bypass	3, 6, 12, 13, 14, 24, 27	Program Mode	3, 15, 16
C Key	1, 10	ProL Display	24
Cdxx Message	13, 25	Pror Display	24
C Er Message	10, 11, 25	Read Back	15, 16
CHEC Message	25	Remote Program Dialout	11
CLOS Display	22	Remote Programming Enable	11
Closing Start Time	21	Ringback	4, 27
Closing Window Length	19	S Message	12, 25
CodE Message	13, 25	SHUN Display	24
Communicator Test	10, 26	Silence Alarms	8, 27
Control Station	2, 3, 7, 9	Silent Alarm	1, 10
Current Time	17	Siren, Siren Voltage	1, 2
Custom Arm	5	Smoke Detector Reset	8, 10, 11, 27
Day Monitor	26	Sounder	2, 6, 7, 8, 9, 10, 12, 15, 26, 27
Day Of Week	18	Sounder Test	12
Default Users Code	13	Special Area	12, 28
Dial Tone Test	4, 27	Special Key [4]	5, 28
Disarm, Disarmed, Disarming	3, 7, 8, 13	Special Key [5]	5, 28
Duress Alarm	7, 13	Special Key [6]	5, 28
Duress Code	7, 13	Status Indicator, Green	2, 3, 4, 5, 6, 12, 15, 27, 28
EE P Message	11, 25	Temporary Code	13, 14
Emergency Alarm	10	Time Of Day	17
Emergency Keypad Alarms	8, 10	Timer, 4 Minute	15
ENE Display	22	Timer, 5 Second	15
Entry Delay	7	U Message	12, 25
Entry/Exit Zone	4, 5	UNSH Message	24
Err Message	8, 25	USEd Message	13, 25
Error Display	11	User Code	13, 14, 26, 27, 28
Exit Delay	3, 4, 5, 27	User Code Number (UCN)	13, 14
FAUL Message	25	USr Message	13, 25
Fire Alarm	1, 8, 11, 23, 25, 27	Warning Tones	18
FirE Message	23, 25, 27	Windows, Opening and Closing	19, 21
Fire Trouble	25, 27		
Force Arm	6, 27		
FSHU Message	24		
FUNC Message	13, 25		
Function Digit (F-D)	13, 14		